

VCTB-4000 Four Zone, 24 Volt DC Valve Gate Controller

And Accessories VCTBA-01 thru -05

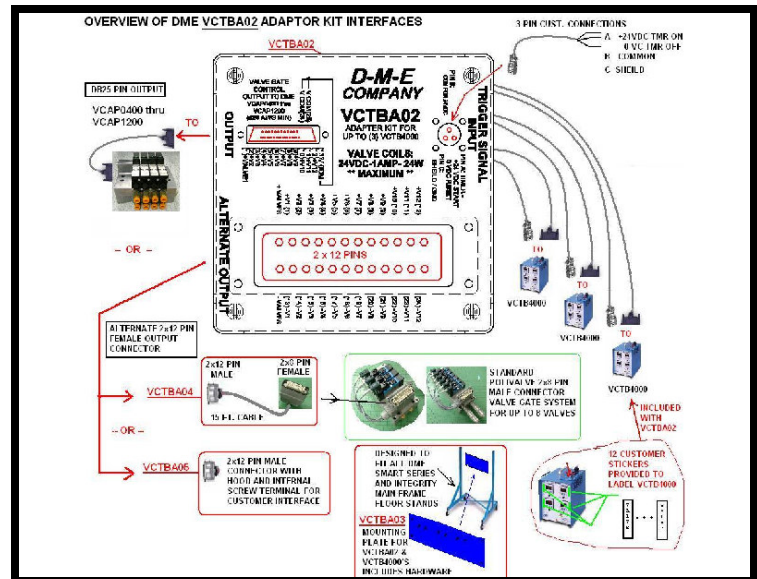
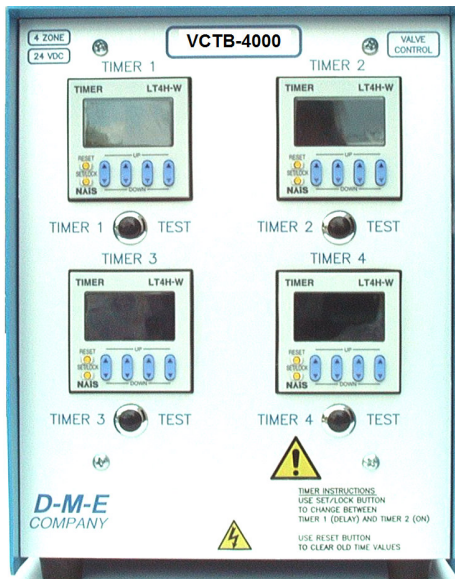

User Manual D-M-E Company

SAFETY

D-M-E Company products have been designed to be safe and simple to operate. As with any electronic equipment, you must observe standard safety procedures to protect both yourself and the equipment.

To Prevent Injuries:

- To avoid electrical shock or fire hazard, do not apply voltage to a terminal that exceeds the range specified for that terminal.
- To avoid mechanical injury, electrical shock or fire hazard, do not operate this product with covers or panels removed.
- To avoid electrical shock or fire hazard, do not operate this product when wet.
- To avoid injury or fire hazard, do not operate this product in an explosive atmosphere.
- To avoid burn hazards, do not operate valve gates with operator gates open. Correct hookup of valve gates should only be performed with all operator guards in place.
- To avoid burn hazards and possible damage to equipment, do not leave hot runner systems at elevated temperature for extended periods of time. When the mold and machine are not operating, disconnect the molding machines injection unit from the hot runner system so that pressure may discharge through the sprue or manifold extension nozzle. Make sure the molding machines purge guard is in place.

To Prevent Product Damage:

- Do not operate this product from a power source that applies more than the voltages specified.
- Do not apply any external voltage to the injection forward input. Only a contact closure or solid state relay should be used as an input.

DME RIGHTS

Copyright © D-M-E Company 2004. All rights reserved.

D-M-E Company products are covered by USA and foreign patents, issued and pending. Information in this publication supersedes that in all previously published material. Specifications and any changes are reserved.

Printed in the United States of America

D-M-E Company
29111 Stephenson Highway
Madison Heights, MI 48071

D-M-E Company and D-M-E are registered trademarks of D-M-E Company.

WARRANTY

D-M-E Company warrants that this product will be free from defects in materials and workmanship for a period of three (3) years from the date of shipment. If any such product proves defective during this warranty period, D-M-E Company, at its option, either will repair the defective product without charge for parts and labor, or will provide a replacement in exchange for the defective product.

This warranty shall not apply to any defect, failure or damage caused by improper use or improper or inadequate maintenance and care. D-M-E Company shall not be obligated to furnish service under this warranty a) to repair damage resulting from attempts by personnel other than D-M-E Company representatives to repair or service the product; b) to repair damage resulting from improper use or connection to incompatible equipment; or c) to service a product that has been modified or integrated with other products when the effect of such modification or integration increases the time or difficulty of servicing the product.

VCTB-4000

Four Zone, 24 Volt DC Valve Gate Controller

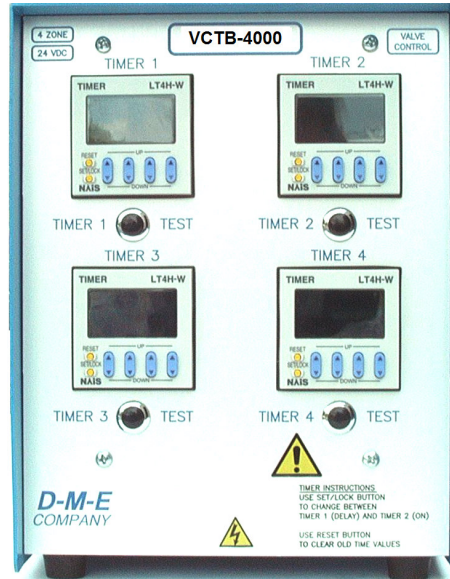

GENERAL DESCRIPTION

This manual describes the installation, operation and servicing of the Valve Gate Controller.

The VCTB-4000 Valve Gate Controller is designed to provide time based control of up to four 24 volt DC valves used to actuate pneumatic valve gate cylinders. It can also be used to operate some hydraulic valves. The VCTB-4000 is small in size so that it is extremely portable and requires minimal counter space.

The Controller uses DIN style solid state timers to provide long life and high reliability. Each timer is capable of dual time functions so that each zone can be programmed with a delay time (timer 1) and an on time (timer 2). The timers in turn drive larger solid state relays that are individually fused against faults.

The Controller is designed to operate from a wide supply of operating voltages (88 to 264 Volts AC) so that this one device can be

used with almost any available power source. This also makes it easier to relocate the controller between different plants or even different countries. The standard product offering comes with a 125 volt AC plug (North American Standard). This plug may be removed and replaced with any number of 240 VAC plugs. Units may also be custom ordered with other plugs, as required.

A single DB-025 cable connects the controller to up to four remotely located valves minimizing required wiring and air connections, thereby making the molding environment neater.

DME offers valve and manifold systems that accept the DB-025 cable directly. For other systems that have independent valve connections, breakout boxes are available that accept the DB-025 connector and provide a terminal strip for individual valve connections.

Test buttons are available for each zone to assist in determining the correct hookup of each of the valves.

UNPACKING AND INSPECTION

After unpacking, inspect your controller and check for any damage that may have occurred during shipment.

Check for proper operation of power switch by turning the switch on and off with no voltage applied.

Check all electrical connectors for visual damage.

If any damaged is observed, return the controller to D-M-E for repair or replacement.

INSTALLATION

You are installing a piece of electronic equipment, which should not be subjected to any physical or environmental abuse. Select a cool, dry, well-ventilated, environmentally clean location, away from heat, moisture and liquid carrying lines, i.e.: water cooling hoses, hydraulic hoses, etc.

Connection of Trigger Signal

Using the cable supplied with the controller, connect the controller to the injection molding machine. The best way to accomplish this is to supply a *dry contact (relay) closure* that is triggered by the injection forward signal of the molding machine. A solid state relay contact can be also be used. It should source power from contact A to contact C.

Alternatively, a limit switch that is operated from mold closure can be used as the trigger signal. The limit switch can be mounted to the tie bar to catch the closing of the moving half of the mold. It may also be mounted to the mold to detect contact of the mold halves.

Contact B of the connector supplies a ground signal to provide shielding of the cable assembly.

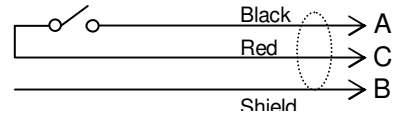

Trigger Signal Connection

Connection of Controller to Valves

Use an appropriate length DB-025 cable with a male connector on one and a female on the other to connect from the controller to the valves. The cable must have conductors with a minimum size of 20 gauge to run *hydraulic* valves.

Conductor numbers 1, 2, 3 and 4 supply +24 VDC power to valves 1, 2, 3 and 4, respectively. Conductor 13 supplies ground to all of the valves.

Connection of AC Power to Controller

The standard offering of the controller is provided with a 120 VAC connector. The controller is designed to run from any voltage between 88 VAC and 264 VAC. Connect the brown conductor of the power cable to L1 (or hot), the blue conductor to L2 (or neutral) and the green conductor with the yellow stripe to ground. *Do not operate the controller without the ground conductor connected.*

NOTE: ALL NATIONAL AND LOCAL ELECTRICAL CODES MUST BE FOLLOWED WHEN CONNECTING THIS EQUIPMENT.

OPERATION

Timer Setup

Do not perform this step until all electrical connections are performed.

Turn controller power on. The timer displays should illuminate. If they do not illuminate, see the Maintenance and Repair sections below.

Each timer unit has two internal timers. Timer 1 sets the delay between when the trigger signal is received and the valve is to open. This is referred to as the "delay"

timer. Timer 2 sets the duration the valve is open. This is referred to as the “on” timer.

Use the SET/LOCK button on the front of the timer to select between the delay timer (Timer 1) and the on timer (Timer 2). The Timer unit front panel will display which timer is selected. (See page 8)

Use the up and down arrow buttons below the display to set the desired time value. Each time value can be set to any value between 00.00 seconds to 99.99 seconds. To set any valve to open immediately, set the delay timer (Timer 1) value to 00.00 seconds.

If the sum of the delay and the on timer is set to a value larger than the time the trigger signal is active, internal electronics will automatically reset the timers at the end of the trigger signal.

When triggered, “Timer 1” (delay timer) of each of the timers will be displayed. The timer will count down until it reaches zero. When Timer 1 reaches zero, Timer 2 (on timer) will be displayed and the timer will count down until it reaches zero. If the Timer 1 value is zero, Timer 2 will be displayed when the trigger signal is displayed, Timer 1 will not be displayed.

Proper setting of each of the “on” timers is determined by part weight or size. For most applications, the on timer should run through the injection fill phase and into the pack (and hold, if present) phases of the injection molding machine.

NOTE: The TEST buttons on the front panel do *not* actuate the timers. The buttons bypass the timers and actuate the solid state relays directly.

The test buttons below each of the timers can be used to verify correct connection to the valve gates. **Warning!: verification should be performed with the operator gates closed to prevent injury from hot plastic.**

Verify correct operation of the timers once the trigger signal is applied.

MAINTENANCE AND REPAIR

NOTE: DISCONNECT POWER BEFORE SERVICING. ONLY ELECTRICIANS OR TRAINED SERVICE PERSONNEL SHOULD REMOVE ACCESS PANELS TO SERVICE INTERNAL COMPONENTS.

Timers Do Not Illuminate

Make sure controller is plugged in and that outlet power is on. Some molding machine outlets may not be energized if machine power is off.

If controller is plugged in and outlet has power, check fuses 1 and 2 on top of the controller. See the figure of the top plate. Use only ABC-3 fuses as replacements. (See page 7).

If a single timer does not illuminate, it may require replacement. See timer replacement at the end of this section. The timers are designed to operate for 10 million cycles so they should not require replacement very often.

Timers Illuminate But Don't Run

Check the trigger signal cable and make sure it is connected. If the cable is connected, disconnect the cable from the controller and ensure the molding machine provides a contact closure when expected by checking the signal between pins A and C.

If you can see a contact closure between pins A and C. You can also check for the presence of 24 volts DC between pins A and C of the trigger signal connector on the top of the unit.

Timer(s) Run But Valve(s) Don't Open

Check cable connection(s) between the controller and the valve(s). If cable damage is suspected, replace the cable.

If the valve cable is determined to be good, check the small fuses on top of the internal solid state relays. If any of these fuses are determined to be open, check the affected zone valves and cable connections for short

circuits. Replace defective fuses only after determining that the related valves and connections are in good order. *The controller was designed to run valves with coil powers as high as 31 watts.*

If the fuses on top of the solid state relays are good, it is possible that a solid state relay may require replacement. Replacement fuses and relays are available from DME. See page7.

Timer Replacement

If timer replacement appears to be necessary, we recommend returning the unit to DME or have it serviced by another known qualified service technician. Replacement timers are available from DME. Use part number RPM-0100.

The replacement timer must be setup before installation. A small access plate on the right side of the timer gives access to a bank of small switches. Open the plate. Set all switches except switch number four to "ON". Replace the damaged timer making sure to locate all wires in the proper location. Tighten all unused screws. The provided instructions also give details on correct mounting of the timer.

The first time the unit is powered up, set the timer to "Integrate A" mode by performing the following: (1) Press and hold the SET/LOCK button, (2) Press the right most up or down arrow, (3) Release the SET/LOCK button, (4) Continue pressing the right most up or down arrow until "In-A" is displayed, (5) Press the reset key. The timer is now ready for use.

OUTPUT CURRENT LIMITATIONS

The controller is designed to power four valves with a maximum power requirement of approximately 31 watts each. This is usually sufficient to power hydraulic valves typically used with valve gate controls.

CONNECTORS AND CABLES:

The required power and trigger signal cables are provided with the controller.

RETURN POLICY

The D-M-E® VCTB-4000™ is warranted for 1-year parts and labor, excluding fuses. Contact D-M-E Customer Service for return authorization for repairs, or warranties. Replacement parts are also available through the Customer Service Department.

D-M-E Customer Service

In U.S.: 1-800-626-6653
 In Canada: 1-905-677-6370

SERVICE CENTER U.S.A.

D-M-E WORLD HEADQUARTERS
 29111 STEPHENSON HIGHWAY
 MADISON HEIGHTS, MICHIGAN 48071
 TELEFAX: (248) 398-6174
 D-M-E® is a registered trademark of D-M-E Company.

REPLACEMENT PARTS	
DESCRIPTION	CATALOG NUMBER
Fuse 1 and 2	ABC-3
Solid State Relay Fuses (T5 series, 4 amp, 250 VAC)	RPM-0098
Solid State Relay	RPM-0099
Replacement Timer	RPM-0100
Trigger Cable	RPM-0101

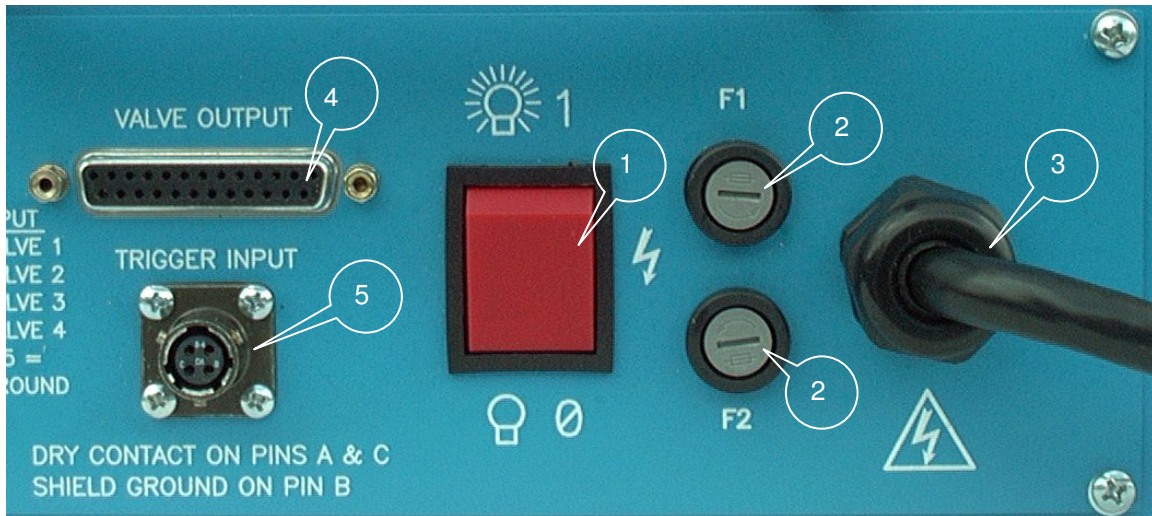

TOP PLATE

1. Power switch
2. Main Fuses: replace with Bussman ABC-3 only!
3. Power Entry Cord
4. Valve Output Connector
5. Trigger Signal Input

NOTE: TRIGGER INPUT #5 (Customer Connection to Trigger signal dry contact – Injection Forward)

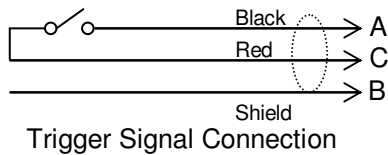

Note: Valve Output Valve # 4 Above

PINS 1, 2, 3 and 4 supply +24 VDC Control power to valves 1, 2, 3 and 4, respectively. PIN 13 supplies ground to all of the valves.

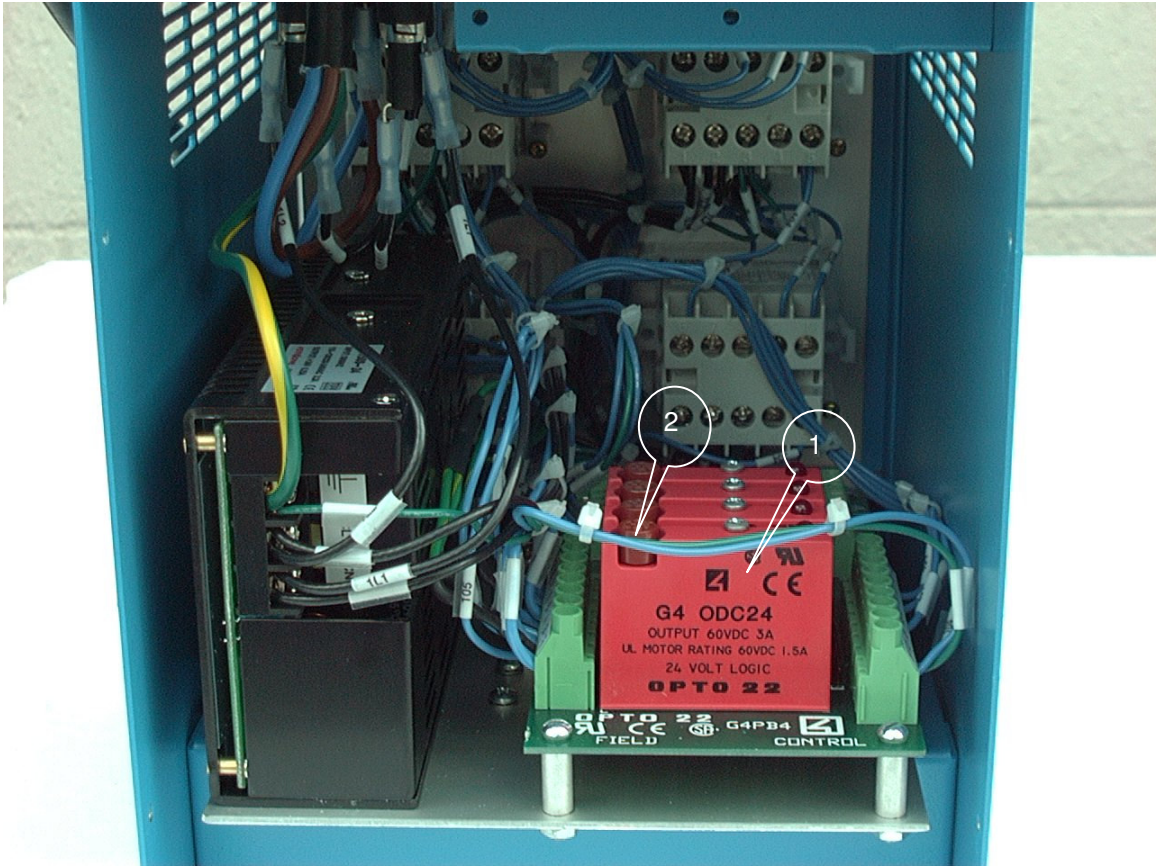

**INSIDE OF UNIT WITH REAR COVER REMOVED
(AS VIEWED FROM REAR OF UNIT)**

1. Solid State Relays (zone 1 closest, zone 4 furthest)
2. Solid State Relay Fuses (replace with T5 series, 4 amp, RPM-0098)

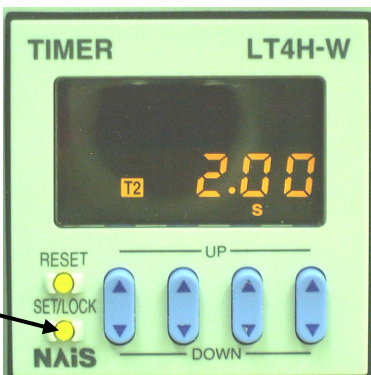

TIMERS

Use SET/LOCK button to change between T1 (delay) and T2 (on) timers. Use up and down arrows to change time values

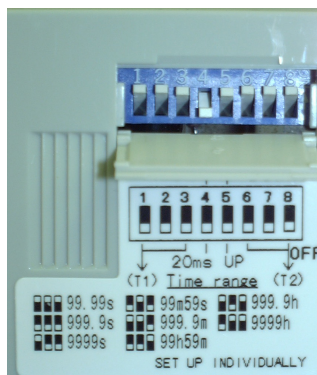

TIMER SETUP

Set all switches except 4 to ON (as shown). Switches are on right side of timer behind a cover plate



TIMER TEST BUTTON

The button below each of the timers can be used to test the associated valve. The button does *not* activate the timer

Instructions Installation Instructions for the
VCTBA-01 Valve Gate Control Interface Accessory



VCTBA01 ACCESSORY: VCTB4000 TO POLIVALVE 2X8 CONNECTOR
(Cable is wired for 8 zones, but only controls 4 zones when connected to the VCTB4000 as shown below)

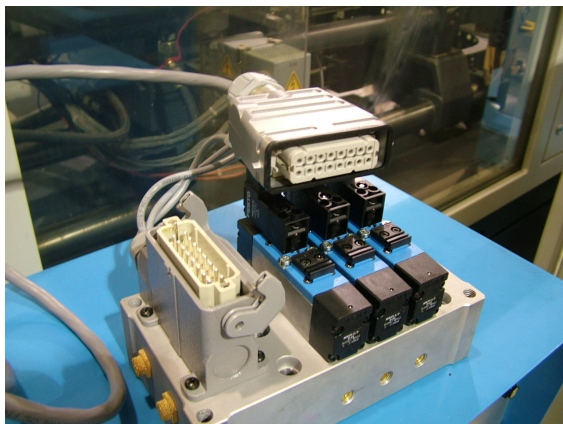

VCTBA01 shown with 2x8 Polyvalve Assembly

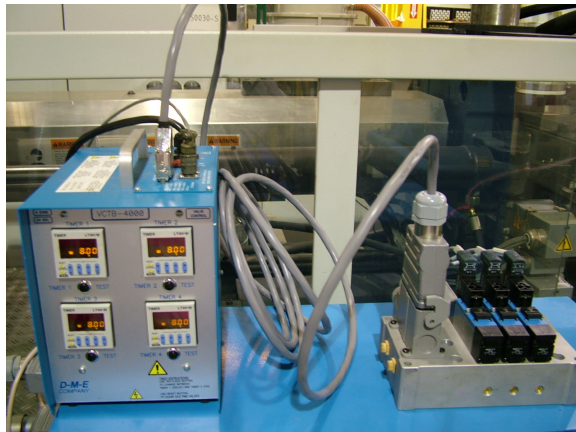

VCTBA01 shown connected to VCTB4000 & Polyvalve Assembly

Installation Instructions for the VCTBA-02 Valve Gate Control Interface Accessory & Support Accessories VCTBA-03, VCTBA-04 & VCTBA-05

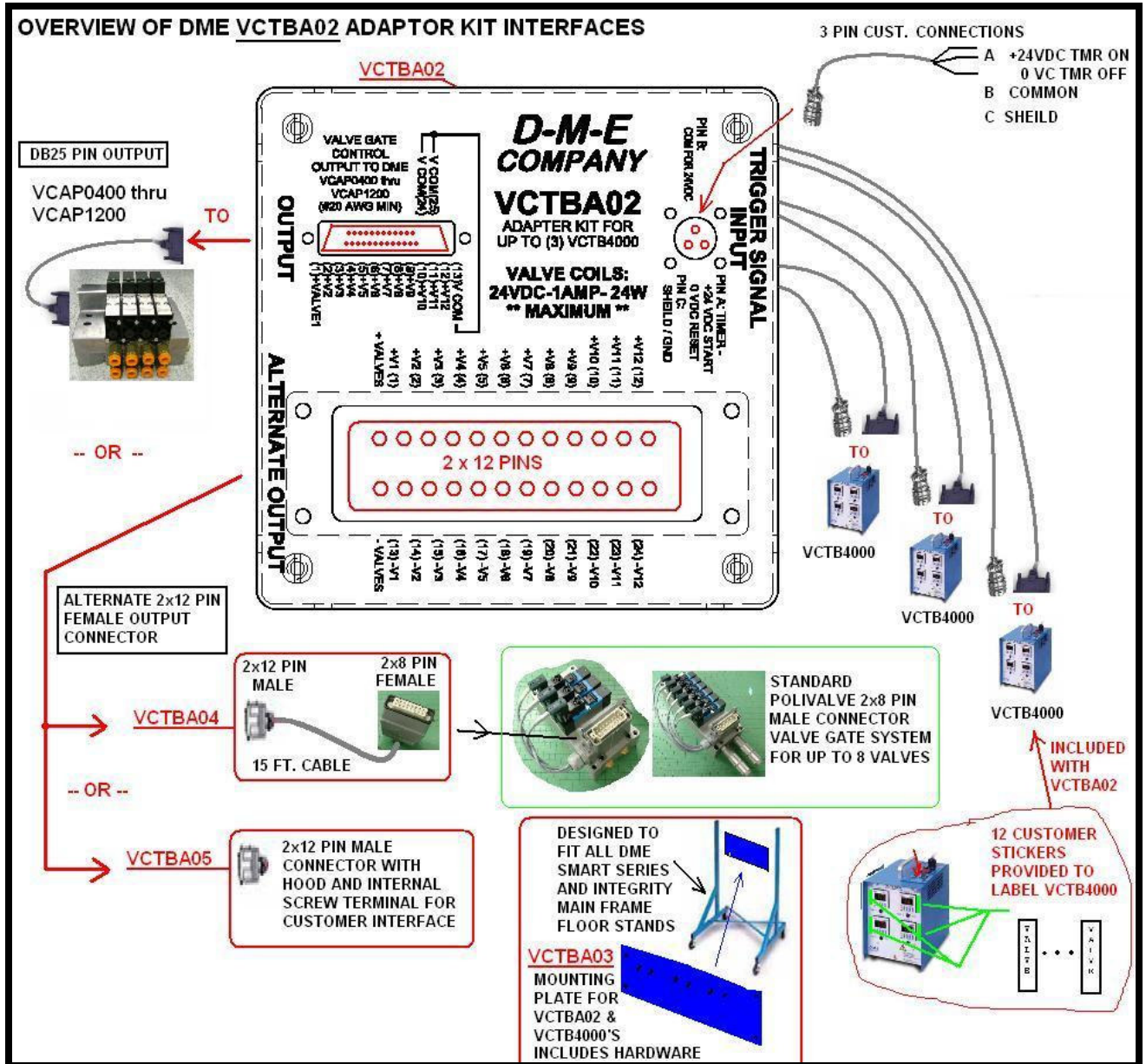

ASSEMBLY INSTRUCTIONS

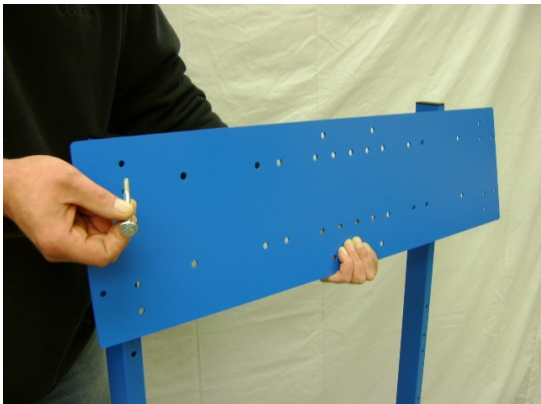

Step 1. Assemble the **VCTBA03 “VCTB-4000 Mounting Plate”** to the mainframe floorstand using the supplied hardware.

The mounting plate is designed to work with either the standard “G” Series @ MFS512G or Integrity @ IFSS1000 or IFSA1000 (with or without the upright extension kit IFSE1000).

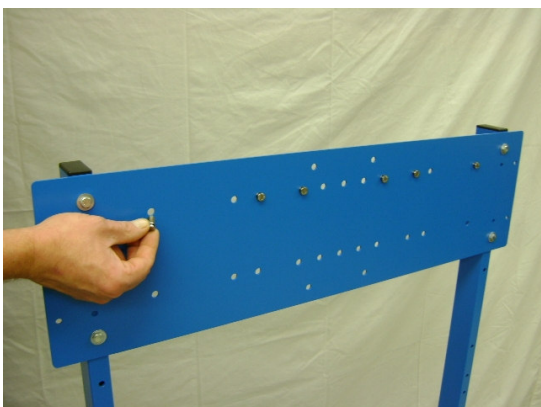

Step 2. Install the VCTB-4000 mounting studs provided with the VCTBA03 mounting plate. The mounting plate can accommodate one, two or three VCTB-4000 controllers.

The photo below illustrates controller positioning.

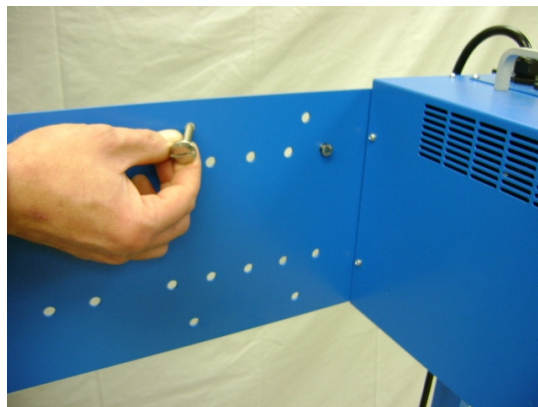
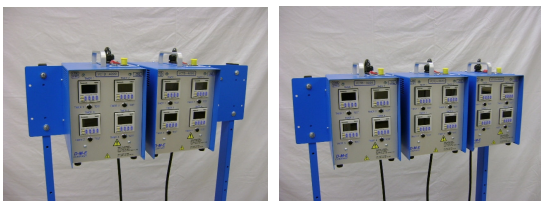

Step 3. The VCTBA02 interface accessory is to be installed on the back side of the mounting plate. Use the (4) large flush head bolts provided in the kit.

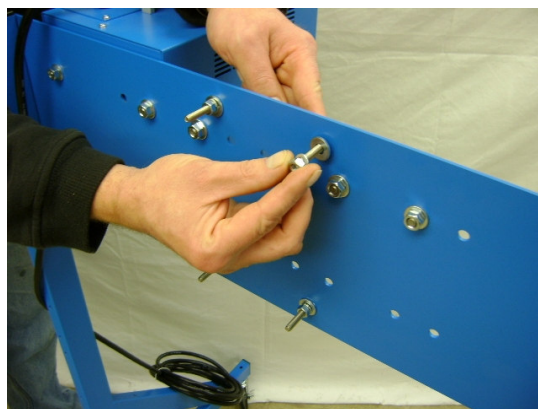

Step 3a. The large flush head bolts should be fastened to the mounting plate using the provided nuts and washers.

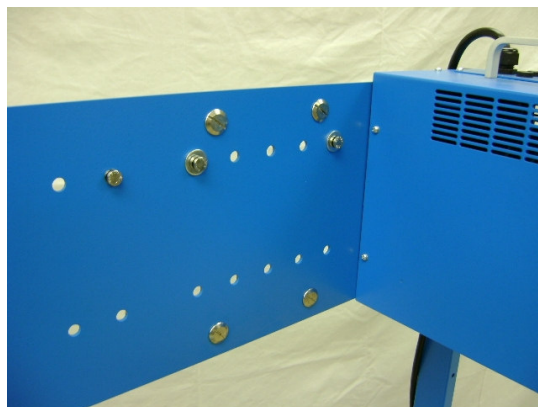

Step 3b. When using the VCTBA02 mounted behind the VCTB-4000 controllers it will be necessary to install the provided flat washers behind the (2) center position VCTB-4000 mounting studs.

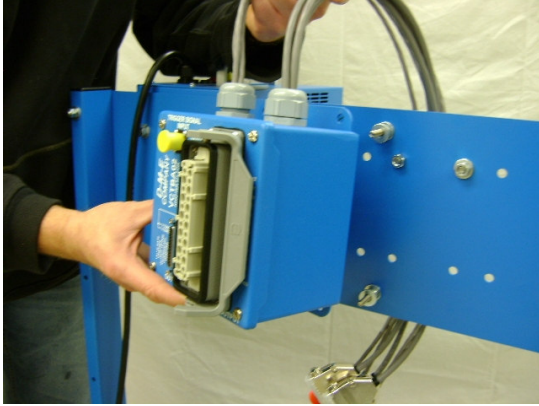

Step 4. Install the **VCTBA02** on the studs installed in step 3 above. Note the direction of the control and trigger cables (in the upward direction).

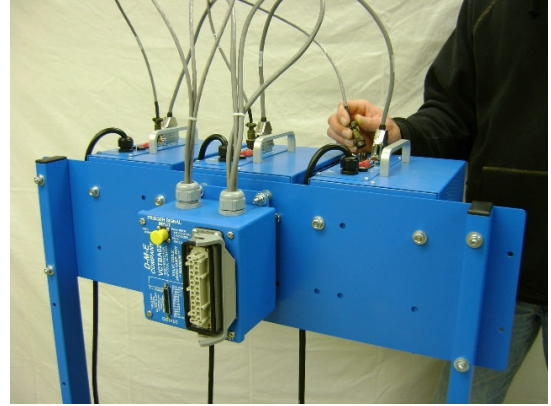

Step 7. Route and connect each of the three VCTBA02 trigger cables to the associated VCTB-4000 controllers. A zone number label identifies the cable ends.



Step 5. Install the supplied zone labels and write the associated valve gate control zone number in the label box with an indelible marker. NOTE that each VCTB-4000 four controllers need to be grouped together. For example, VCTB-4000 #1 will become zones 1-4, VCTB#2 will become zones 5-8, and so on.

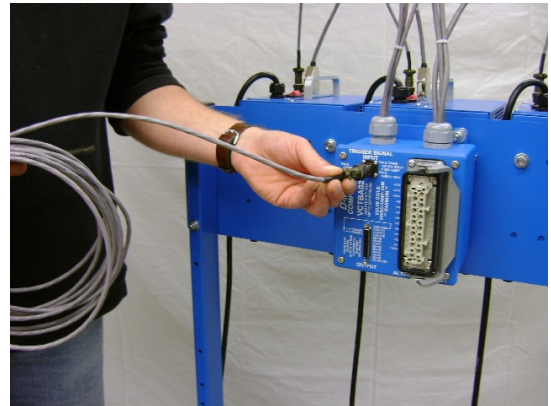

Step 8. Connect the TRIGGER INPUT CABLE of the VCTBA02 to the molding machine +24 VDC injection forward signal.

NOTE THAT THE TRIGGER INPUT OF THE VCTBA02 IS NOT A DRY CONTACT CLOSURE CONNECTION! The VCTBA02 trigger input requires +24 VDC to trigger the connected VCTB-4000 controllers.

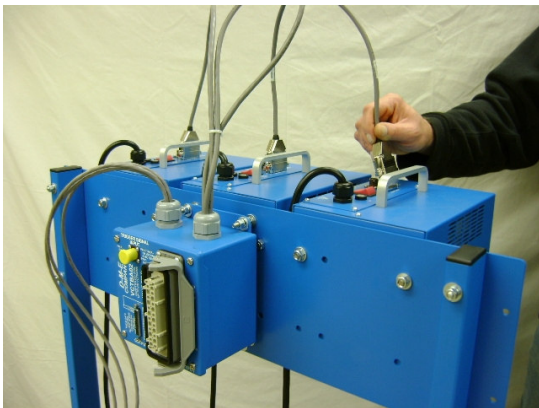

Step 6. Route and connect each four-zone valve control cables of the VCTBA02 to the associated zoned VCTB-4000 controllers. A zone number label identifies the cable ends.

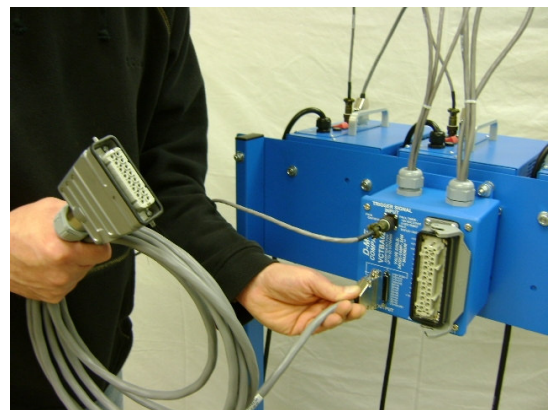

Step 9. Connect the **VCTBA01** eight zone valve control cable to the standard DB-25 output connector of the VCTBA02, and connect to the mold valve gate control input connector.

- OR -

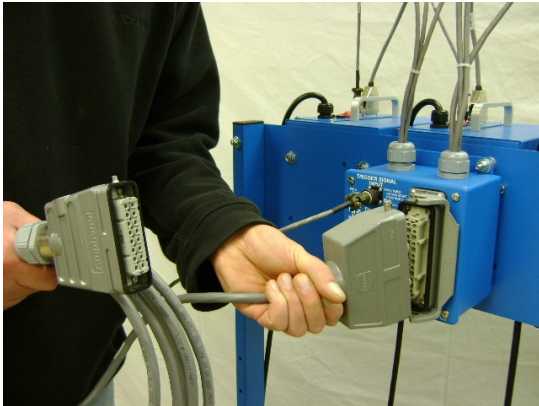

Connect the **VCTB04** eight zone control cable to the "alternate" output connector of the VCTBA02.



P/N: **VCTBA05**

A twelve-zone control cable connection can be made using the twelve-zone accessory output mating cable connector kit VCTBA05.

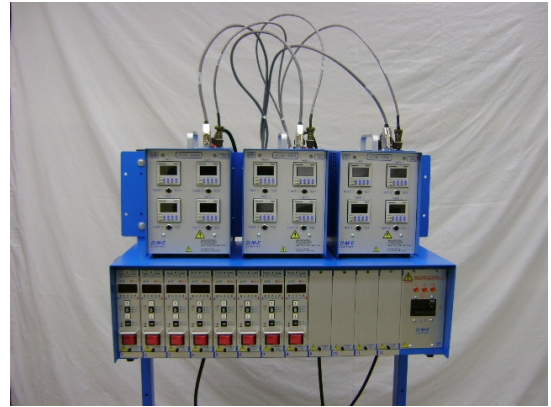

Step 10. Mount the temperature control mainframe to the MFS512G mainframe floorstand.

A standard MFP12G is shown above. To mount a standard MFP8G, use the mainframe adapter plates provided with the MFS512G floorstand kit.



Alternative Mounting: The VCTBA03 mounting plate can also be mounted below the standard mainframe as shown above. To use this mount, the VCTB-4000 mounting studs on the mounting plate must be installed in the lower position. Also, will be necessary to route the VCTBA02 control and trigger cables between the mainframe and mounting plate before either is mounted to the stand.

NOTES:

ECN'S:

- ECN-0622 Changed Model Number from TGV-4000 to VCTB-4000
- ECN-0627 Changed pin out of valve connector
- ECN-0651 Changed warranty period from 1 to 3 years
- ECN-XXXX Preliminary REV E - Added VCTBA-01, VCTBA-02, VCTBA-03, VCTBA-04, VCTBA-05 Assembly Instructions.

APPROVAL:

SENIOR PRODUCT ENGINEER: _____ DATE: _____

MANAGER OF ELECTRONICS: _____ DATE: _____