

VCTB-03-024D-16

One to Sixteen Zone, 24 Volt DC Valve Gate Controller



User Manual

D-M-E Company

SAFETY

D-M-E Company products have been designed to be safe and simple to operate. As with any electronic equipment, you must observe standard safety procedures to protect both yourself and the equipment.

To Prevent Injuries:

- To avoid electrical shock or fire hazard, do not apply voltage to a terminal that exceeds the range specified for that terminal.
- To avoid mechanical injury, electrical shock or fire hazard, do not operate this product with covers or panels removed.
- To avoid electrical shock or fire hazard, do not operate this product when wet.
- To avoid injury or fire hazard, do not operate this product in an explosive atmosphere.
- To avoid burn hazards, do not operate valve gates with operator gates open. Correct hookup of valve gates should only be performed with all operator guards in place.
- To avoid burn hazards and possible damage to equipment, do not leave hot runner systems at elevated temperature for extended periods of time. When the mold and machine are not operating, disconnect the molding machines injection unit from the hot runner system so that pressure may discharge through the sprue or manifold extension nozzle. Make sure the molding machines purge guard is in place.

To Prevent Product Damage:

- Do not operate this product from a power source that applies more than the voltages specified.
- Do not apply any external voltage to the dry contact injection forward input pins. Only a contact closure or solid state relay should be used. Alternately, a +24Vdc signal can be applied to different injection forward pins. Check user manual hookup instructions.
- Only use external solenoids with commutation diodes installed near the coils to prevent damage to the controllers internal solid state relays.

DME RIGHTS

Copyright © D-M-E Company 2012. All rights reserved.

D-M-E Company products are covered by USA and foreign patents, issued and pending. Information in this publication supersedes that in all previously published material. Specifications and any changes are reserved.

Printed in the United States of America

D-M-E Company
29111 Stephenson Highway
Madison Heights, MI 48071

D-M-E Company and D-M-E are registered trademarks of D-M-E Company.

WARRANTY

D-M-E Company warrants that this product will be free from defects in materials and workmanship for a period of 90 days from the date of shipment. If any such product proves defective during this warranty period, D-M-E Company, at its option, either will repair the defective product without charge for parts and labor, or will provide a replacement in exchange for the defective product.

This warranty shall not apply to any defect, failure or damage caused by improper use or improper or inadequate maintenance and care. D-M-E Company shall not be obligated to furnish service under this warranty a) to repair damage resulting from attempts by personnel other than D-M-E Company representatives to repair or service the product; b) to repair damage resulting from improper use or connection to incompatible equipment; or c) to service a product that has been modified or integrated with other products when the effect of such modification or integration increases the time or difficulty of servicing the product.

VCTB-03-024D-16

One to Sixteen Zone, 24 Volt DC Valve Gate Controller



1.) GENERAL DESCRIPTION

This manual describes the installation, operation and servicing of the Valve Gate Controller.

The VCTB-03-024D-16 Valve Gate Controller is designed to provide time based control of up to sixteen 24 volt DC solenoid valves with commutation diodes used to actuate pneumatic or hydraulic valve gate cylinders. This controller has the same form factor as the Standard 12 zone DME SmartSeries Hot Runner Controller Mainframe size.

The Controller uses a PLC with programmable timers to provide long life and high reliability. Each timer zone is capable of dual time functions so that each zone can be programmed with a “delay off” time and an “on time”. The timers in turn drive larger solid state relays that are individually fused against faults.

The Controller is designed to operate from a wide supply of operating voltages (115 to 250 Volts AC 50/60 Hz) so that this one device can be used with almost any available power source. This also makes it easier to relocate the controller between different plants or even different countries. The standard product offering comes with a 125 volt AC plug (North American Standard). This plug may be removed and replaced with any number of 240 VAC plugs.

Two DB-025 connectors are provided to remotely connect the Standard DME VCAP Pneumatic Air

Valve Assembly product line, which are sold separately and include their own cables. The First “VCAP OUT 1” DB-25 connector can directly control a standard DME VCAP-0400 (4 zone), VCAP-0600 (6 zone), VCAP-0800 (8 zone), VCAP-1000 (10 zone), or the VCAP-1200 (12 zone). If 16 zones are required, then two VCAP-0800 (8 zone) Air Valve assemblies are used with the first VCAP-0800 attached to the “VCAP OUT 1” DB-25 connector for timer zones 1-8, and the second VCAP-0800 (8 zone) attached to the “VCAP OUT 2” DB-25 connector for zones 9-16. Note that zones 9-12 are duplicated/run in parallel on both DB25 connectors for this purpose. These assemblies minimize required wiring and air connections, thereby making the molding environment neater. These connectors are designed to work only with the low amp current DME VCAP air assembly solenoids which are only 1.2 Watts each.

For other systems that have independent valve connections, two 16 pin connectors with screw terminals labeled “MAIN OUT 1” and “MAIN OUT 2” are provided for customers individual solenoid valve with commutation diode connections for zones 1-8 and 9-16.

Manual Screen Mode Test buttons are available for each zone to assist in determining the correct hookup of each of the valves. See OPERATION, Manual Mode.



Front view.

A Graphical Touch Screen is mounted in the middle of the panel and controls and monitors all Timer Controller functions. Front Panel LED's are illuminated when actual +24 Vdc voltage output is applied to zone 1,2,...16 and are wired in parallel with the associated Timer # 1-16 Zone. An Emergency Stop Switch, Alarm Horn Silence

Switch, and Alarm Horn are mounted on the front also. The power switch on the front applies the single phase 115-250 VAC 50/60 Hz power to the entire system with a neon indicator power light above it.

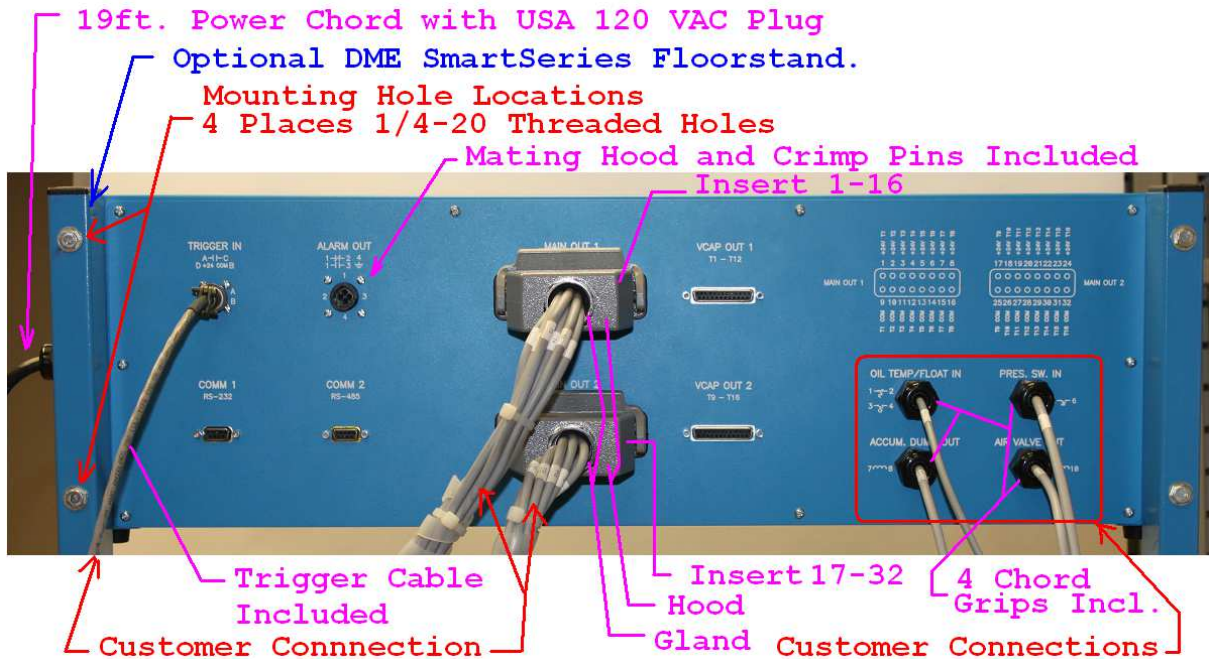

Back View.

Floor stand mounting holes are provided in the outer four corners, – same as MFP12G.

Alarm Output Connector; recommended to be used to stop the next injection forward / Trigger signal if controller is in alarm.

The center of the panel has two pairs of parallel wired output connectors, MAIN OUT 1 and 2, VCAP OUT 1 and 2. The MAIN OUT 1 & 2 are designed to power sixteen valves with a maximum power requirement of approximately 35 watts each. This is usually sufficient to power hydraulic valves typically used with valve gate controls.

Optional alarm inputs and system control outputs.

Two DB9 connectors; one RS232 and one RS485 Communication Port.

2.) UNPACKING AND INSPECTION

After unpacking, inspect your controller and check for any damage that may have occurred during shipment.

Check for proper operation of power switch by turning the switch on and off with no voltage applied.

Check all electrical connectors for visual damage.

If any damaged is observed, return the controller to D-M-E for repair or replacement.

2.1) INSTALLATION

You are installing a piece of electronic equipment, which should not be subjected to any physical or environmental abuse. Select a cool, dry, well-ventilated, environmentally clean location, away from heat, moisture and liquid carrying lines, i.e.: water cooling hoses, hydraulic hoses, etc.

2.2) Connection of AC Power to Controller

The standard offering of the controller is provided with a 120 VAC connector. The controller is designed to run from any voltage between 115 VAC and 255 VAC. The supplied 120 VAC cord has 0.25" Quick Disconnect terminals, and are directly connected to two panel mount fuses, and the ground wire is attached to the chassis through a stud, and crimped ring terminal. *Do not operate the controller without the ground conductor connected.*

NOTE: ALL NATIONAL AND LOCAL ELECTRICAL CODES MUST BE FOLLOWED WHEN CONNECTING THIS EQUIPMENT.

2.3) Connection of Trigger Signal

The Trigger Signal input can be applied to the VCTB-03-024D-16 timer controller in two (2) different ways:

1. The +24Vdc Trigger Version allows multiple units to be daisy-chained together with one (1) Trigger Signal.
2. The Dry Contact version requires an isolated dry contact for each timer unit used.

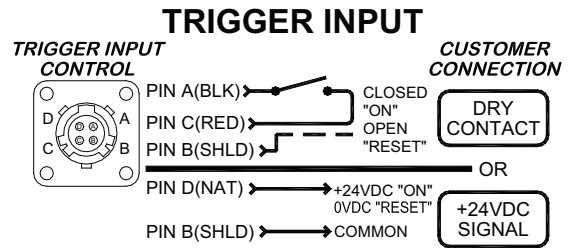

The included 20' cable assembly with mating 4 pin connector, should be used to connect either the dry contact or +24 Vdc trigger signal to the controller. See Trigger Input diagram above.

The best way to accomplish this is to supply the trigger signal that is associated with the injection forward signal. This gives the most repeatable and accurate results. Alternately, a mold closed signal can be used, but is less accurate due to the time between mold closing and injection forward signal starting from the Injection Molding Machine. A limit switch can be mounted to the tie bar to catch the closing of the moving half of the mold. It may also be mounted to the mold to detect contact of the mold halves.

2.4) Connection of Controller to Valves

DME supplies two methods for connections to the controller's 16 Timer Outputs labeled T1 to T16. There is only one timer control per Zone, but are run in parallel to different connectors. Ex. T1 exists on "MAIN OUT 1" and VCAP OUT 1" connectors. (only one T1 Output should be used.)

Method ONE is dedicated to connecting to DME "VCAP" Pneumatic Solenoid Valve Assemblies. It uses the VCAP supplied DB25 type cable which is limited under 3 Watt / 0.125 Amp at 24 Vdc Power requirements due to connector / wire size limitations. Example: T9-T12 overlap on both connectors so that a single VCAP1200 12 zone unit can be driven by a single DB25 Supplied Cable. These overlapping zones cannot be used in this case for the VCAP OUT 2. This also allows two VCAP0800 assemblies to be used on both VCAP OUT 1 for T1-T8 and VCAP OUT 2 for T9-T16 for a 16 Zone capability.

Method TWO is a pair of MAIN OUT 2x8 pin 8 Zone connectors with screw terminations for up to 16 zones. Each zone can drive a solenoid with a commutation diode up to 35 Watts / 1.45 Amp. at +24Vdc maximum. This is the preferred connector method for customer interfacing.

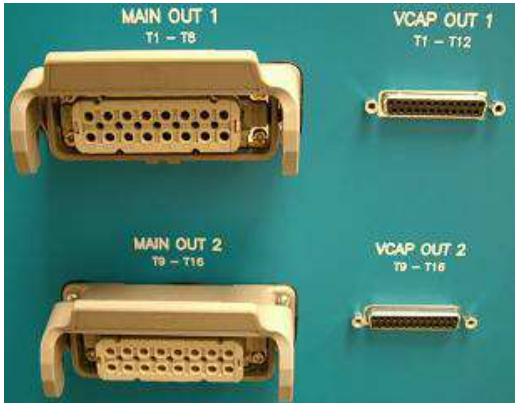

Pair of Supplied "MAIN OUT" connectors which have screw terminals on the white inserts for customer hookup.

2.4.1) **METHOD ONE DETAILS:** Connections to DME VCAPXXXX Pneumatic Valve Assemblies with VCAP supplied Cable. Connections to the "VCAP OUT" connectors on back panel are shown.

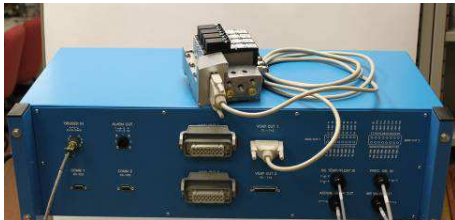

VCAP OUT 1 Pin numbers 1, 2, 3, to pin 12 supply +24 VDC power to valves 1, 2, 3, to Valve 12 respectively. Conductor 13 supplies ground to all of the valves.



VCAP0400 (sold separately with its included cable), shown electrically connected to the VCAP OUT 1 connector of the VCTB-03-024D-16 Controller.

VCAP OUT 2 Pin numbers 1, 2, 3, to pin 8 supply +24 VDC power to valves 9, 10, 11, to Valve 16 respectively. Conductor 13 supplies ground to all of the valves. (Note that zones 9 thru 12 are in parallel with VCAP OUT 1).

This method is only recommended with DME VCAP Air Assembly products, but if connections are necessary with a NON DME VCAP product, then use an appropriate length DB-025 cable with a male connector on one and a female on the other to connect from the controller to the valves. Customer solenoids must have commutation diodes installed near the solenoid coils. The cable must have conductors with a minimum size of 20 gauge to run *hydraulic* valves.

2.4.2) **METHOD TWO DETAILS:** DME Hydraulic Valve System Connections and Customer Connectors.

Typical DME Hydraulic System Assembly integration shown below for a 16 zone system.

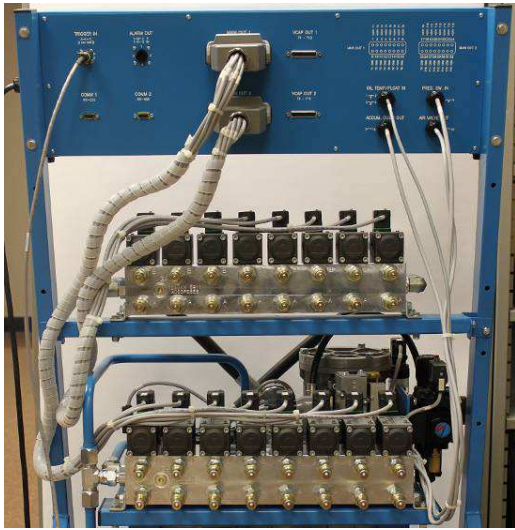

Customer Connectors and wiring information below. (Screw terminals molded in the white inserts for customer wire connections.) Each zone can drive a solenoid with a commutation diode up to 35 Watts / 1.45 Amp. at +24Vdc maximum and customer should size their wiring accordingly and consult their local electrician for Electrical Code and wire sizing.

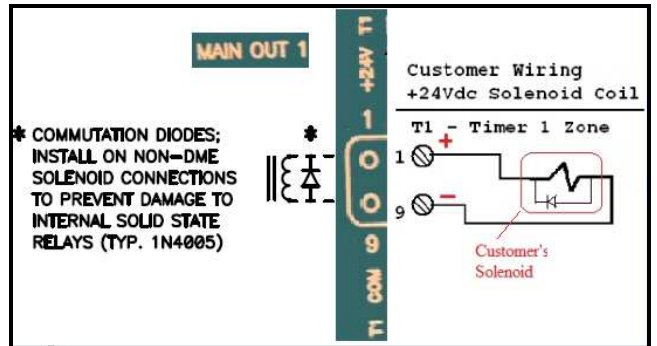
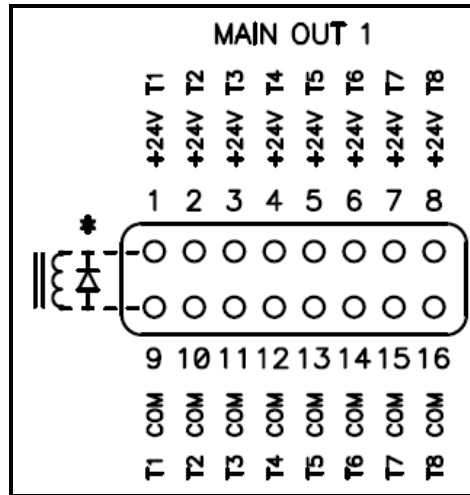

Shows Timer 1 Solenoid Zone Connection Diagram. Shown with typical commutation diode. (diode typically 1N4005). Continue with T2 to T16 in same manner.

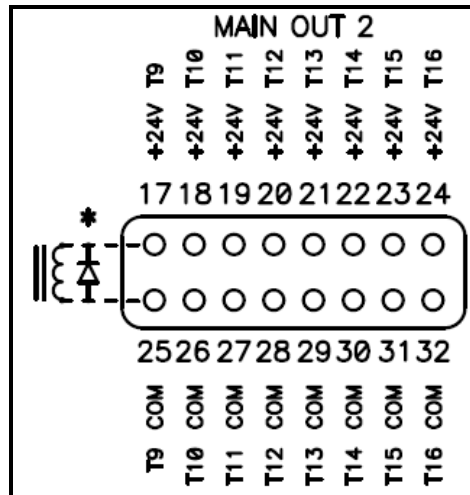

* COMMUTATION DIODES; INSTALL ON NON-DME SOLENOID CONNECTIONS TO PREVENT DAMAGE TO INTERNAL SOLID STATE RELAYS (TYP. 1N4005)

2.5) Alarm Output Connector

This allows a contact closure to be used by customers as needed when the controller has an Alarm Condition. The contacts are shown with POWER ON and NO ALARM CONDITIONS. The contacts will change with a power failure or if an ALARM EXISTS. This is for fail-safe operation. Also see alarm screen ICON.

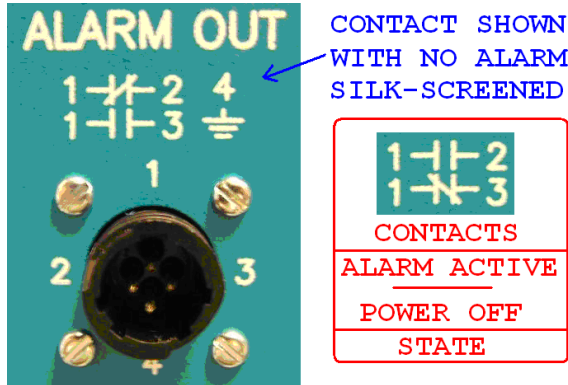

The mating connector parts and crimp pins are supplied for the customer to use.

No Alarm: Closed contact between 1 & 2.
Open Contact between 1 & 3.

Alarm Condition: Open contact between 1 & 2.
Closed contact between 1 & 3.

2.6) Customer Supplied Sensor I/O

These are optionally used inputs and outputs that customers may choose to use with their supplied components. These are shown with the supplied cord grips that customer must remove caps and install with their components and wire to the internal Terminal Strip TB1-1 to TB1-12 position located inside the back removable cover. Power cord must be disconnected before removing the cover to prevent electrical shock.

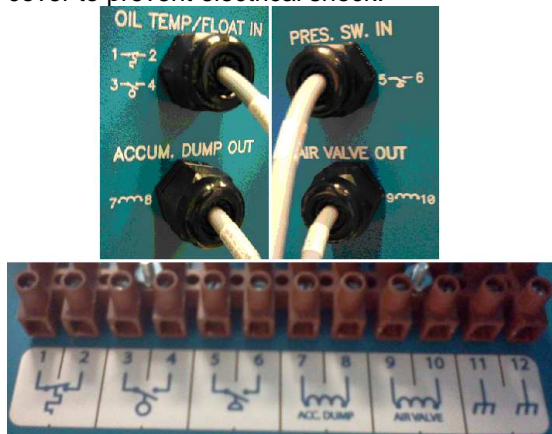

For Pneumatic (Air Pressure) Valve Gate Systems, customer can use an air pressure switch to detect their shop air pressure, and use an Air Valve Out Solenoid Valve with Commutation Diode to power a shop air supply to

their Valve Gates which would only shut off when no power is supplied, or the emergency stop button is activated. Inputs have 5 second delays.

For Hydraulic (Oil Pressure) Valve Gate Systems, customer can use a hydraulic pressure switch, hydraulic oil temperature switch and/or a hydraulic oil level/float switch to cause an alarm condition. Inputs have 5 second delays.

Customer can also use their Air Valve Out Solenoid Valve with a commutation diode +24Vdc signal to activate their hydraulic pumping system, and the Accumulator Dump Valve Solenoid with a commutation diode +24Vdc signal for disabling an accumulator dump valve to remove stored hydraulic pressure when the unit has no power supplied or the emergency stop button is activated.

2.7) Communication Connectors

These are optional used connectors that customer may choose to use. The support documentation is very limited and relies mostly on the PLC manufacturers web site documents for customers to use. DME will only provide basic concepts of how these ports were intended to be used. The customer is responsible for understanding the PLC manufactures information and assumes the risk involved in using these ports. A document will be posted on-line thru DME's Web site at www.dme.net You will have to search the "products and services" tab to find the Control Systems, Valve Gate Products and find the VCTB-03-024D-16 product page. A separate link from this page will allow you to download the communications supplement basic guide.

Main Purpose of this port is to use the PC Software SD Card Suite Unitronics Utility for Managing Recipes on the SD Card.

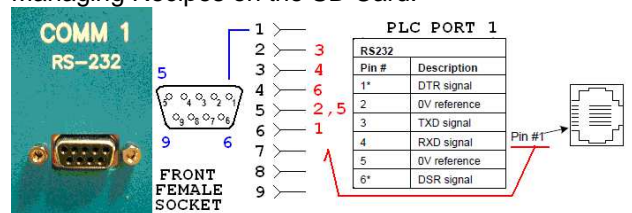

COM 1 – RS232 Port.

The main purpose for this port is for basic RS485 MODBUS communications.

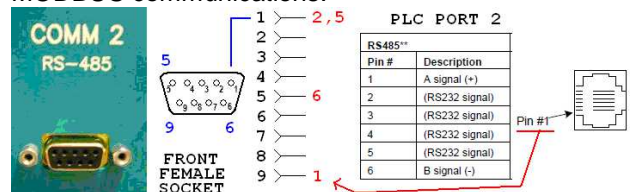

COM 2 – RS485 Port

3.) OPERATION

Timer Setup

Do not perform this step until all electrical connections are performed.

Turn controller power on. The PLC display should illuminate. If it does not illuminate, see the Maintenance and Repair sections below.

3.1) Power Up Screen

After a couple of seconds, the Home Timer Control Screen will appear, stay for a couple seconds, then Automatically switch to the Home Timer Screen.

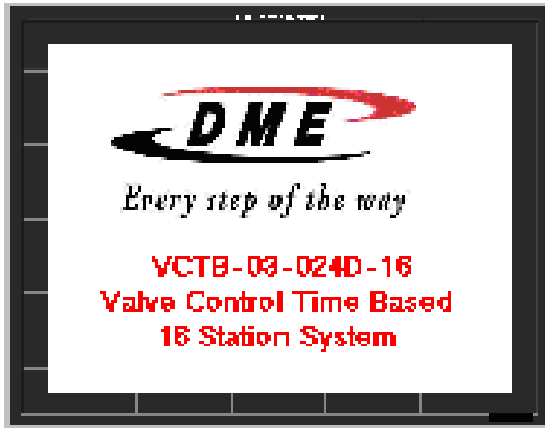

3.2) "Home" Timer Screen

This screen shows the overall status and operating conditions for the entire controller on one screen. The Operator can only use the Vertical Menu Bar on the right, which has seven touch buttons to direct the controller to other Menu Functions.



Operator Vertical Side Menu Bar: The Vertical Menu Bar Function ICONS are described as follows: See the individual Screens after this for more details on each ICON Function. Touching

the ICON will direct the operator to that ICON Function Screen. Each of these Function Screens will have an ICON on their screen in the lower right corner to return to this main Timer Screen. NOTE: The Top Alarm ICON Turns RED when there is an Alarm. It is Blue when there is NO Alarm.

SEE SECTION:	
	Alarm → 3.4) Alarm Screen
	Clock → 3.5) Clock Screen
	Event Log → 3.6) Event Log Screen
	Manual Mode → 3.7) Manual Mode Screen
	Save Recipe → 3.8) Save Recipe Screen
	Load Recipe → 3.9) Load Recipe Screen
	Timer Setups → 3.3) Timer Setup Screen

Once the operator pushes one of the Above ICON's to go to another screen, to return, all other screens have a "Building" or "House" type ICON which returns to this Home Timer Screen.



return "Building" Icon

Top Operator Status Bar: The top of the home timer screen shows the status of the system to the operator as follows”

Recipe Mold ID and Modified Status:

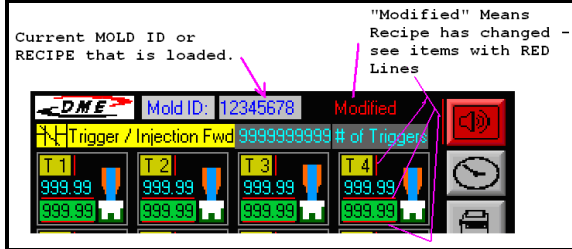

Trigger / Injection Fwd Status Indicators:

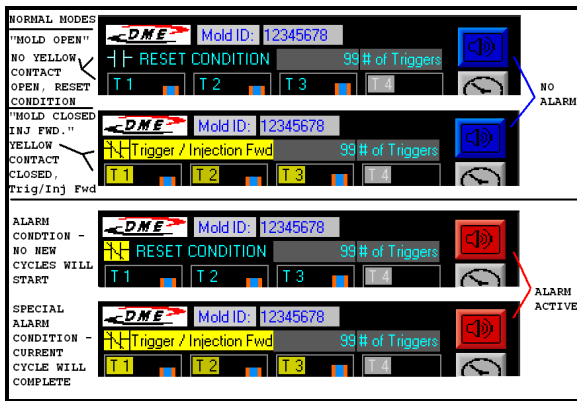

Timer ICON Status Boxes for T1 to T16

Trigger Contact OPEN / RESET CONDITION

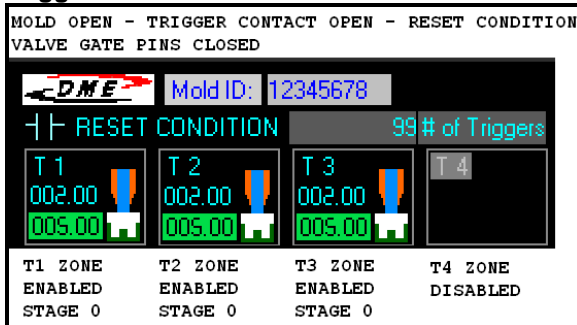

Trigger Contact CLOSED / Trigger / Injection Fwd.

These Stages become active when the unit receives a Trigger / Injection Fwd Closure Signal with NO Alarm Conditions. NOTE the "YELLOW" States of the boxes and the "T1", "T2", etc.

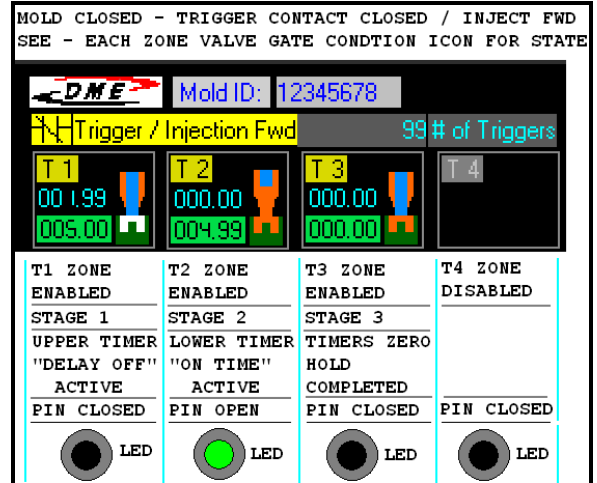

ICONS move from Stage 1 – "Delay Off", to Stage 2 – "ON TIME" PIN OPEN Front Panel LED associated with this Timer Should be Lighted ON / GREEN LED, then remain in Stage 3 until the Trigger is removed / RESET CONDITION. In Stage 1, the Upper Timer "Delay OFF" starts to count down. When it reaches "000.00" then Stage 2 begins and the Lower Timer begins to count down. When it reaches "000.00" then Stage 3 begins which Holds until the Trigger Signal Opens and/or RESET CONDITION occurs and returns to Stage 0.

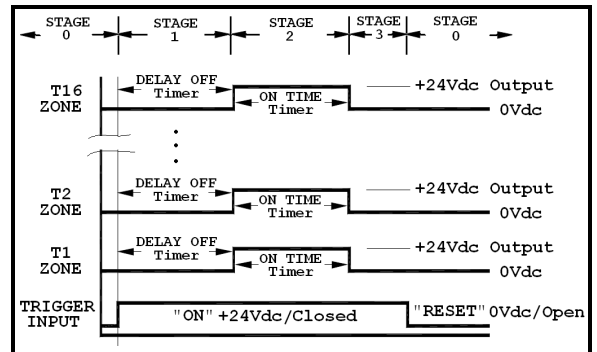

3.3) Timer Setups Screen

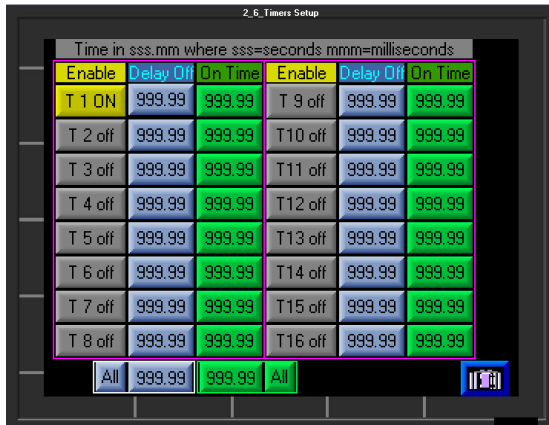

“Building” or “House” type ICON in lower right corner returns to the “Home Timer Screen”.

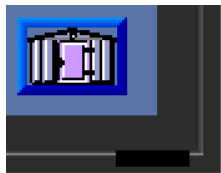

return “Building” Icon

How the Timer Setup Values relate to the “Home Timer Screen”.

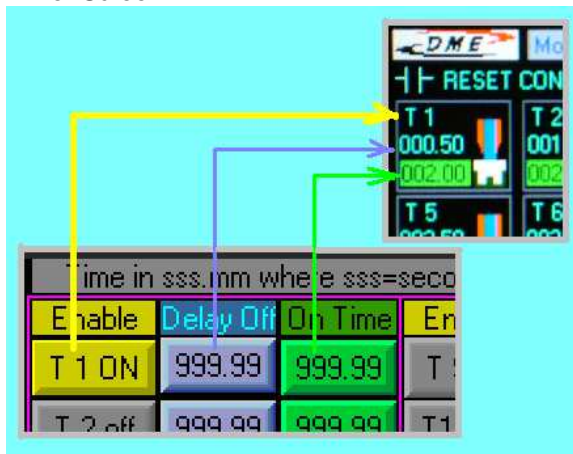

Each timer zone has two timers associated with it. A “Delay Off” and “On Time” Setting. “Delay Off” sets the delay between when the trigger signal is received and the valve is to remain closed (delivers 0 Vdc to Output). When the “Delay Off” times out, then the “On Time” starts and for the duration of this time the valve is open (+24Vd Applied to the Output). When the “On Time” times out, the Zone then switches the valve closed (delivers 0 Vdc to the Output) until the next Trigger/Injection Forward Signal is received. If for any reason the Trigger Signal is lost/open contact, then the Timers will reset and the Valves will

close. If the Trigger Signal is active and an ALARM condition occurs, the current cycle will complete and HOLD until the Trigger Signal becomes inactive, and sends the unit into the RESET condition.

Setting Enable/Disable Timer Zones: Each Timer Zone can be Enabled “T1 ON” in Yellow or Disabled “T1 off” Grayed out by pressing the touch screen over the function for the zone you want to setup. If the Timer is “T1 off” then the zone will NOT cycle and the output for that zone will remain 0 Vdc. This is how you can configure this controller for 1 to 16 zones by enabling just the zones you want to use.

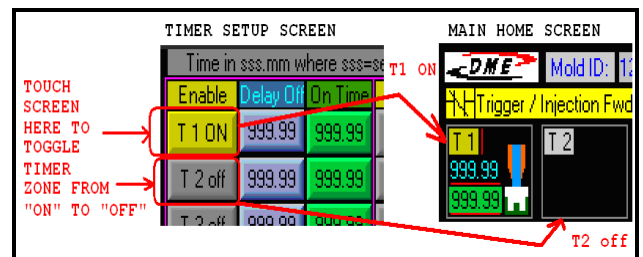

Setting “Delay Off” Value:

Each timer can be set to any value between 000.00 seconds to 999.99 seconds. To set any valve to open immediately, set the Delay Off value to 000.00 seconds.

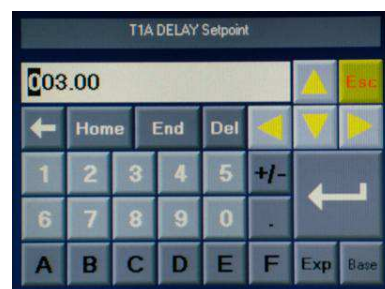



Press Arrow Entry Key to Change or "Esc" to Cancel.

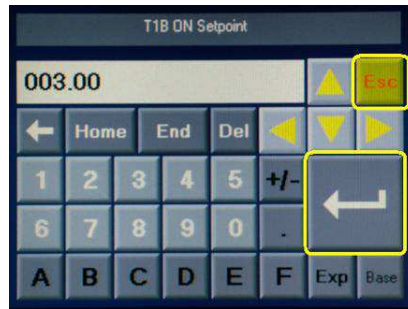

Press Arrow Entry Key to Change or "Esc" to Cancel.

Time in sss.mmm where sss=seconds, mmm=milliseconds

Enable	Delay Off	On Time	Enable	Delay Off	On Time
T 1 ON	004.00	002.00	T 9 off	003.00	002.00
T 2 ON	003.00	002.00	T 10 off	003.00	002.00
T 3 ON	001.00	002.00	T 11 off	003.00	002.00
T 4 ON	003.00	002.00	T 12 off	003.00	002.00
T 5 ON	003.00	002.00	T 13 off	003.00	002.00
T 6 ON	003.00	002.00	T 14 off	003.00	002.00
T 7 ON	003.00	002.00	T 15 off	003.00	002.00
T 8 ON	003.00	002.00	T 16 off	003.00	002.00

At 6.00 7.00 All

Time in sss.mmm where sss=seconds, mmm=milliseconds

Enable	Delay Off	On Time	Enable	Delay Off	On Time
T 1 ON	004.00	003.00	T 9 off	003.00	002.00
T 2 ON	003.00	002.00	T 10 off	003.00	002.00
T 3 ON	001.00	002.00	T 11 off	003.00	002.00
T 4 ON	003.00	002.00	T 12 off	003.00	002.00
T 5 ON	003.00	002.00	T 13 off	003.00	002.00
T 6 ON	003.00	002.00	T 14 off	003.00	002.00
T 7 ON	003.00	002.00	T 15 off	003.00	002.00
T 8 ON	003.00	002.00	T 16 off	003.00	002.00

At 6.00 7.00 All

Setting "On Time" Value:

This time is the value that the Valve Gate Pin will remain OPEN or +24Vdc is Applied to the Output.

Time in sss.mmm where sss=seconds, mmm=milliseconds

Enable	Delay Off	On Time	Enable	Delay Off	On Time
T 1 ON	003.00	002.00	T 9 off	003.00	002.00
T 2 ON	003.00	002.00	T 10 off	003.00	002.00
T 3 ON	001.00	002.00	T 11 off	003.00	002.00
T 4 ON	003.00	002.00	T 12 off	003.00	002.00
T 5 ON	003.00	002.00	T 13 off	003.00	002.00
T 6 ON	003.00	002.00	T 14 off	003.00	002.00
T 7 ON	003.00	002.00	T 15 off	003.00	002.00
T 8 ON	003.00	002.00	T 16 off	003.00	002.00

At 6.00 7.00 All

Some Timer Setting Considerations:

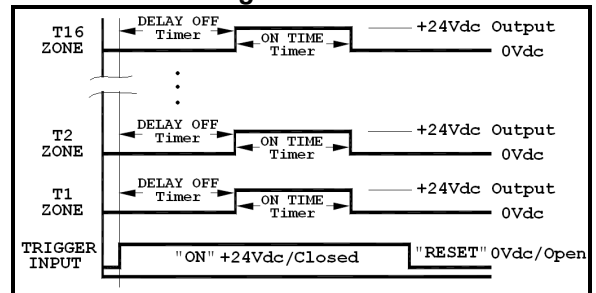

If a timer zone's sum of its "Delay Off" and "On Time" is set to a value larger than the time the trigger signal is active, the PLC will automatically reset the timers at the end of the trigger signal.

When triggered, "Delay Off" timer of each of the zones will become active. The "Delay Off" timer value will count down until it reaches zero. When the "Delay Off" timer reaches zero, the "On Time" Timer will be activated and the timer will count down until it reaches zero. If the "Delay Off" timer value is zero, "On Time" timer will immediately become active and start to count down.

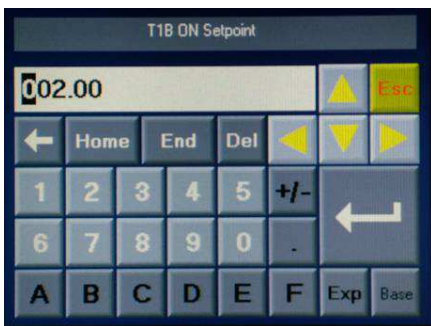

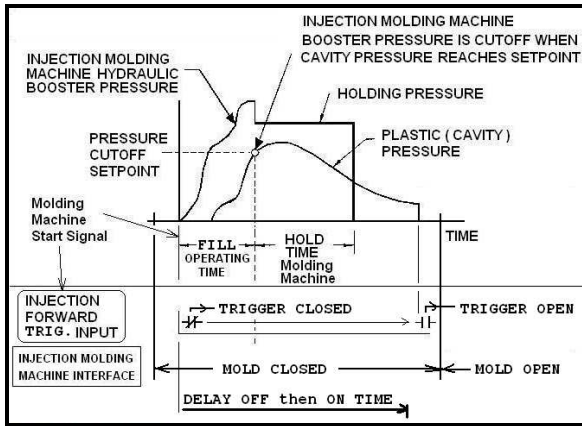

Proper setting of each of the “On Time” values is determined by part weight or size. For most applications, the “On Time” should run through the injection fill phase and into the pack (and hold, if present) phases of the injection molding machine.

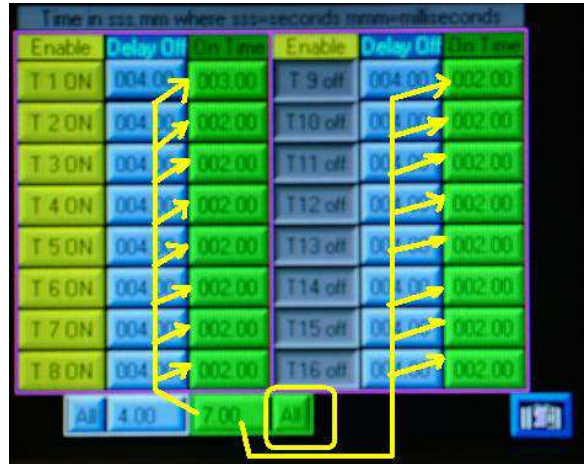

Setting All “Delay Off” Value:

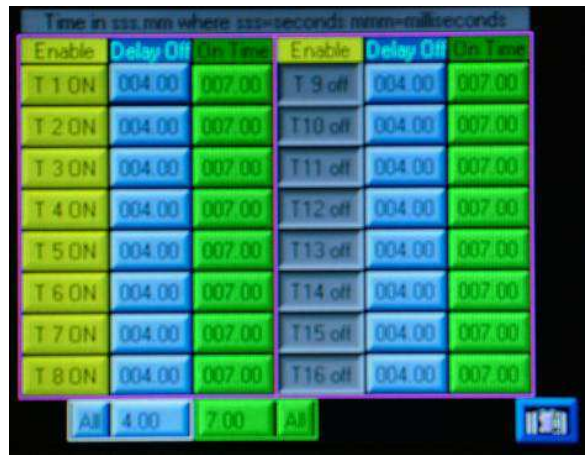
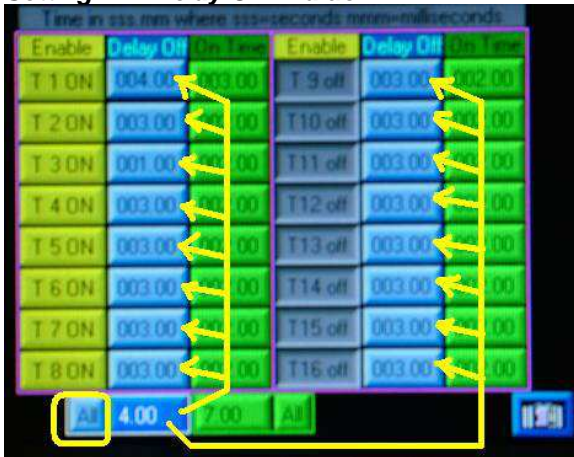

Setting All “On Time” Value:

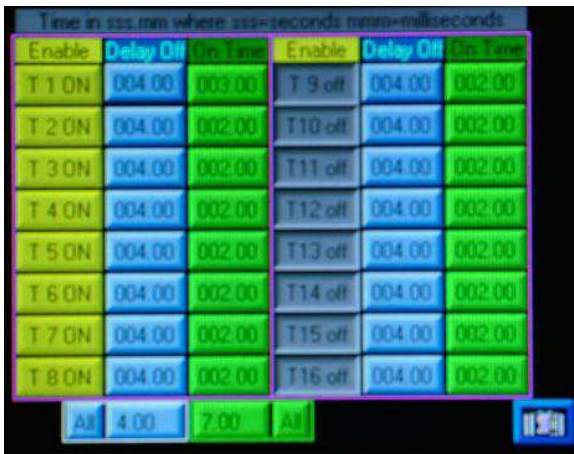

3.4) Alarm Screen and Cycle Resets

This screen has 6 Operator Touch Areas. The lower right “Building” Icon returns to the Home Timer Screen. The two lower left “Reset” Icons reset the system cycle counters. The Yellow/Manual for resetting the Manual Screen Mode Cycles and the Grey/Trigger for resetting the # of Triggers displayed on the Home Timer Screen. The System Counter keeps track of all cycles and cannot be reset. The three “Over-ride Inputs” ON/OFF Yellow/Grey colored ICONS toggle when pushed. They bypass the optional physically wired Inputs as shown. LS1 level switch input is used in hydraulic systems for the oil level in the tank. TS1 switch input is used in hydraulic systems for the oil temperature in the tank. PS1 switch input is the system pressure which can be used to monitor Pneumatic pressure or Hydraulic pressure.

Normal Running State: Emergency Stop NOT pressed – shown Yellow, Inputs are over-riden to make a path to energize “System OK” coil, which controls the Alarm Output Contact Window which directly relate to the Alarm Output connector on the back of the unit.

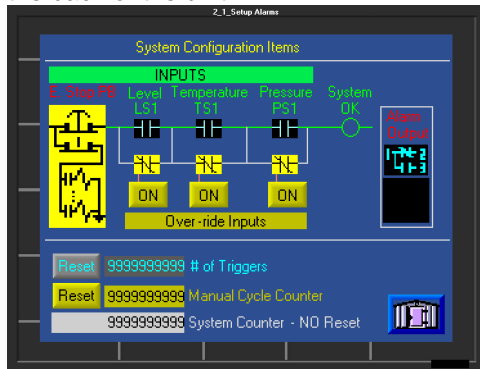

Upper Corner of Home Timer Screen



BLUE ALARM

Warning Running State: An Input is causing an Alarm Condition that can, or is serious. The system will notify operator thru Alarm Horn and Contact Closure. You should immediately determine if the process should be shut down. Note the RED state of the Alarm contacts has changed and the Alarm Horn is “YELLOW” for warning.

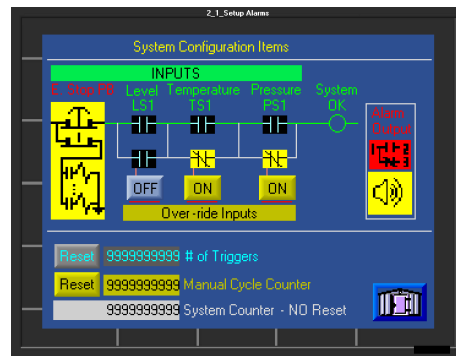

The example shown would be the oil level getting low, but the system would still be able to complete the cycle it was running, then STOP until operator fills more oil in reservoir. It would be worse to stop the Valves in this case if the machine is still running automatic parts. The contact closure should be used to stop the Injection Molding Machine and prevent a new trigger signal from occurring. The operator could Over-ride the input if they felt the system could safely run until the maintenance is performed.

Upper Corner of Home Timer Screen



RED ALARM

Emergency Stop Button Pressed: An operator pressed the Front Panel RED Emergency Stop button which causes an alarm and removes +24Vdc from the Solenoid Output circuits. This also removes power from the optional “Accumulator Dump Valve” and “Air Valve Out” to remove the source of pressure from the system valves if implemented.

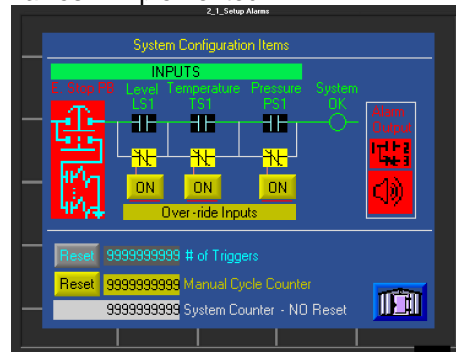

The Emergency Stop switch can be reset by twisting the button about a ¼ turn until it “pops out”. The RED status shown above with input states should return to “Normal Running State”.

Upper Corner of Home Timer Screen



RED - ALARM

3.5) Clock Screen

The Time and Date are Battery Backed Up and are used for recipe file dates and status logged events. Pressing the Lower Right "Building" ICON will return you to the "Home Timer Screen".



Press the Date Button to Adjust the Month/Day/Year as MM/DD/YY

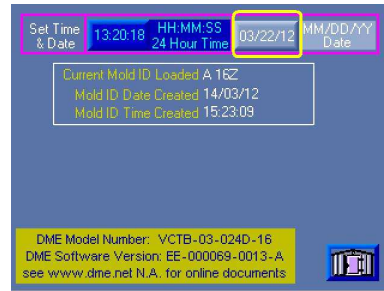

Press the Large Square Arrow Button when Done or Press the "Esc" button to cancel.

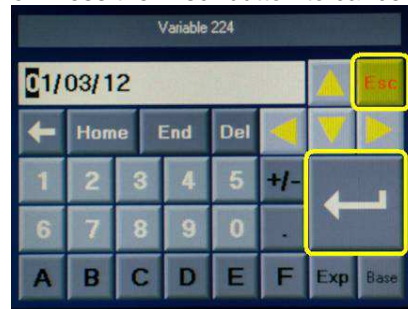

Press the Time Button to Adjust Hours:Minutes:Seconds as HH:MM:SS in 24 Hour Format.

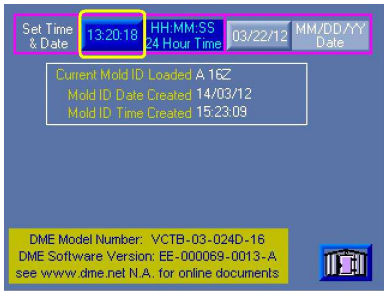

Press the Large Square Arrow Button when Done or Press the "Esc" button to cancel.

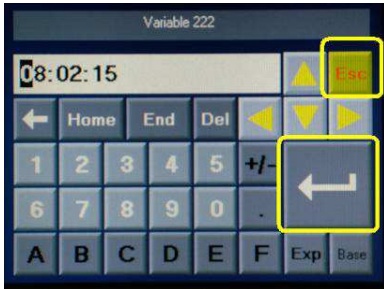

3.6) Event Log Screen

The Event Log Screen keeps an Event Log for the past 200 events then wraps around in a circular log over-writing itself. It helps track what happened when an operator changes something while running. It stores the values so if power is lost, the last 200 Events will still appear. It was not intended to keep a day by day record per a specific date, but is a diagnostic tool to help track recent changes to the process.



3.6.1 Column Data Descriptions

d:hh:mm column:

d: day from 1 to 99
 hh: hour in 24 hour format
 mm: minute

Mold ID column:

This value shows the configuration/recipe name that was last loaded and running.

Trigger # column:

The number of Triggers that have run when the event occurred. This is a sequential number that shows up on the top of the Home Timer Screen.

Event column:

This is an indication/description of what the operator did or main event that occurred.

New column:

This is the new value that was changed.

Old column:

This was the previous value that was replaced.

Orig column:

This was the value loaded from the original recipe.

3.6.2 Event Tag Descriptions

A Timer Delay Setpoint was Changed:

T 1 Dly, T 2 Dly, T 3 Dly, T 4 Dly, T 5 Dly, T 6, Dly, T 7 Dly, T 8 Dly, T 9 Dly, T10 Dly, T11 Dly, T12 Dly, T13 Dly, T14 Dly, T15 Dly, T16 Dly

A Timer ON Setpoint was Changed:

T 1 ON, T 2 ON, T 3 ON, T4 ON, T 5 ON, T6 ON, T7 ON, T8 ON, T9 ON, T10 ON, T11 ON, T12 ON, T13 ON, T14 ON, T15 ON, T16 ON

A Timer Zone Enable Status was Changed:

T 1A-EN, T 2A-EN, T 3A-EN, T 4A-EN, T 5A-EN, T 6A-EN, T 7A-EN, T 8A-EN, T 9A-EN, T10A-EN, T11A-EN, T12A-EN, T13A-EN, T14A-EN, T15A-EN, T16A-EN

A Manual Mode Timer Enable Status was Changed:

T 1 M-en, T 2 M-en, T 3 M-en, T 4 M-en, T 5 M-en, T 6 M-en, T 7 M-en, T 8 M-en, T 9 M-en, T10 M-en, T11 M-en, T12 M-en, T13 M-en, T14 M-en, T15 M-en, T16 M-en

Manual Timer ON or OFF Value was Changed:

T Man ON, T Mn Off,

The Timer All Delay or All ON Value was Changed:

T All Dly, T All On

Input I/O Value Changed:

IN Level, IN Temp, IN Press, Em Stop

System Powered Up or Alarm Activated:

PowerUp, ALARM

Automatic Triggers or Manual Cycle Counter Reset:

Trigs, # Man Cy

Time or Date was Reset:

Time Rst, Date Rst

Manual Operator Mark Log Placed:

- Mark -

Manual Loop Cycles or Single Shot Manual Set:

Man Cyc, 1 ManCyc

Recipe was Saved or Loaded:

SAVE ID, LOAD ID

3.6.3 - Mark – Button Description

Pressing the Lower Right Corner Yellow – Mark – button puts a sequential Operator Placed – Mark – note in the Event Tag field, and the NEW, Old and Orig all show the same number which is a counter for how many times the Mark button was pushed. This aids to help mark a log file and scroll thru the file and find this place again. This counter value is reset to start at 1 on a power down.

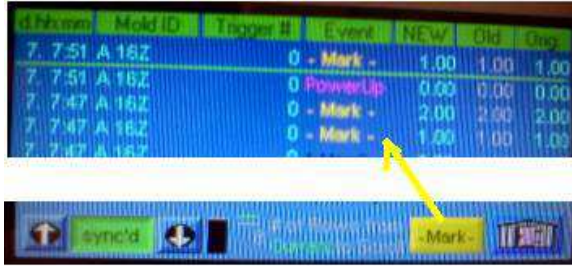

3.6.4 “sync’d” or “scroll” Button Description



When the Green “sync’d” text appears in the lower left display, then the logged values are in sequential order from the most current event in the top of the list to the bottom of the list. The Top 8 Logged Items are FIXED with the most current values. The bottom 4 Values when “sync’d” are the next most current values.

When the Grey “scroll” text appears in the lower left display, then the lower 4 logged values are located somewhere in the circular log buffer that has up to 200 items logged into it. The upper 8 logged events are still the most current.

3.6.5 # of Rows from Current to Scroll Status

Remember that this function is to help diagnose process problems as they occur and are not meant for long term record storage.

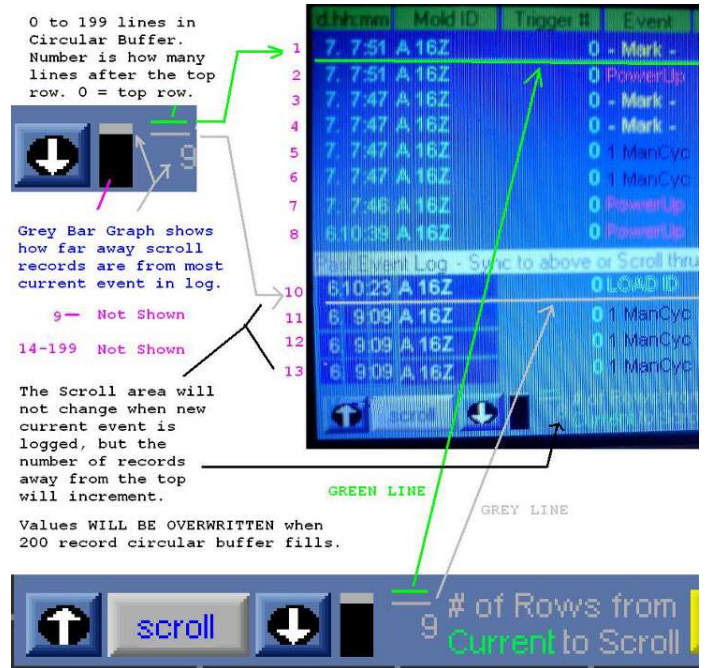

3.7) Manual Mode

NOTE: The "Push and Hold to Turn All Enabled Timer Outputs ON" button on this screen does not actuate the timers. This button bypasses the timers, and actuate the solid state relays directly related to the Manual Timer Output Zones that are ENABLED. This screen does NOT disable the unit from running with incoming trigger signals, but will allow the user to Manually turn one or more zones on thru a Manual Push or a Manual Cycle Timer as described on this page.

This test button and the Individual Manual Timer Output Enable buttons can be used to verify correct connection to the valve gates.

Warning!: verification should be performed with the operator gates closed to prevent injury from hot plastic.

Verify correct operation of the timers once the Setup is completed/saved/loaded and the trigger signal is applied on your "HOME Timer Screen".

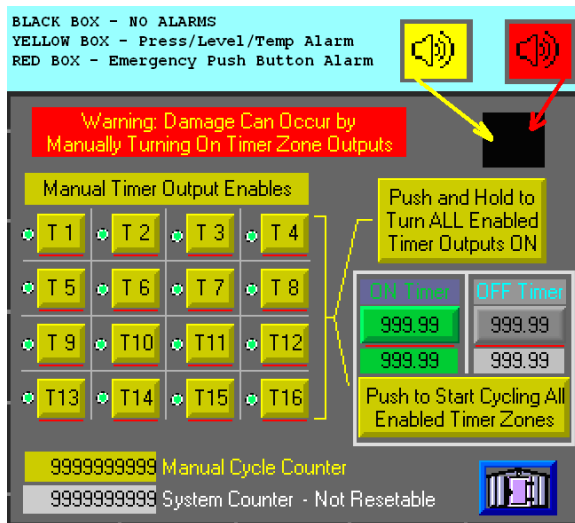

If the Alarm Box is "Black Box" or "Yellow Box" then the Manual Timer Screen Green Indicator should match the Associated GREEN Panel Mounted LED status. If not, check Solid State Relay Fuses inside the cabinet. The GREEN Panel Mount LED can come on from the Automatic Trigger Signal Recipe that is running.

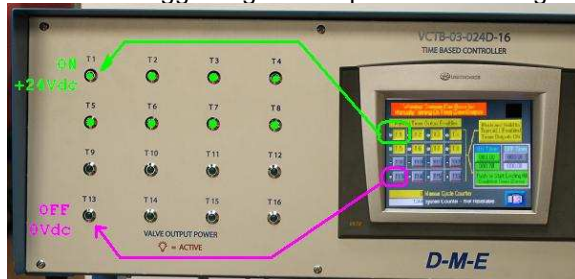

D-M-E Company

VCTB-03-024D-16
EE-000069-0025 REV: B

Manual Push Button Hold On/ Release Off:

Pushing and Holding the "Push and Hold to Turn All Enabled Timer Outputs ON" button turns it GREEN and drives all "Yellow" Enabled T1 to T16 Timers ON – Green LED'S on. Releasing the Button should return them to the OFF state unless an external trigger signal is running them in Automatic Mode. If a RED ALARM is visible, the GREEN LIGHT CIRCLE NEXT TO THE TIMER WILL LIGHT, BUT THE PANEL LED ASSOCIATED WILL NOT LIGHT UP AND NO OUTPUT VOLTAGE (0 Vdc) IS APPLIED.

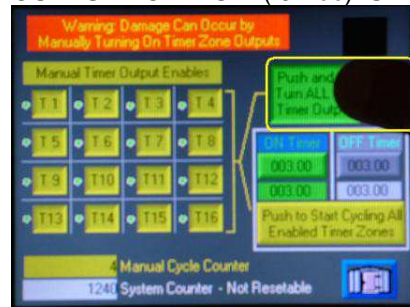

Manual Cycling Mode:

MANUAL CYCLING MODE

PUSH TO ADJUST MANUAL CYCLING "ON TIME" PUSH TO ADJUST MANUAL CYCLING "OFF TIME"

When this timer is active, Enabled T1-T16 Zones should be OFF. Exception if Automatic Triggers/Inj. Fwd. Contact Closures Activating.

When this timer is active, All Timers T1-T16 Zones should be OFF. Exception if Automatic Triggers/Inj. Fwd. Contact Closures Activating.

GREEN BUTTON PRESS STARTS MANUAL CYCLING

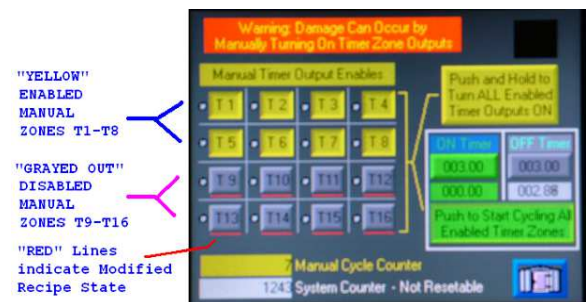
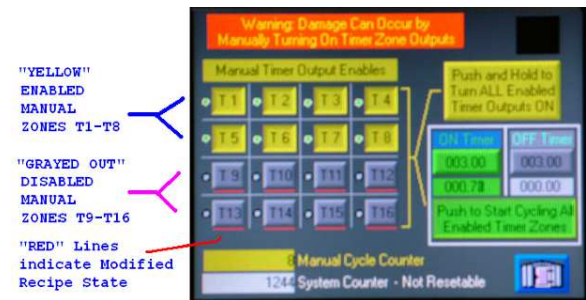

3.8) Save Configuration/Recipe Screen

This will allow the operator to Store the Current Running Operating Parameters into a defined MOLD ID for Storage on the SD Card in the PLC.

SD Data Table folder (DT1) may contain a maximum of 64 .udt files. (Max. Recipes: 64)

There are 2 Sections to the screen.

The **Upper Section** has A or B or C methods and combinations to define a name for the lower screen currently showing "Default" in RED letters.

The **Lower Section** is used to actually write this "Default" name and all the operating parameters for a recipe to the SD CARD when the RED "Press to SAVE/Over-write MoldID Recipe" Button is pressed.

You can **Cancel without Saving** at anytime by pressing the "Building" ICON in the lower right corner which returns you to the "Home Timer Screen".

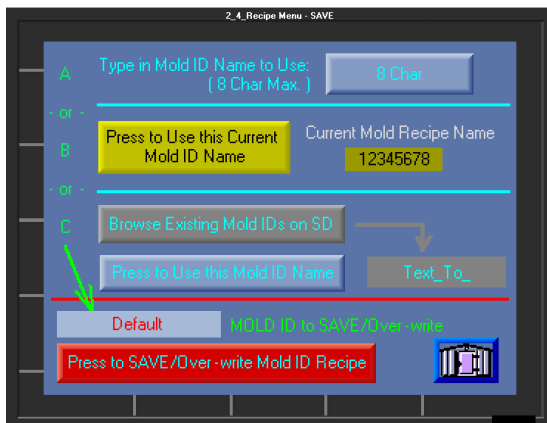

Step 1: UPPER SECTION – Is used to change the RED "Default" "MOLD ID to SAVE/Over-write" Value in the Lower Section.

There are 3 available Methods and combinations of A, B or C which can be used to change the lower "Default" value.

Method A) Type in 8 Characters and Load this into the Lower Define "MOLD ID to SAVE/Over-write" value. Nothing has been stored yet, just defining the MOLD ID name.

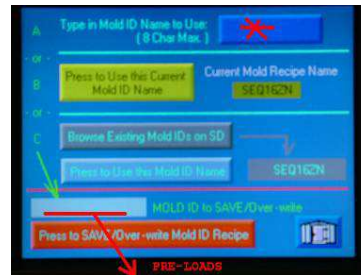

Note: The existing text in the lower Defined area next to "MOLD ID to SAVE/Over-write" will already be pre-loaded as a starting point so the operator can modify it. Example, you can use Method B or C to pre-load a value you want to start with. You might Use Method C to browse existing recipes to help you make sure to not use an existing name that is already stored. When you then use Method A, this value will be pre-loaded in your text area to be modified.



Only 8 Characters allowed. Press "Enter" to use this – it will appear in the lower "Default" Red Text box and the Method A button, or press "ESC" to exit without using this.

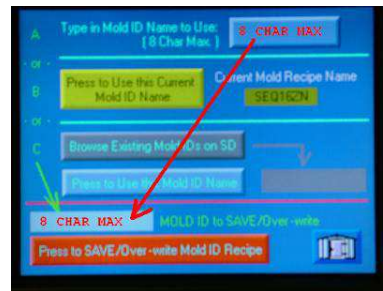

Method B) The current running recipe name is displayed in the Yellow box. Simply "Press to Use this Current Mold ID Name" to transfer it to the lower "Default" value.

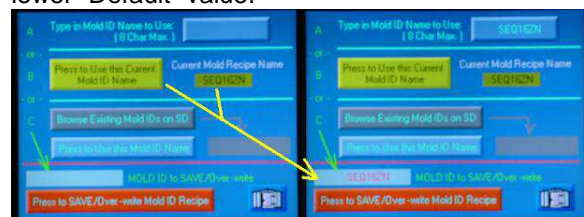

Method C) Browse the SD CARD for existing stored names to use and select one. This does NOT load the recipe, just the Name of the existing Recipe and places it next to this button. To transfer this name to the “Default” name in the lower section “Press to Use this Mold ID Name”.



This method is useful for making sure you do not over-write an existing recipe name by visually checking for a name on the SD Card. You may also delete recipes by selecting the recipe and pressing the Delete button.

Step 2: LOWER SECTION: Press “Press to SAVE/Over-write Mold ID Recipe”

Once the Operator is satisfied with the defined MOLD ID name displayed in the lower MOLD ID box, then the operator Presses the RED “Press to SAVE/Over-write Mold ID Recipe” Button to load this Recipe to the SD Card.
 PLC → SD CARD

New Recipe Saved and Shows up on “Home Timer Screen”.

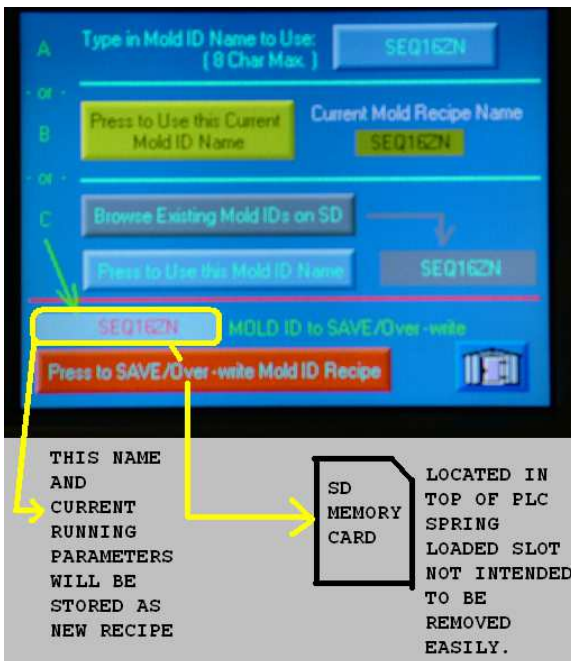

3.9) Load Configuration/Recipe Screen

This will allow the operator to “Browse SD Card Stored Mold IDs” existing stored recipes and Load them to the PLC. SD CARD → PLC

Step 1: Press “Browse SD Card Stored Mold IDs”

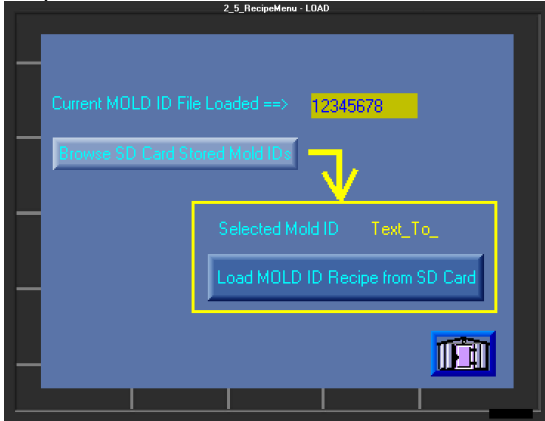

Step 2: Browse Recipes using the up/down arrows. If you want to return, press “ESC” button to cancel this option.

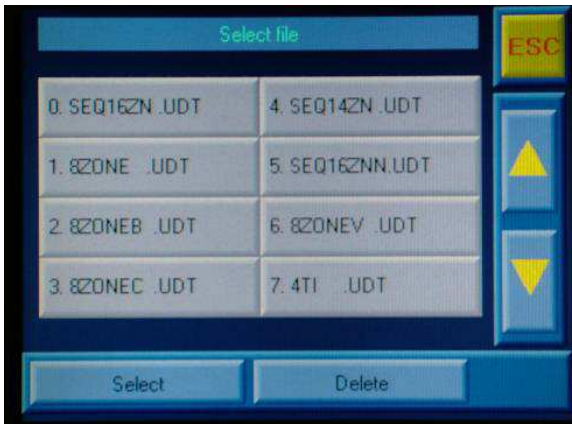

Step 3: Push the Recipe you want “highlighted” then press Select. You can also “Delete” Recipes to maintain your recipe list.



Step 4: Press “Load MOLD ID Recipe from SD Card” which is displayed in Yellow Letters to replace the current recipe shown above in the Yellow Box. If you want to cancel this, simply press the “Building” ICON in the lower right to return to the Home Timer Screen.

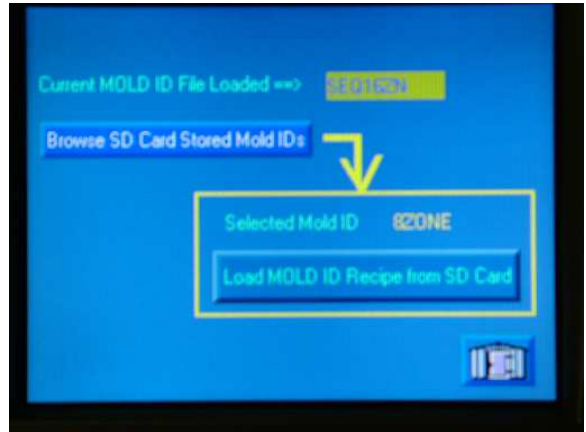

Note: “8ZONE” recipe is selected to Load and the Current Recipe in the PLC in this example is “SEQ16ZN”.

You have loaded a stored recipe “8ZONE”

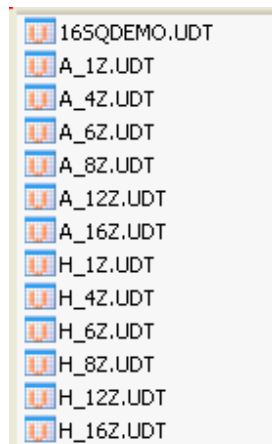

Default stored Recipes on the SD Card.

Blank Configuration/Recipe Worksheet
 DME VCTB-03-024D-16 Time Based Controller

Recipe Name.
 8 Char. MOLD ID _____

TIMER SETUP Screen Recipe Values

Timer	(1 or 0) Enable=0	000.00 to 999.99 sec.xx Delay OFF	ON Time
T1	_____	_____	_____
T2	_____	_____	_____
T3	_____	_____	_____
T4	_____	_____	_____
T5	_____	_____	_____
T6	_____	_____	_____
T7	_____	_____	_____
T8	_____	_____	_____
T9	_____	_____	_____
T10	_____	_____	_____
T11	_____	_____	_____
T12	_____	_____	_____
T13	_____	_____	_____
T14	_____	_____	_____
T15	_____	_____	_____
T16	_____	_____	_____

MANUAL MODE Screen Values

Timer Enable=1 Disable = 0

T 1	___	T 2	___	T 3	___	T 4	___
T 5	___	T 6	___	T 7	___	T 8	___
T 9	___	T10	___	T11	___	T12	___
T13	___	T14	___	T15	___	T16	___

Manual Mode Continuous Cycle Timers

000.00 to 999.99 sec.xx

ON TIME _____ OFF TIME _____

NON-STORED COMPANY RECIPE NOTES:

ALARM Screen Recipe Values

0 = Disable Input , 1 = Enable the Input

Level Switch	LS1 Over-ride	_____
Temperature Switch	TS1 Over-ride	_____
Pressure Switch	PS1 Over-ride	_____

4.0 Troubleshooting.

NOTE: DISCONNECT POWER BEFORE SERVICING. ONLY ELECTRICIANS OR TRAINED SERVICE PERSONNEL SHOULD REMOVE ACCESS PANELS TO SERVICE INTERNAL COMPONENTS.

CAUTION MUST BE TAKEN while performing diagnostics to prevent personnel injury from hot injection molding plastic and pressure that is in the mold being diagnosed. Hot plastic may shoot out when opening / closing the Valve Gate pins in your mold.

Indicator Lights have been strategically placed on the VCTB-03-024D-16 Valve Gate Controller to make troubleshooting easier.

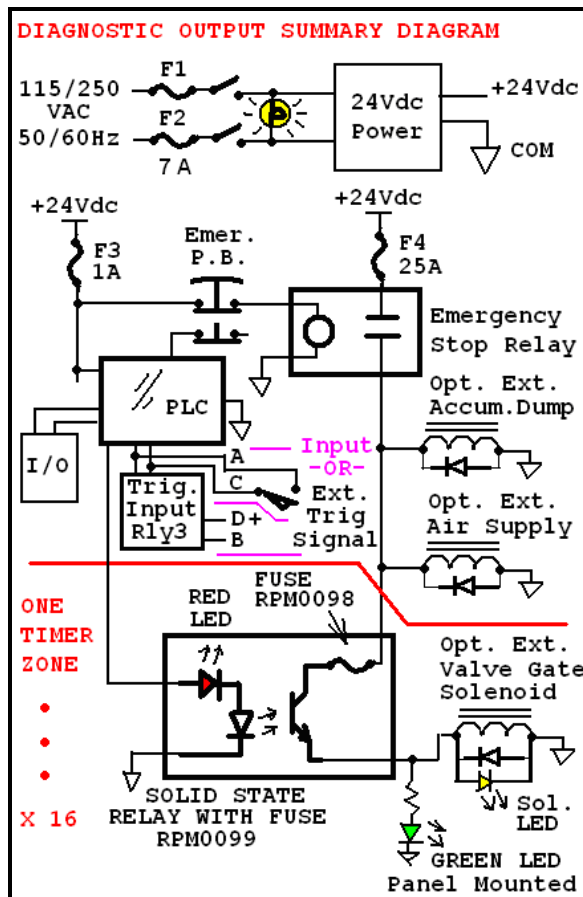

4.1) PLC does NOT power up.

- Make sure controller is plugged in and that outlet power is on. Some molding machine outlets may not be energized if machine power is off.
- If controller is plugged in and outlet has power, check the main power fuses F1 and F2 on side of the controller. A good indication that the Power Supply is running is that the Built in Fan is blowing

air out the side of the mainframe. Use only 3AB Slo-Blo 7amp 250vac fuses as replacements.

- The F3 fuse is located inside the back panel and supplies +24Vdc thru one ABC1 fuse rated at 1 amp.
- If no +24 Vdc power still exists, the switching DC power supply may need replacement. See RPM0121.

4.2) All Expected Timer Zone LED's ON, But valve doesn't work. External Solenoid LED ON, Front Panel LED ON – Controller working properly and valve should be energized - problem outside the box. Check your pneumatic/hydraulic pressure to your valves, your tubing connections, your wiring, your solenoid/valve and your Valve Gate Product in the Mold.

4.3) Front Panel Mount Green LED ON, Solenoid LED OFF.

The Front Panel LED should match the DME External Solenoid LED state.

- Check Output Wiring and Solenoid coil. The LED is wired in Parallel to the zone +24Vdc Output Control Voltage and if it is on, then the voltage should be applied to the pins. You can optionally check the associated output pins with a volt meter to check for +24Vdc while the associated LED zone is ON.

4.4) Manual Diagnostic Mode PLC Screen Indicator ON, the Panel Mount Green LED is OFF.

- Make sure there is NOT a RED ALARM. Make Sure the Emergency Stop Push Button is NOT pressed in. If it is, turn it slightly until it pops/pulls out.
- The Emergency Stop Push Button activates the coil on RPM0120 relay which supplies +24Vdc at 25 Amps to all the Output Solid State Relays and is fused thru F4 for 25 Amps which is RPM0117. Check the F4 Fuse.
- Each Timer Zone has a fused output Solid State Relay RPM0099 with a built-in RED input LED indicator. The RED LED is ON when the solid state relay "Coil" is turning ON the Output, it is NOT indicating the actual state of the output, but what the output should be. When the RED Input LED is ON, the Output should be on and indicated by the front panel mount GREEN LED. The RPM0098 Fuse mounted on the Solid state relay fuses the Output Current for this zone only and may have "opened". Also, the F4 fuse that feeds all these solid state relays may have "opened". They are arranged from the back inside cabinet as follows: from Right to Left and relate to timer zones T1 (right most from rear panel), T2, ..., T16 (left most from rear panel).

4.5) Automatic Mode Troubleshooting

- Review problems described in 4.4 first in manual mode.
- Check the Trigger Input Signal and see if it is working. Open and Close your Trigger Signal and check the Upper Contact Icon for Open/Closed Status. (If using a +24Vdc Trigger signal, apply and remove the signal and check the Upper Contact Icon for Open/Closed Status.)

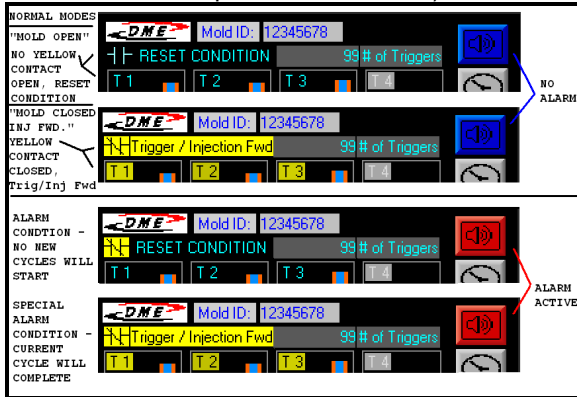

- If using a Voltage Trigger Input, there is an isolation type relay between the signal and the PLC. This RLY3 may need replacing.
- If the contact closure does not work, a Complete "PLC Snap-in I/O" module may need to be replaced and can be special ordered - (reference Unitronics V200-18-5EB)
- Make sure your setpoints are entered properly.

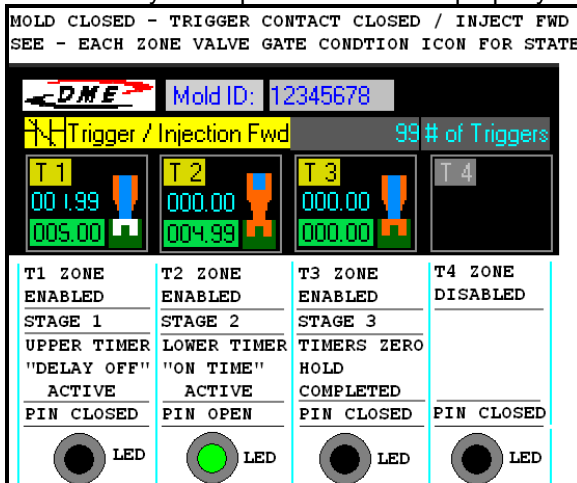

- Check cable connection(s) between the controller and the valve(s). If cable damage is suspected, replace the cable.
- If the valve cable is determined to be good, check the small fuses on top of the internal solid state relays. If any of these fuses are determined to be open, check the affected zone valves and cable connections for short circuits. Replace defective fuses only after determining that the related valves and connections are in good order.

The controller was designed to run valves with coil powers as high as 35 watts.

- If the fuses on top of the solid state relay are good, it is possible that a solid state relay may require replacement. Replacement fuses and relays are available from DME.

4.6) Alarm Status Screen – Make sure NO ALARMS Exist.

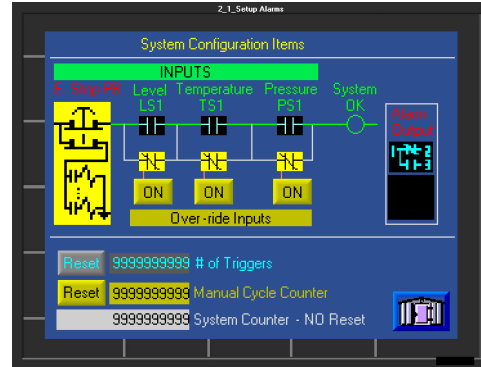

Upper Corner of Home Timer Screen



BLUE ALARM

5.0 Components, Maintenance and Repair.

5.1 What's In the Box:

- (1) VCTB-03-024D-16 Controller w/ 120Vac plug.
- (1) SDHC Recipe Flash Card installed in PLC.
- (1) RPM0101 Trigger Cable
- (1) Alarm Out Connector and crimp pins.
- (1) Main Out 1 Hood, Insert 1-16, Grommet
- (1) Main Out 2 Hood, Insert 17-32, Grommet.
- (1) User Manual
- (4) Optional Use Input Cord Grips

5.2 Customer Connections and Items Not Supplied:

- Trigger Signal source to start the Cycle, typically Injection Forward. A Contact Closure or +24Vdc Signal.
- Recommended Optional Alarm Output Contact Input on the Injection Molding Machine to stop the next Cycle.
- Customer Supplied Electrical Power
 - 115-250 Vac 50/60 Hz,
 - Internally Fused Slow blow Fuses at 7 Amps.
 - Inrush Current at 115 Vac is 20 Amps
 - Inrush Current at 230 Vac is 40 Amps
- 19 Ft. USA 120 Vac 15Amp 3 prong plug supplied, customer responsible for other plug requirements.

5.3 Optional Items for the Controller:

FSSL-0001 SmartSeries® Slanted Floor Stand.

MFS-512-G SmartSeries® Straight Floor Stand.

FSEXT-0001 SmartSeries® Floor Stand

Extension Angle Iron Brackets for mounting a DME SmartSeries Hot Runner Temperature Control System above the Valve Gate Controller.

5.4 Replacement Part Numbers

(Timer 16 Solid State Relay is shown with "E" and "F" for ref.)

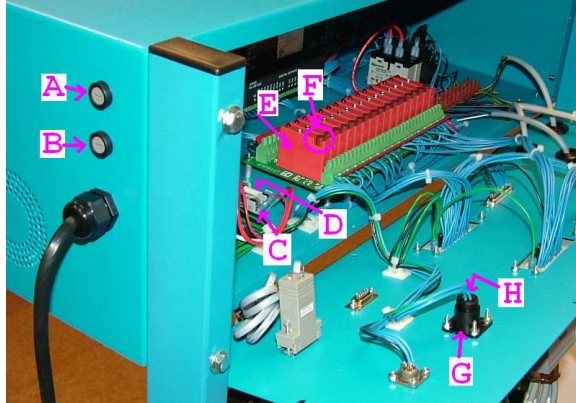

- A = F1, 115-255Vac Main Fuse, see RPM0122
- B = F2, 115-255Vac Main Fuse, see RPM0122
- C = F3, 24Vdc PLC Fuse, see ABC1
- D = F4, 24Vdc Outputs Main Fuse, see RPM0117
- E = Zone Solid State Relay, see RPM-0099
- F = Zone Solid State Relay Fuse, see RPM-0098
- G = Alarm Panel Mount Recept., see RPM0029
- H = Alarm Male Pins for G, see RPM0031



- I = Trigger Cable, see RPM0101
- J = Alarm Connector Plug, see RPM0030
- K = Alarm Female Pins for J, see RPM0032

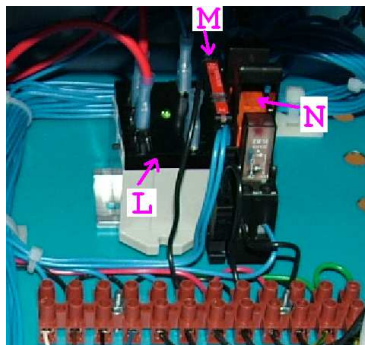

- L = Em. Off 24Vdc Output Relay, see RPM0120
- M = Trigger Isolation Relay Input, see RPM0119
- N = Alarm Output Relay, see RPM0118

D-M-E Company

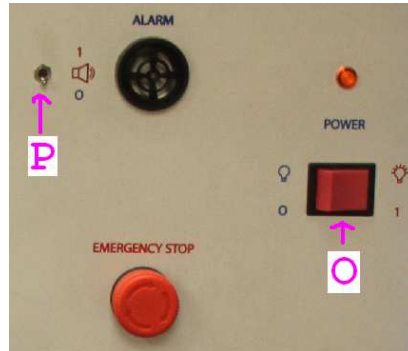

- P = Alarm Horn Toggle SW3, see RPM0028
- O = Power Switch SW1, see RPM0008

Catalog Item #	DESCRIPTION
RPM0122	F1, F2 Fuse, 7A Slow Blow
ABC1	F3 Fuse
RPM0117	F4 Fuse, 25A Slow Blow
RPM0008	SW1 Power Switch, 16A, 250Vac
RPM0028	SW3 Alarm Horn Switch
RPM0029	P22 Alarm Panel Mount Receptacle
RPM0030	P22 Alarm Connector Plug – Accessory
RPM0031	P22 Alarm Panel Mount Receptacle Pins, Male
RPM0032	P22 Alarm Connector Plug Pins, Female – Accessory
RPM-0099	I/OMOD1 Solenoid Output Solid State Relay
RPM-0098	I/OMOD1 Solid State Relay Fuses (4 amp, 250 VAC)
RPM-0101	P21 Trigger Cable
RPM0118	RLY2 Alarm Output Relay
RPM0119	RLY3 Trigger Input Relay
RPM0120	RLY1 Emergency Off Relay
RPM0121	PS1 600 Watt +24Vdc Power Supply, 115-250 Vac Input.

RETURN POLICY

The D-M-E® VCTB-03-024D-16™ is warranted for 90-days parts and labor, excluding fuses. Contact D-M-E Customer Service for return authorization for repairs, or warranties. Replacement parts are also available through the Customer Service Department.

D-M-E Customer Service

In U.S.: 1-800-626-6653
In Canada: 1-905-677-6370

SERVICE CENTER U.S.A.

D-M-E WORLD HEADQUARTERS
29111 STEPHENSON HIGHWAY
MADISON HEIGHTS, MICHIGAN 48071
www.dme.net see North America Site – Products & Services
D-M-E® is a registered trademark of D-M-E Company.

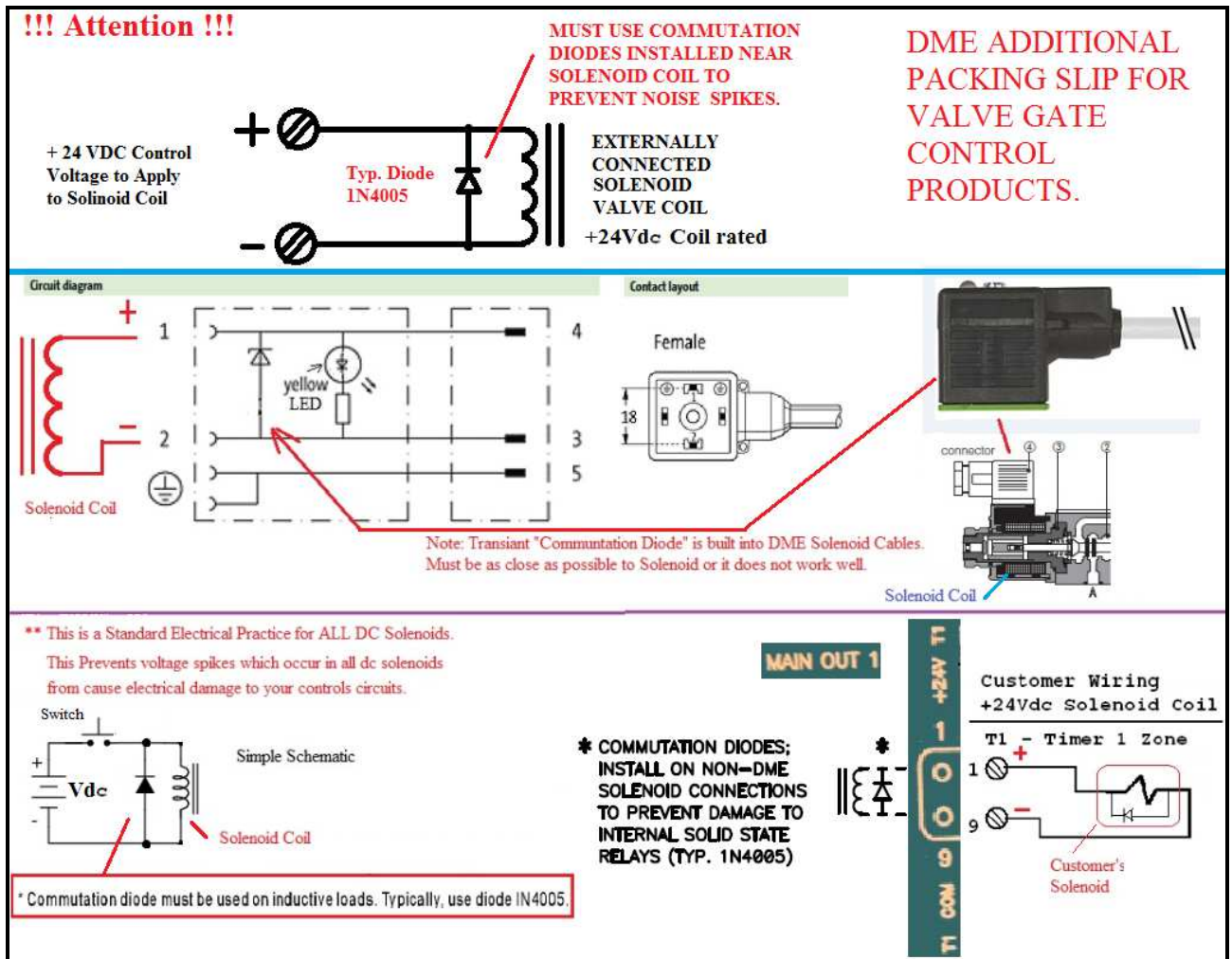

NOTES:

ECN'S:

ECN-E0700 11/14/14 Added Notes and Electrical Schematic overview Figures showing Commutation Diodes to External DC Valve Solenoids to clarify customer hookup requirements. DME designed components to work with the controller have the Commutation Diodes built into them. Commutation Diodes are commonly used in all solenoid circuit to reduce inductance kick back type electrical spikes which can cause damage to semiconductor controls.

APPROVAL:

CHECKED BY: T. JOHNSTON DATE: 11/14/14

APPROVED BY: C. KOVACIC DATE: 11/14/14