

TCM-03-024D

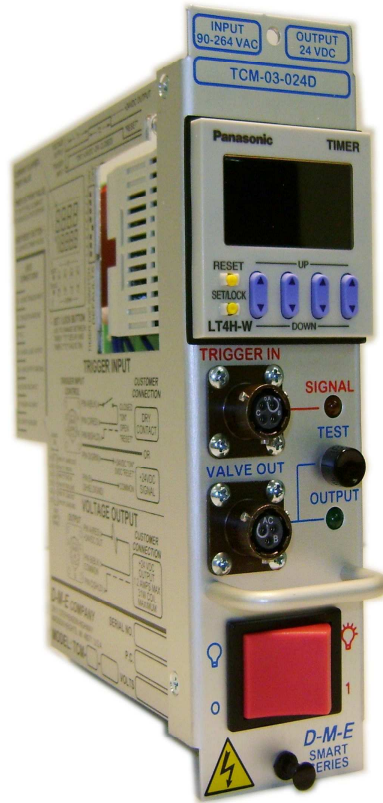

Single Zone, 24 Volt DC Timer Control Module

User's Manual

D-M-E Company

SAFETY

D-M-E Company products have been designed to be safe and simple to operate. As with any electronic equipment, you must observe standard safety procedures to protect both yourself and the equipment.

To Prevent Injuries:

- To avoid electrical shock or fire hazard, do not apply voltage to a terminal that exceeds the range specified for that terminal.
- To avoid mechanical injury, electrical shock or fire hazard, do not operate this product with covers or panels removed.
- To avoid electrical shock or fire hazard, do not operate this product when wet.
- To avoid injury or fire hazard, do not operate this product in an explosive atmosphere.
- To avoid burn hazards, do not operate valve gates with operator gates open. Correct hookup of valve gates should only be performed with all operator guards in place.
- To avoid burn hazards and possible damage to equipment, do not leave hot runner systems at elevated temperature for extended periods of time. When the mold and machine are not operating, disconnect the molding machines injection unit from the hot runner system so that pressure may discharge through the sprue or manifold extension nozzle. Make sure the molding machines purge guard is in place.

To Prevent Product Damage:

- Do not operate this product from a power source that applies more than the voltages specified.
- Do not apply any external voltage to the injection forward input. Only a contact closure or solid-state relay should be used as an input.

DME RIGHTS

Copyright © D-M-E Company 2009. All rights reserved.

D-M-E Company products are covered by USA and foreign patents, issued and pending. Information in this publication supersedes that in all previously published material. Specifications and any changes are reserved.

Printed in the United States of America

D-M-E Company
29111 Stephenson Highway
Madison Heights, MI 48071

D-M-E Company and D-M-E are registered trademarks of D-M-E Company.

WARRANTY

D-M-E Company warrants that this product will be free from defects in materials and workmanship for a period of three (3) years from the date of shipment. If any such product proves defective during this warranty period, D-M-E Company, at its option, either will repair the defective product without charge for parts and labor, or will provide a replacement in exchange for the defective product.

This warranty shall not apply to any defect, failure or damage caused by improper use or improper or inadequate maintenance and care. D-M-E Company shall not be obligated to furnish service under this warranty a) to repair damage resulting from attempts by personnel other than D-M-E Company representatives to repair or service the product; b) to repair damage resulting from improper use or connection to incompatible equipment; or c) to service a product that has been modified or integrated with other products when the effect of such modification or integration increases the time or difficulty of servicing the product.

GENERAL DESCRIPTION

This manual describes the installation, operation and servicing of the Timer Control Module.

The TCM-03-024D Controller is designed to provide time based control for a single 24 volt DC Output device, such as solenoid valves used to actuate pneumatic valve gate cylinders. It can also be used to operate some hydraulic valves. The TCM-03-024D is small in size and is designed to fit in a single Smart Series® Mainframe 15 Amp Slot so that it is easy to integrate with the hot runner temperature control system.

The Controller uses a DIN style solid-state timer to provide long life and high reliability. The timer is capable of dual time functions so that it can be programmed with a delay time (timer 1) and an on time (timer 2). The timer in turn drives a larger solid-state relay that is individually fused against faults.

The Controller is designed to operate from a wide supply of operating voltages (88 to 264 Volts AC) so that this one device can be used with almost any available power source. This also makes it easier to relocate the controller between different plants or even different countries.

A single 3 pin Circular connector and 20 foot cable connects the controller to a remotely located device, such as a solenoid valve, minimizing connections and thereby making the molding environment neater.

A Test button is available to assist in determining the correct hookup of the controlled output device.

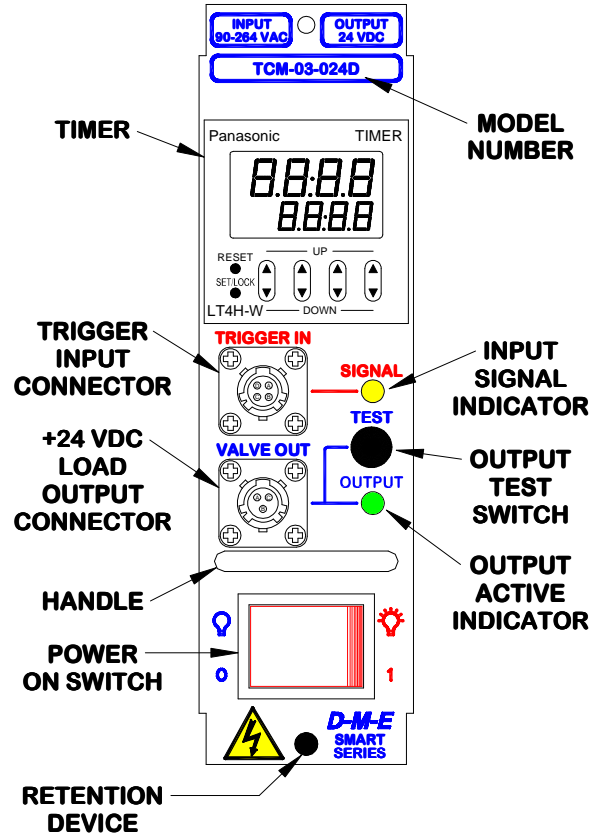

Fig. 1: Controls and Indicators

UNPACKING AND INSPECTION

After unpacking inspect your controller and check for any damage that may have occurred during shipment.

Check for proper operation of the power switch by turning the switch on and off with no voltage applied.

Check all electrical connectors for visual damage.

If any damaged is observed immediately return the controller to D-M-E for repair or replacement.

INSTALLATION

You are installing a piece of electronic equipment that should not be subjected to any physical or environmental abuse. Select a cool, dry, well-ventilated, environmentally clean location, away from heat, moisture and liquid carrying lines, i.e.: water cooling hoses, hydraulic hoses, etc. for set-up.

TRIGGER SIGNAL CONNECTION

The Trigger Signal input can be applied to the TCM-03-024D timer controller in two (2) different ways:

1. The +24Vdc Trigger Version allows multiple units to be daisy-chained together with one (1) Trigger Signal.
2. The Dry Contact version requires an isolated dry contact for each timer unit used.

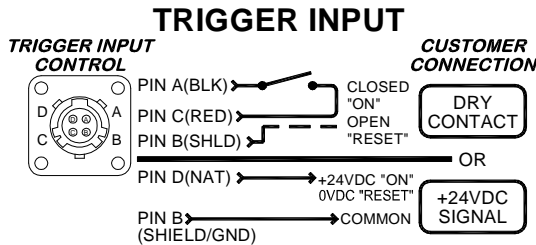

The included 20' cable assembly with mating 4 pin cable connector should be used to connect either the dry contact or +24 Vdc trigger signal to the controller.

The best way to accomplish this is to supply a *dry contact (relay) closure* that is triggered by the injection forward signal of the molding machine. A solid state relay contact can be also be used. It should source power from contact A to contact C.

Alternately, a limit switch can be used as the trigger signal that is operated from mold closure. A limit switch can be mounted to the tie bar to catch the closing of the moving half of the mold. It may also be mounted to the mold to detect contact of the mold halves.

The Trigger Signal can be applied to either:

1. The "TRIGGER" four position connector on the controller front pane. This is the factory default connection.
2. To the appropriate mainframe edge connector finger contacts on the controller printed circuit board.

Note: To use the edge finger contacts the operator must insure that the mainframe zone has been properly wired for TCM-03-024D timer control operation. The signal input and control output wiring to the white edge connector of a standard temperature control mainframe is different than what is required for the timer control module.

To change the trigger input circuit from the factory default front panel connector to the alternative printed circuit board edge connector finger contacts, it is necessary to move the input signal jumpers of P4 on the TCM printed circuit board assembly:

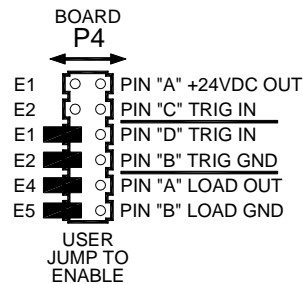

Fig. A: Factory Default all jumper positions open. Trigger input and load output via the front panel connectors only.

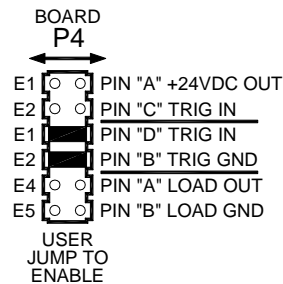

Fig. B: Install jumpers as shown for dry contact closure trigger input via the edge connector fingers.

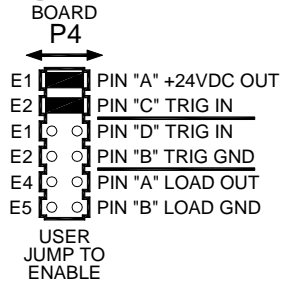
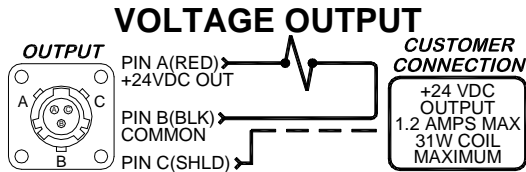

Fig. C: Install jumpers as shown for +24 Vdc trigger input via the edge connector fingers.

CONTROLLER TO VALVE CONNECTION

The included 20' cable assembly with mating 3 pin cable connector should be used to connect the controller output to the +24 Vdc device to be controlled. The cable provided has conductors with a minimum size of 20 gauge to run *solenoid hydraulic* valves with up to 31 watt coils.



The Output Signal is available from either:

1. The "VALVE OUT" three position connector on the controller front panel. This is the factory default connection.
2. The appropriate mainframe edge connector finger contacts on the controller printed circuit board.

Note: To use the edge finger contacts the operator must insure that the mainframe zone has been properly wired for TCM-03-024D timer control operation. The signal input and control output wiring to the white edge connector of a standard

temperature control mainframe is different than what is required for the timer control module.

To change the output circuit from the factory default front panel connector to the alternative printed circuit board edge connector finger contacts, it is necessary to move the output signal jumpers of P4 on the TCM printed circuit board assembly:

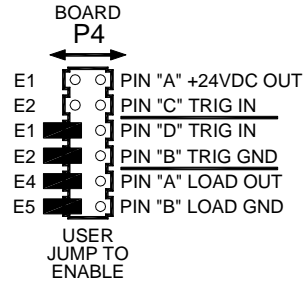

Fig. D: Factory Default all jumper positions open. Trigger input and load output via the front panel connectors only.

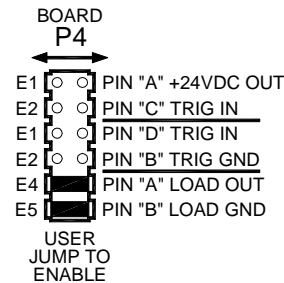

Fig. E: Install jumpers as shown for +24 Vdc OUTPUT via the edge connector fingers.

CONTROLLER AC POWER CONNECTION

The controller was designed to operate in any single wide Smart Series® Mainframe Zone Slot. The controller is designed to run from any voltage between 88 VAC and 264 VAC.

NOTE: ALL NATIONAL AND LOCAL ELECTRICAL CODES MUST BE FOLLOWED WHEN CONNECTING THIS EQUIPMENT.

OPERATION

Timer Setup

Do not perform this step until all electrical connections are performed!

Turn controller power on. The timer displays should illuminate. If they do not illuminate see the Maintenance and Repair sections below.

The large, top digital display is for elapsed time once the count has been initiated.

The smaller, lower digital display is used for both (two) internal timer setpoints:

1. Timer 1 sets the delay between when the trigger signal is received and the valve is to open. This is referred to as the "delay" timer.
2. Timer 2 sets the duration the valve is open. This is referred to as the "on" timer.

Note: The SET / LOCK Button shown below is used to change between and activate the T1 and T2 setpoint displays. The "T1" or "T2" icon will illuminate to indicate which timer is active, either while a count is in process or when the user is changing the setpoints.

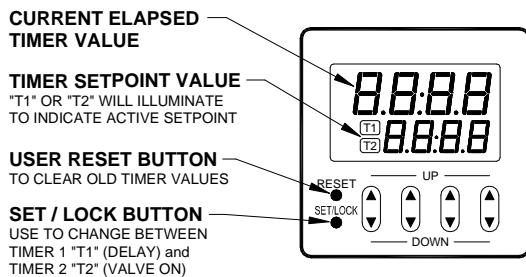

Changing The Timer Setpoints

Use the SET/LOCK button on the front of the timer to select between the delay timer (Timer 1) and the on timer (Timer 2).

Use the up and down arrow buttons below the display to set the desired time value. Each time value can be set to any value between 00.00 seconds to 99.99 seconds.

To set any Voltage Output Device to open immediately set the delay timer (Timer 1) value to 00.00 seconds.

If the sum of the delay and the on timer is set to a value larger than the time the trigger signal is active, internal electronics will automatically reset the timers at the end of the trigger signal.

When triggered, "Timer 1" (delay timer) will be displayed. The timer will count down until it reaches zero. When Timer 1 reaches zero, Timer 2 (on timer) will be displayed and the timer will count down until it reaches zero. If the Timer 1 value is zero, Timer 2 will be displayed when the trigger signal is displayed, Timer 1 will not be displayed.

The graph below details the relationship between the T1 timer count and T2 timer count over time when a count is initiated by the trigger input signal.

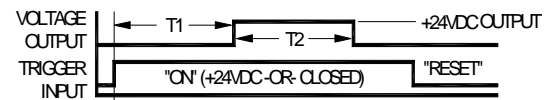

For valve gate operation the proper setting of each of the "on" timers is determined by part weight or size. For most applications the on timer should run through the injection fill phase and into the pack (and hold, if present) phases of the injection-molding machine.

NOTE: The TEST button on the front panel does *not* actuate the timer. The button bypasses the timer and actuates the solid-state relay directly, energizing the +24Vdc output.

The test button on the controller can be used to verify correct connection to the Voltage Output (if using valve gates). **Warning!** verification should be performed with the operator gates closed to prevent injury from hot plastic.

Verify correct operation of the timers once the trigger signal is applied.

MAINTENANCE AND REPAIR

NOTE: DISCONNECT POWER BEFORE SERVICING. ONLY ELECTRICIANS OR TRAINED SERVICE PERSONNEL SHOULD REMOVE ACCESS PANELS TO SERVICE INTERNAL COMPONENTS.

Timer Does Not Illuminate

Make sure controller is plugged into a Smart Series® Mainframe and that outlet power is on. The mainframe circuit breaker must be on and the controller rocker power switch must be on. Some molding machine outlets may not be energized if machine power is off.

If controller is plugged in and outlet has power, check fuses 1 and 2 on the printed circuit board (refer to Fig. 2). Use only ABC-3 fuses as replacements.

If the timer does not illuminate it may require replacement. See timer replacement at the end of this section. The timers are designed to operate for 10 million cycles so the need to replace them should be uncommon.

Timers Illuminate But Don't Run

Check the trigger signal cable and make sure it is connected. If the cable is connected, disconnect the cable from the controller and ensure the molding machine provides a contact closure when expected by checking for contact closure between pins A and C (dry contact trigger) or for +24Vdc between pins D and B (+24Vdc trigger) of the front panel connector (The Yellow *Signal* LED illuminates when a closed contact or +24Vdc signal is present and connected properly.)

To verify correct controller operation a jumper wire / paper clip can be used to short pins A & C. The yellow *Signal* LED will illuminate if the controller is operating properly.

Timer Runs But Valve Does Not

Check the cable connection between the controller and the valve (or other +24Vdc load). If cable damage is suspected replace

the cable. The Green *Output* LED will illuminate when the output signal is activated. The Test button should turn on the Green LED when pressed and held.

If the valve cable is determined to be good check the small fuse on top of the internal solid-state relay (see Fig. 2). If the SSR fuse is open the output of the SSR / timer controller will be inhibited. If it is determined that the fuse is open check the affected output and cable connections for short circuits or other potential causes of fuse damage. Replace defective fuses only after determining that the related output and connections are in good order. *The controller was designed to run outputs or valves with coil powers as high as 31 watts.*

A spare SSR fuse is provided in the holder at the top left of the printed circuit board (see Fig. 2).

If the fuse on top of the solid-state relay is good it is possible that a solid-state relay may require replacement. Replacement fuses and relays are available from DME (see the replacement parts table at the end of this manual).

Timer Replacement

If timer replacement appears to be necessary we recommend returning the unit to DME or have it serviced by another known qualified service technician. Replacement timers are available from DME. Use part number RPM-0100.

The replacement timer must be setup before installation. A small access plate on the right side of the timer gives access to a bank of small switches. Open the plate and set all switches except switch number four (4) to "ON". Replace the damaged timer making sure to connect all wires in the proper location. Tighten all unused screws.

Timer Default DIP Switch Settings

TIMER DIP SWITCH
DEFAULTS



The diagram shows a row of eight DIP switches labeled 1 through 8. Switch 1 is ON (up), switch 2 is ON (up), switch 3 is ON (up), switch 4 is OFF (down), switch 5 is ON (up), switch 6 is ON (up), switch 7 is ON (up), and switch 8 is ON (up). To the right of the switches, 'ON' is indicated by an upward-pointing arrow and 'OFF' by a downward-pointing arrow.

The first time a replacement timer is powered up, set the timer to “Integrate A” mode by performing the following:

- (1) Press and hold the SET/LOCK button.
- (2) Press the most right up or down arrow.
- (3) Release the SET/LOCK button.
- (4) Continue pressing the right most up or down arrow until “In-A” is displayed.
- (5) Press the reset key.

The replacement timer is now ready for use.

OUTPUT CURRENT LIMITATIONS

The TCM-03-024D controller is designed to power an output device with a maximum power requirement of approximately 31 watts. This is usually sufficient to power solenoids controlling hydraulic valves typically used with valve gate controls.

CABLES AND CONNECTORS

The required power output and trigger signal cable assemblies are provided with the controller kit.

REPLACEMENT PARTS	
DESCRIPTION	CATALOG NUMBER
Fuse 1 and 2	ABC-3
Solid State Relay Fuses (T5 series, 4 amp, 250 VAC)	RPM-0098
Solid State Relay	RPM-0099
Replacement Timer	RPM-0100
Trigger Cable	RPM-0101
24 Vdc Load Cable	RPM-0108

RETURN POLICY

The D-M-E® TCM-03-024D™ is warranted for 1-year parts and labor, excluding fuses. Contact D-M-E Customer Service for return authorization for repairs, or warranties. Replacement parts are also available through the Customer Service Department.

D-M-E Customer Service

In U.S.: 1-800-626-6653
In Canada: 1-905-677-6370



U.S.A. SERVICE CENTER

D-M-E WORLD HEADQUARTERS

29111 STEPHENSON HIGHWAY
MADISON HEIGHTS, MICHIGAN 48071
TELEFAX: (248) 398-6174

D-M-E® is a registered trademark of D-M-E Company.

Typical Example Setups:

DME Single Zone Timer: TCM-03-024D
Shows fitted to a DSM-TS-12 Temperature Controller in a Standard 7 Zone Smart Series Multichrome.

D-M-E COMPANY **TCM-03-024D**
INPUT VOLTAGE: 90-264 VAC
OUTPUT POWER: 24 VDC / 1.2 AMPS

TRIGGER INPUT

TRIGGER INPUT CONTROL

CUSTOMER CONNECTION

PIN A (BLK) → CLOSED "ON"
PIN C (RED) → OPEN "RESET"
PIN B (SHLD) → "RESET"

OR

PIN D (NAT) → +24VDC "ON"
0VDC "RESET"

PIN B (SHIELD/GND) → COMMON

+24VDC SIGNAL

VOLTAGE OUTPUT

OUTPUT

CUSTOMER CONNECTION

PIN A (RED) → +24VDC OUT
PIN B (BLK) → COMMON
PIN C (SHLD) →

+24 VDC OUTPUT
1.2 AMPS MAX
31W COIL
MAXIMUM

ELAPSED CURRENT TIMER VALUE
TIMER SETPOINT VALUE
"T1" OR "T2" WILL SHOW FOR ACTIVE SETPOINT
USE RESET BUTTON TO CLEAR OLD TIME VALUES
USE SET/LOCK BUTTON TO CHANGE BETWEEN TIMER 1 (DELAY) AND TIMER 2 (VALVE ON)

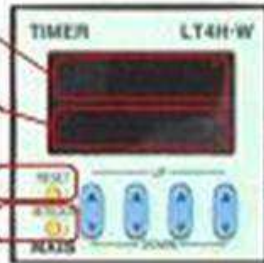

Voltage Output

Trigger Input SIGNAL

← T1 → ← T2 →

+24Vdc Output

"ON" (+24Vdc -OR- Closed) "RESET"

OPTIONAL MAINFRAME SIDE CONNECTOR WIRING

STANDARD MAINFRAME CONNECTOR WIRING

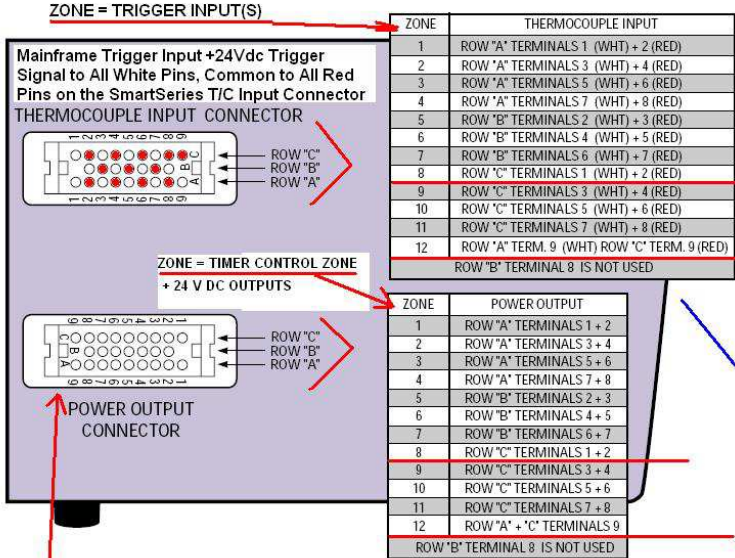

SPECIAL DME SMARTSERIES MAINFRAME THEROCOUPLE INPUT CABLE WITH WHITES TIED TOGETHER AND REDS TIED TOGETHER TO PIGTAILED INDIVIDUAL WIRES AS SHOWN FOR ONE TRIGGER +24VDC INPUT SIGNAL.



TYPICAL DME MFP8G Mainframe with (8) TCM-03-024D Timer Control Modules

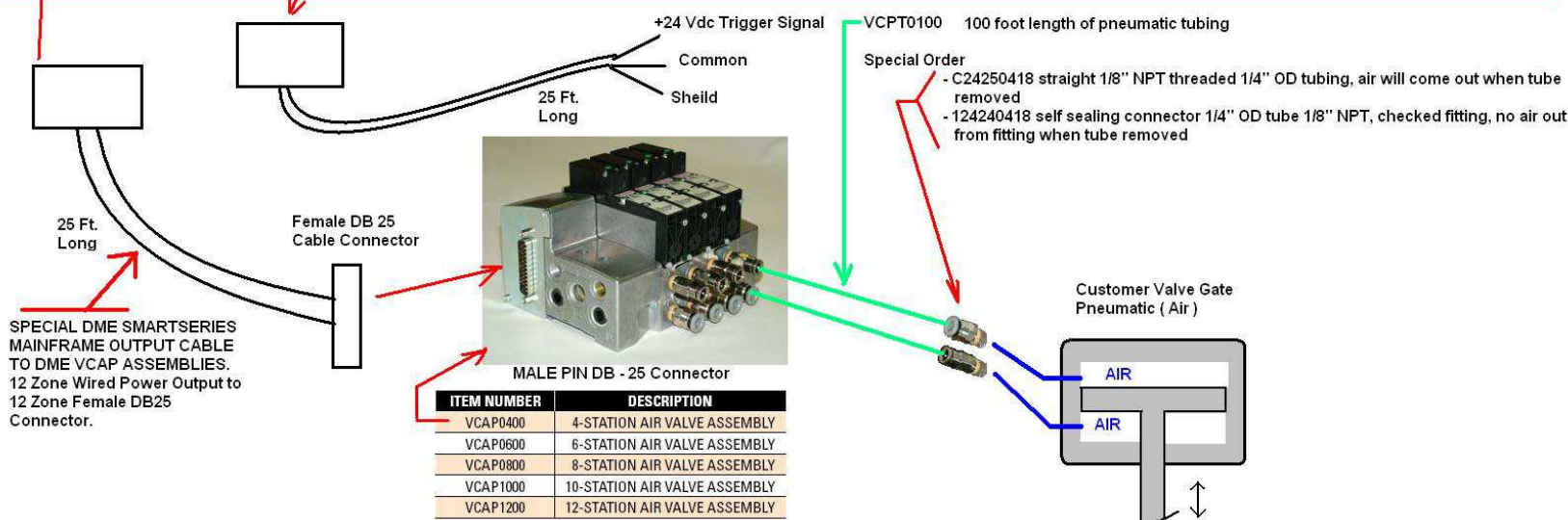
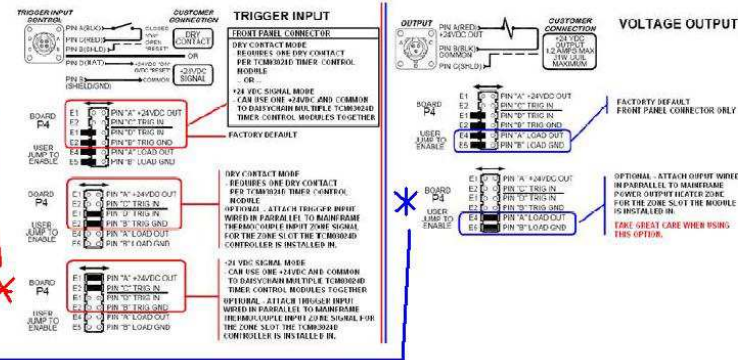

Alternate Jumper Selection Feature when using the DME Multiple TCM-03-024D Timer Control Modules



TYPICAL DME MFP8G Mainframe with (4) Temp. Control and (4) TCM-03-024D Timer Control Modules



TYPICAL DME MFP8G Mainframe with (8) TCM-03-024D Timer Control Modules

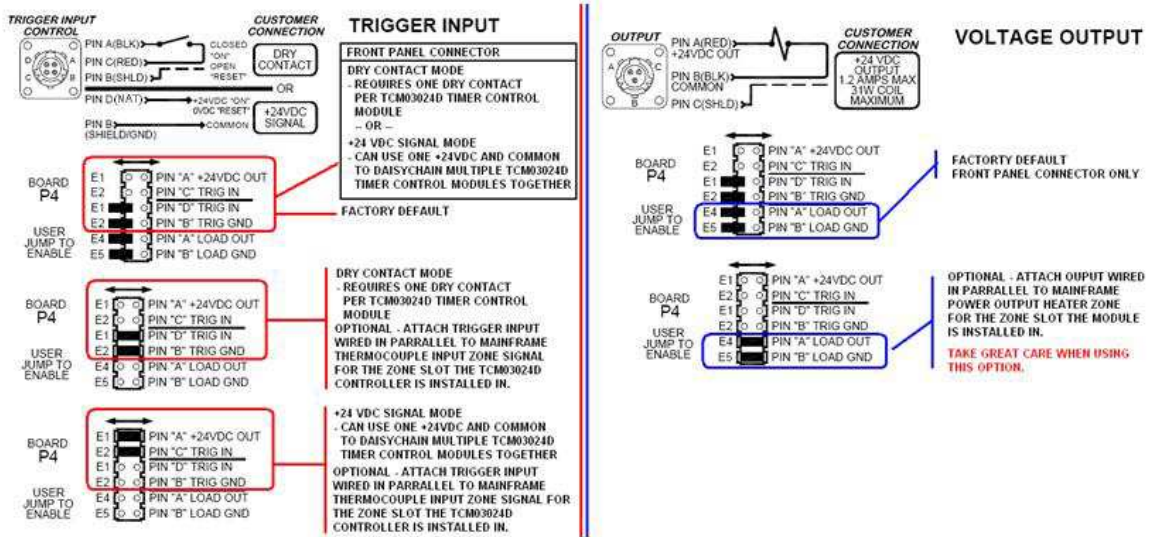

NOTES:

ECN'S:

Rev B: Changed Conflicting RPM108 (was RPM107 on Rev A.) Added Trigger Note for injection forward signal. Added Three Typical Example Setups pictures.

Rev C: Changed trigger cable wiring diagram Pin "D" conductor insulation from green (GRN) to natural (NAT) to agree with RPM0101 Trigger Cable assembly drawing ED-0109-AS-025-C.

APPROVAL:

CHECKED BY: _____ DATE: _____

APPROVED BY: _____ DATE: _____