

Smart Series TSP Plus User Manual

with MTS Console



ITSP-12-15, ITSP-24-15 & ITSP-48-15



REMOVE AND KEEP THIS
SHEET SOMEWHERE SAFE

Every machine leaves our factory with two levels of password protection. We recommend that you remove this sheet in order to establish your own security.

User Password - unix
System Password - linux

Table of Contents

Section 1 - Introduction	1-1
1.1 INTENDED USE	1-1
1.2 AUDIENCE	1-1
1.3 REQUIRED USER SKILLS	1-1
1.4 RELEASE DETAILS	1-1
Section 2 - Safety Instructions	2-1
2.1 SAFETY NOTICES - AN EXPLANATION	2-1
2.2 WHERE TO USE THIS EQUIPMENT	2-1
2.3 CHECK YOUR WIRING	2-2
Section 3 - Overview	3-1
3.1 SPECIFICATION	3-1
3.2 THE CONTROLLER CABINET	3-2
3.2.1 CONTROLLER MODULES	3-2
3.2.2 POWER SUPPLY	4-2
3.3 HOW TO ISOLATE THE CONTROLLER	3-3
3.3.1 SWITCHING ON	3-3
3.3.2 SWITCHING OFF (OR SHUTTING DOWN)	3-4
3.4 SCREEN LAYOUT & NAVIGATION	3-5
3.5 MAIN PAGE	3-6
3.5.1 MONITORING	3-6
3.6 MAIN PAGE – DISPLAY OPTIONS	3-7
3.7 MAIN PAGE - START, STOP & MORE OPTIONS	3-8
3.8 MAIN PAGE – SETTING TEMPERATURE	3-9
3.9 MORE PAGES	3-11
3.10 THE USER INTERFACE	3-13
Section 4 - SetUp	4-1
4.1 STAGES INCLUDED IN SETTING UP A CONSOLE	4-2
4.1.1 CREATE A FIRST TOOL	4-2
4.1.2 SET UP TOOL PARAMETERS	4-2
4.1.3 CONFIGURE SYSTEM SETTINGS	4-2
4.1.4 SET UP OPERATING PARAMETERS	4-2
4.2 CREATE A FIRST TOOL	4-3
4.2.1 SETUP PAGE - CARDS THAT MAY BE DETECTED	4-4
4.3 HOW TO CONFIGURE THE CONTROL CARDS	4-5
4.4 PRE-CONFIGURED SETUP VALUES	4-7
4.5 SETTING THE TOOL PARAMETERS	4-8
4.6 THE TOOL PARAMETERS	4-9
4.7 CONFIGURING THE CONTROLLER	4-12
4.8 THE GLOBAL PARAMETERS	4-13
4.9 SETTING OPERATING PARAMETERS	4-16
4.10 SET PROBE AND MANIFOLD TEMPERATURES	4-18
4.11 SAVING EVERYTHING TO A TOOL BANK	4-19
4.12 SETTING UP OTHER UTILITIES	4-20
4.13 PASSWORD OPTIONS	4-23
4.13.1 THREE LEVELS OF CONTROL	4-23
4.13.2 TWO LEVELS OF CONTROL	4-23

4.13.3 ABOUT PASSWORD ACTIVE TIMES	4-23
4.13.4 PASSWORD APPLICATION TABLE	4-24
4.13.5 PASSWORD SECURITY	4-24
4.13.6 EDIT SYSTEM PASSWORD	4-24
4.13.7 EDIT USER PASSWORD	4-25
4.13.8 SETTING YOUR PASSWORD TIMER	4-25
4.13.9 PASSWORD OVERRIDE	4-25
4.14 CONFIGURING A PRINTER	4-26
4.14.1 USING THE USB SOCKET FOR A LOCAL PRINTER	4-26
4.15 MORE UTILITIES FUNCTION BUTTONS	4-27
4.15.1 EXPORT	4-27
4.15.2 EXIT	4-27
4.15.3 QUAD IO	4-27

Section 5 - Operation5-1

5.1 CONTROL MODES FOR ALL ZONES (FROM THE MAIN PAGE)	5-2
5.2 CONTROL FOR INDIVIDUALLY SELECTED ZONES	5-3
5.3 MORE ABOUT USING BOOST	5-4
5.3.1 MANUAL BOOST DISPLAY	5-4
5.3.2 REMOTE BOOST DISPLAY	5-4
5.4 USE MAIN PAGE TO CHANGE TEMPERATURES	5-5
5.5 USING THE MAIN PAGE TO CHANGE MODES	5-6
5.6 MORE ABOUT SLAVING ZONES	5-7
5.7 PURGE SEQUENCE	5-8
5.7.1 MECHANICAL	5-8
5.7.2 CHEMICAL	5-8
5.7.3 PRESET PURGE PARAMETERS	5-9
5.8 CHECKING ZONE SETTINGS	5-11
5.9 CHECKING ZONE PAST PERFORMANCE (GRAPH)	5-12
5.10 ALARMS	5-14
5.10.1 MODE WINDOW	5-14
5.10.2 STATUS WINDOW	5-15
5.10.3 IDENTIFYING ZONE ALARMS	5-15
5.10.4 BEACON AND SOUNDER EXTENSION	5-16
5.11 CARD INDICATORS	5-16
5.12 TRAINING AND DEMONSTRATION MODE	5-17
5.12.1 ABOUT DEMO MODE	5-17
5.12.2 SELECT DEMO MODE	5-17
5.12.3 DE-SELECT DEMO MODE	5-18
5.13 USE THE TOOL STORE PAGE	5-19
5.14 CREATE A NEW TOOL	5-20
5.15 RENAME AN EXISTING TOOL	5-22
5.16 LOAD TOOL SETTINGS (LOCALLY)	5-23
5.17 SAVE TOOL SETTINGS (REMOTELY)	5-24
5.17.1 OVER-WRITE THE LAST SETTINGS WITH NEW SAVED SETTINGS	5-24
5.17.2 SAVING NEW SETTINGS, WITHOUT LOSING EXISTING ONES	6-25
5.18 DELETE A TOOL	5-26
5.19 BACK-UP TOOL SETTINGS	5-27
5.19.1 TO SAVE (BACKUP) ALL THE TOOLS	5-27
5.19.2 TO SAVE(BACKUP) ONE SELECTED TOOL SETTING	5-28
5.20 RESTORE TOOL SETTINGS	5-29
5.20.1 TO RESTORE ALL THE TOOLS	5-29
5.20.2 TO RESTORE A SINGLE TOOL	5-30

5.21 QCIO - 4-CHANNEL INPUT/OUTPUT CARD	5-31
5.21.1 INPUTS.....	5-31
5.21.2 OUTPUTS.....	5-32
5.21.3 DEFAULT INPUT/OUTPUT SELECTION AND CONNECTOR PIN TABLE	5-33

Section 6 - Maintenance.....6-1

6.1 PRINT OUT FACILITY	6-2
6.2 EXPORT FACILITY	6-3
6.3 CHECKING TOUCH SCREEN ALIGNMENT	6-5
6.4 SELF DIAGNOSTIC TESTS.....	6-6
6.4.1 WHY YOU MAY NEED TO CHANGE YOUR TEST PARAMETERS	6-6
6.5 RUNNING A SELF DIAGNOSIS TEST	6-7
6.6 SYSTEM DIAGNOSIS RESULTS.....	6-9
6.6.1 INTERPRETING THE TEST RESULTS	6-9
6.7 SERVICE AND REPAIR YOUR CONTROLLER	6-10
6.7.1 REPLACEMENT PARTS	6-10
6.7.2 CLEANING AND INSPECTION	6-10
6.8 SOFTWARE UPGRADE.....	6-11
6.8.1 PREPARATION	6-11
6.8.2 PROCEDURE.....	6-11

Section 7 - Troubleshooting7-1

7.1 FAULT AND WARNING MESSAGES	7-1
7.2 SYSTEM WARNING MESSAGES	7-4
7.3 INDIVIDUAL CONTROLLER CARD DIAGNOSTICS	7-4
7.4 OTHER PROBLEMS WITH THE TOOL	7-5
7.5 FUSES AND OVERCURRENT PROTECTION	7-7
7.5.1 REPLACEMENT FUSES.....	7-7
7.5.2 SUPPLEMENTARY FUSES	7-7

Appendix A - HRC Wiring Details.....A-1

Indexi

Section 1 - Introduction

1.1 Intended Use

This manual is intended for use with the Smart Series TSP Plus-Series Controller together with the MTS Console

Hot Runner Controllers such as this TSP Plus have been designed as a multi channel temperature controller for use in Hot Runner plastic molding equipment. They use feedback from thermocouples within the nozzles and manifolds to give precise closed-loop temperature control.

Any other uses would fall outside the engineered intent of this machine which may be a safety hazard and would void any and all warranties.

This manual is designed to cover most system common configurations. If you need additional information specific to your system please contact your representative.

1.2 Audience

This manual is written for use by skilled persons who are familiar with Hot Runner Controllers and their terminology.

1.3 Required User Skills

Operators should be familiar with plastic injection molding machines and the controls of such equipment.

Maintenance persons should have sufficient understanding of electrical safety to appreciate the dangers of 3-phase supplies. They should know how to take appropriate measures to avoid any danger from electrical supplies.

BEFORE YOU OPERATE THE CONTROLLER

We recommend that you read the manual fully before connecting up or using the controller.

We recommend that you run a Self Diagnostic routine (page 6-7) to check that all zones are correctly sequenced and that there is no cross-wiring between zones or between heater outputs and thermocouple inputs.

1.4 Release Details

Document Id	Release Date	Version
ITSP12.22.15v1	October 2014	3

Our policy is one of continuous improvement and we reserve the right to alter product specifications at any time without giving notice.

Section 2 - Safety Instructions

The SSTSP Plus Controller is an electrical distribution and control device which is designed to be safe during normal operation.



WARNING - HIGH VOLTAGE

It is essential that the user DOES NOT open the cabinet without first ISOLATING the mains supplies to the equipment - there may be terminals inside the cabinet which may have a dangerous potential across them.

Where a three-phase supply is used then this potential may be at 380 volts or higher.

2.1 Safety Notices - an Explanation



WARNING - HIGH VOLTAGE

A WARNING symbol and message, shown here, identifies where there may be a hazardous situation which, if not avoided, may result in death or injury to personnel.

All such warnings pertain to electrical aspects and you must comply with them to minimise any personal danger.



CAUTION

A CAUTION identifies where there may be a hazardous situation which, if not avoided, may result in damage to property.

Caution warnings present no personal danger, but may cause the equipment to fail or lose its memory.

2.2 Where to Use This Equipment

The display console and controller cabinet together are designed for use in the plastic injection molding industry as temperature controllers for third party hot runner systems as commonly used in mold tools. They must not be used in residential, commercial or light-industrial environments. Furthermore, they must not be used in an explosive atmosphere, or where there is a possibility of such an atmosphere developing.

The HRC cabinet and Touch Screen console should be installed in a clean dry environment where the ambient conditions do not exceed the following limits:

- Temperature 0 to +35°C.
- Relative Humidity 90% (non-condensing)

2.3 Check Your Wiring

Before you energise the system, pay special attention to how the supply to your controller is wired and how it is connected to the mold.

Lack of attention to detail causes errors such as:

- Incorrect wiring of mains supply phases into the controller.
- Crossing heater supply feeds with thermocouple detection In such cases wiring errors have caused equipment failure.

DME Company LLC cannot be responsible for damage caused to the controller by customer wiring and/or connection errors.

Section 3 - Overview

3.1 Specification

The following are general specifications. The actual controller/console supplied may have contractual variations and differ in some specified options.

Supply Voltage	415 Volts 3 -phase 50/60 Hz with neutral. Other available include 240/380/400 and 480 volts in Star or Delta configuration.
Voltage Bandwidth	Stable within (20% supply voltage swing)
Supply earth-leakage trip	300mA (note: this is for tool protection)
Overload protection	Miniature Circuit Breaker
Mains Voltage output pattern	Burst-fired with zero voltage crossover
Output overload protection	High-speed semiconductor fuse links
Temperature control method	Closed-loop (Auto) or open-loop (Manual) with HR Software
Control range	0 - 472 Centigrade (Celsius), 32-881 Fahrenheit
Temperature Scale	Centigrade (Celsius) or Fahrenheit
Printer Output Connector	USB Port
Data Communications	RS-232 serial, DB9 male connector
Alarm Output	Closing Contact Relay 5 Amp max
T/C Tool Connector	Harting type Han A or equivalent
Heater Tool Connector	Harting type Han E or equivalent

3.2 The Controller Cabinet

The power supply to the control cabinet is via a strain-relief mounted cable and plug, and this may be wired in star or delta configuration. (Please check your specifications for details on which style has been configured.) There are normally two types of cables supplied; a thermocouple connection, and a power connection.

Typical wiring details are shown in Appendix A.

An alarm output option is available for extending the alarm, or, perhaps, inhibiting the injection process.

3.2.1 Controller Modules

The controller uses six-zone modules that provide real time temperature control.

Each card has three main components:

- thermocouple input CPU,
- two control CPUs,
- multi-voltage output triacs.

Thermocouple Inputs

The thermocouple inputs have preset responses for both J and K- type thermocouples. The associated console provides means of selecting the sensor type which, in turn, sets the CPU linearization to match the selected thermocouple type.

Central Processor Units (CPUs)

The CPU provides the following facilities:

- closed and open loop control of the zones,
- processes thermocouple and current readings to show on display,
- checks for alarm conditions, including excess current, incorrect thermocouple wiring, zone over temperature condition, low impedance between heater and ground, and generates alarm information for the display screen and alarm relay,
- controls the output power to the on-board triac using a number of self-tuning algorithms

The card requires no analogue calibration and is ready for use once set up from the display console.

Output Triacs

The controller card has six on-board triacs, one for each channel, that are capable of controlling heating loads of up to 16 Amps peak.

3.2.2 Power Supply

The D.C. power supplies for the cards, data communications and an alarm output relay are all provided by a single Power Supply Unit. This is located on top of the upper chassis panel.

3.3 How to Isolate the Controller

The main Power Switch is sufficiently rated to disconnect the total load current during switch On and switch Off. To prevent its operation, during maintenance, you can use a suitably-sized padlock, or similar device, to lock the switch in the Off position.

The main isolator is a rotary switch on the 48 zone controller and just a switched breaker on the smaller 12 & 24 zone controllers.

3.3.1 Switching On

Switching ON the Main Isolator for the controller energizes the cabinet and also the console which automatically starts its boot-up sequence.

Once the display screen is showing it may, or may not, start to heat up the zones; it depends on how the Console-Startup option is configured. (See page 4-21.)

If Console startup is set to “Stop” then the tool remains at zero power and at room temperature. If it set to any of the other three options (Startup, Standby, or Run) the controller applies power to the zones so that they heat up.

3.3.2 Switching Off (or Shutting Down)

We recommend that you use the console to shut down the heating load, and only use the main rotary isolator (48 zone) or the breaker switch (12 & 24 zone) to switch off a dormant controller.

1. Shut down the heating

On the main page, choose [Stop] mode to reduce the heating to zero.



2. Shut down the Console

On the Utils page, choose [Exit] to shut down the Console Computer.

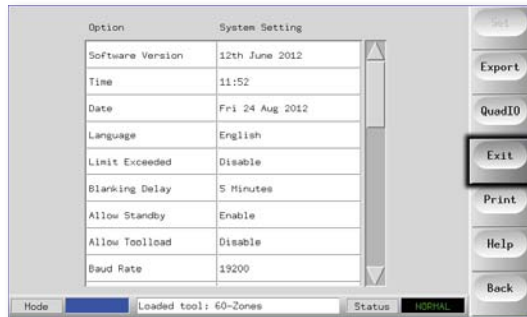

3. Shut down the Controller

Finally, use the main power switch to isolate all the power to the whole system.

On the 48 zone use the rotary isolator..



On the smaller 12 or 24 zone controllers use the breaker switch.



3.4 Screen Layout & Navigation

Control

Side command buttons that change from page to page.



Navigation

The main page has a [Menu] button at the bottom of the side buttons that activates the navigation screen.

All other pages use the [Back] button on the sidebar to return to the main page.



Monitor & Information

The bottom row shows overall information. Reading left to right this includes:

- the current Run Mode
- a message bar
- the current Health status







3.5 Main Page

Can be used for:

- Monitor – observe zone condition.
- Control – Start/Stop & Boost/Standby immediately available. All other (“Standby, Shutdown, Stop”) available from [Mode] button.
- Set – select any one or more zones to get [Set] function to set or alter zone setpoints or run modes.

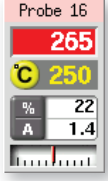
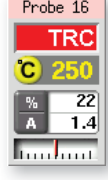
3.5.1 Monitoring

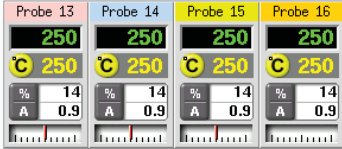
<p>Healthy Zone which shows</p> <p>Zone Name (Alias) _____</p> <p>Actual Temperature _____</p> <p>Scale + Set Temperature _____</p> <p>Percentage Power _____</p> <p>Flow Current _____</p> <p>Deviation for Set temperature _____</p>		<p>Actual temperature is green text on black background</p>
<p>Warning Zone</p> <p>Deviation exceeds 1st stage (Warning).</p>		<p>Actual temperature is black text on a yellow background</p>
<p>Alarm Zone</p> <p>Deviation exceeds 2nd stage (Alarm).</p>		<p>Actual temperature is white text on red background</p>
<p>Fatal Error</p> <p>Problem detected. (See page 7-1 for a list of possible error messages explained.)</p>		<p>Error message reads as white text on red Background</p>
<p>Zone Off</p> <p>Individual zone switched off.</p>		
<p>Different header colors</p> <p>User-configurable colors.</p>		

3.6 Main Page – Display Options

1. Choose [Display] button to show the following options.



2. Touch it once more to show 40 Zones - each zone shows name, actual temperature and set temperature.



3. Touch again to show 60 Zones - each zone shows name and actual temperature.



4. The last touch shows the Data page which displays the SetUp and data for all the zones.
A fixed window below the scrolling pane displays the total current and total power.



3.7 Main Page - Start, Stop & More Options

Button 1 - Can appear as [Run/Stop] or [Startup/Shutdown].



Button 2 - is [Mode].



Choose [Mode] to reveal all other run-mode options.



3.8 Main Page – Setting Temperature

1. Choose one zone.



2. Choose another.



3. Choose [Range].



Setting Temperature - cont.

4. Choose **[Set]** (Password required).

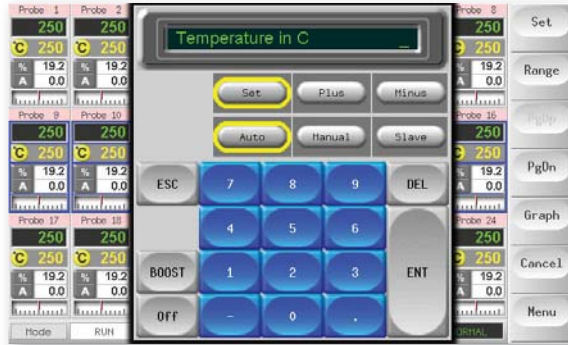

5. Use the **[Mode]** bar to set zone in any of three modes:

- Auto (Closed-loop mode)
- Manual (Open-loop mode)
- or Slave (to another zone)

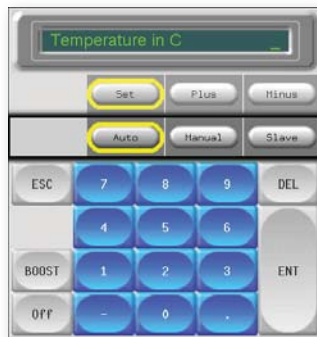

6. Finally use the **[Value]** bar to Set, Raise or Lower temperatures, then set the required temperature and choose **[Ent]**.



3.9 More Pages

The ToolStore page is a tool bank in which you can store up to 20 tool configurations.



The Diagnose page allows you to test zones and/or perform wiring checks on new or recently maintained system.

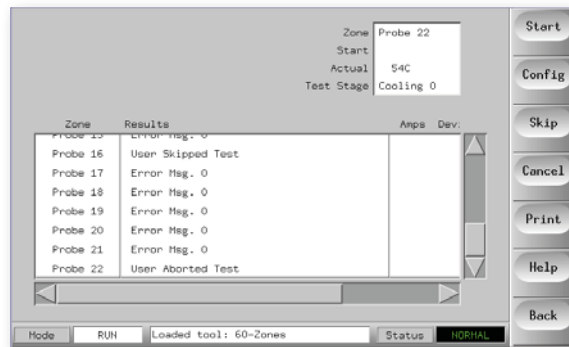

The Utilities page gives access to a few different features:

- an **[Exit]** button to shut down the system.
- a **[Config]** button to SetUp system parameters. (See more on page 4-5.)
- an **[Export]** function and **[QuadIO]** button. (See page 6-3 and page 5-31 respectively for more detail.)

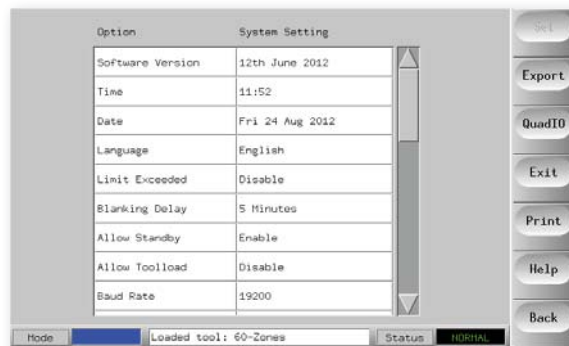

More Pages - cont.

The Setup Page allows you to Setup and configure various Global and specific Tool Parameters.

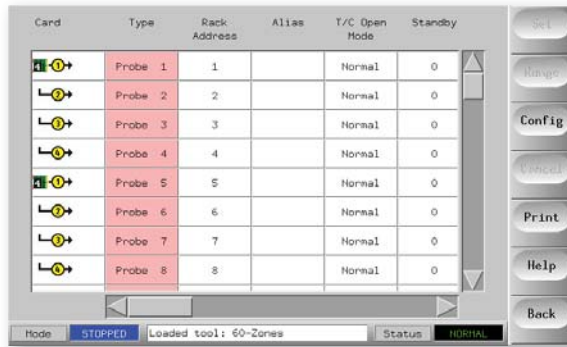

The screenshot shows a control interface with a table of probe configurations. The table has columns for Card, Type, Rack Address, Alias, T/C Open Mode, and Standby. There are 8 rows, each representing a probe. To the right of the table is a vertical stack of buttons: Set, Home, Config, Cancel, Print, Help, and Back. At the bottom, there is a status bar with fields for Mode (STOPPED), Loaded tool (60-Zones), and Status (NORMAL).

Card	Type	Rack Address	Alias	T/C Open Mode	Standby
1-0	Probe 1	1		Normal	0
1-0	Probe 2	2		Normal	0
1-0	Probe 3	3		Normal	0
1-0	Probe 4	4		Normal	0
1-0	Probe 5	5		Normal	0
1-0	Probe 6	6		Normal	0
1-0	Probe 7	7		Normal	0
1-0	Probe 8	8		Normal	0

Mode: STOPPED Loaded tool: 60-Zones Status: NORMAL

The Help Pages which offer some user help.

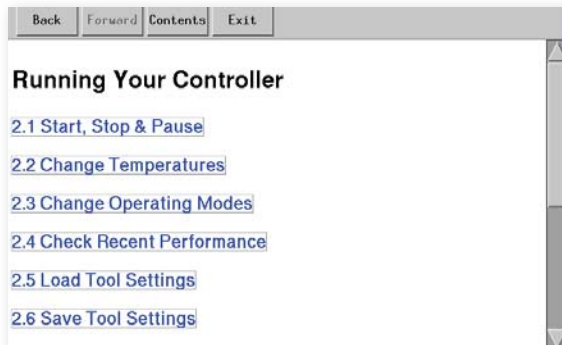

The screenshot shows a help page with a navigation bar at the top containing buttons for Back, Forward, Contents, and Exit. The main content area is titled "Running Your Controller" and contains a list of sub-topics, each with a blue underlined link.

Navigation
Back
Forward
Contents
Exit

Running Your Controller

- [2.1 Start, Stop & Pause](#)
- [2.2 Change Temperatures](#)
- [2.3 Change Operating Modes](#)
- [2.4 Check Recent Performance](#)
- [2.5 Load Tool Settings](#)
- [2.6 Save Tool Settings](#)

3.10 The User Interface

Where the configuration of parameters requires a user interface then either a keyboard or a keypad is displayed.

Keyboard - for Alpha-numeric input.



Keypad 1 - A basic numeric input.



Keypad 2 - Is an extended keypad which adds:
Value keys – Set, Temp, Add and Subtract to set Temperatures.
Mode keys – Auto, Manual and Slave to set working Mode.



Keypads – 3 & 4 - Offers more buttons to select and configure synchro, or spear tips.

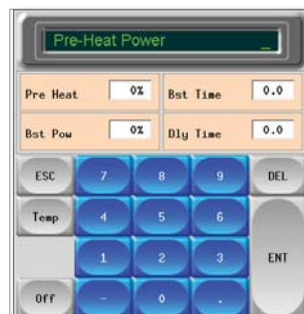
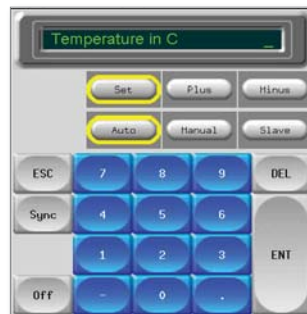

Section 4 - SetUp

New Touch Screen consoles and controllers are provisionally configured at the factory and you may not need this section for a new system.

However, if you need to match a Touch Screen console to a new tool or environment then you should use this section of the manual and work through the four main stages which are briefly described below.

Subsequent pages within “Setting Up” section give a more detailed explanation of each.

What is included in this section

How to create a first tool

How to configure the control cards

Setting the tool parameters (on the SetUp page such as Standby , Boost, Alarm Levels, etc.)

Setting the global parameters (config. values on the SetUp page such as Input Signal, Startup Mode, Console Language, etc.)

Setting the operating parameters (zone temperatures etc. that are set on the main page)

Saving all to a tool bank slot

Setting other Utility page functions (such as Passwords, Printing, etc.)

4.1 Stages Included in Setting up a Console

4.1.1 Create a First Tool

This starts at the Tool Page where a [**Detect**] command interrogates the cabinet to see what various cards are available and then puts that information into the SetUp page.

4.1.2 Set Up Tool Parameters

Once the card information has been written into the SetUp page you then need to look at the displayed cards and allocate a duty to those cards.

It may be that your cabinet is fitted throughout with four-zone 15 Amp cards, but it takes local knowledge to know which zones are nozzles, which are manifolds or bridges and which are sprue bushes. A screen that simply reads zones 1-60 is not as instructive as one that reads nozzles 1-40, manifolds 1-8 etc. Setting your zones to reflect the tool not only makes it easier to use but it will also pre-program control-card characteristics so they are more likely to match the heat load. Even though automatic first time start can do this for you it helps if the cards have some idea of their duty before they are first used.

Once card duty has been allocated then the various tool parameters will take up default values – these may be fine for your general use, but there are many tool parameters (such as warning and alarm levels) which you may wish to fine tune to your particular tool. You should also note that they are all configured on a zone-by-zone basis which can allow you to make precise settings.

Note also, all the values on the SetUp page are stored with the tool setting which is currently selected on the tool page. If you go to the tool page and load a new tool for a different purpose then the new tool may well bring its different setting into this page.

4.1.3 Configure System Settings

The [**Config**] button opens more settings such as startup and boost and tool parameters such as alarms and limits, which are all configured on the SetUp page.

4.1.4 Set up Operating Parameters

Once you have all the above set to your particular system you finally need to go back to the main Display Page and set your main operating temperatures. You can go on to set other values for any monitoring zones that you may have in your console, such as steel temperature, water flow, coolant temperature or other ancillary facilities.

4.2 Create a First Tool

1. Choose **[Menu]** and open the Tool page.



2. Select a blank tool slot and choose **[Detect]**.
3. Enter your System password.



4. Type in a new name for the proposed tool and press **[Enter]**.



5. If no network connected controllers are detected, then it automatically passes this option and goes straight on to step 6. If the tool is connected, via a Network, to any other cabinet, the next step presents an option to select the local controller (labelled "Serial Port") or a remote controller (labelled hrcnetx).



Create a First Tool - cont.

- The console runs an automatic “Card Detect” routine to find out what type and how many cards are fitted in the selected controller. Once it has gathered this information then the console opens the SetUp page for you to start configuring the various Controller Parameters for this new tool.

If the system has any problem running the detect sequence it may report an “Auto Detect Failed” and ask if you want to repeat the Detect routine. If the reason for failure is obvious, such as a loose network cable, or a mains glitch, during the Detect routine, then you may choose [OK] to re-try card detection.

If the detection routine continues to fail then contact your supplier for advice.

4.2.1 SetUp Page - Cards that may be detected

	6-zone card at 16 Amp rating for probes.
	Quad Input/Output card with programmable input and output options.

4.3 How to Configure the Control Cards

The SetUp Grid displays icons in the first column to show what cards have been detected.

Because none of the cards know their function, all temperature control cards initially default to “Probe” zones along with the probe default values (as seen in the first picture).

Although the tool may run on this basic setting it is best that you configure any larger, slower zones such as manifolds etc. Surplus zones should also be set to “Not Used” this time (for instance, if you have six cards offering 36 control zones, but only 32 actual zones, it is best to set the last four zones to **[Not Used]** so they do not display false alarms such as T/C Fail).

Such configuration is detailed in the following steps.

1. Choose the first zone to be configured.

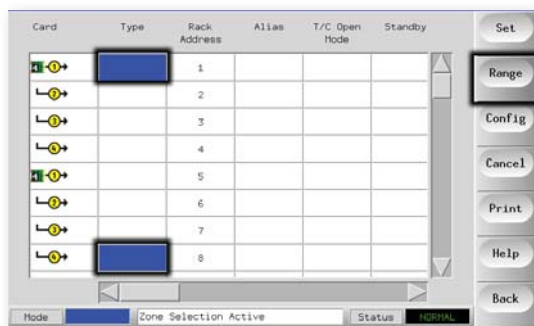

2. Choose the last zone to be configured.

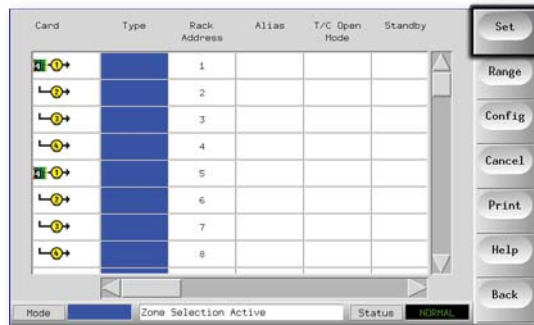

3. Choose **[Range]** to include all those in between.

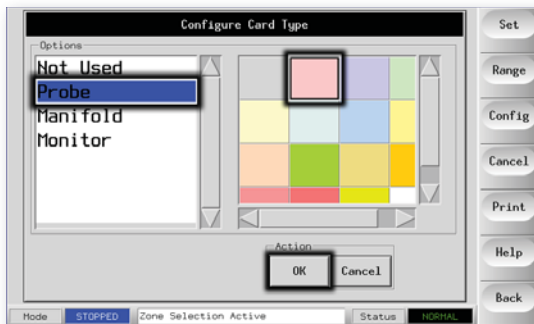

How to Configure the Control Cards - cont.

1. Choose **[Set]** to see the “Configure Card Slot” menu.

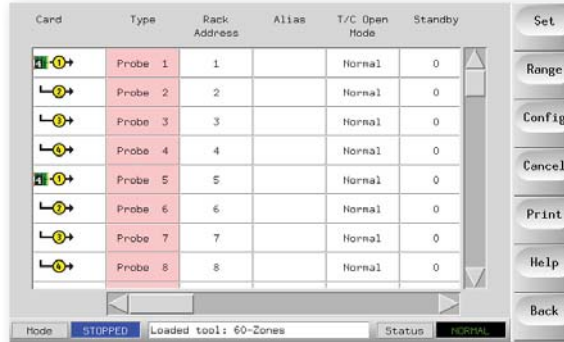

2. Select Zone Type which could be:
 - a. **[Not Used]** is used to switch off unwanted card zones.
 - b. **[Manifold]** - which sets the zone to a slower response curve which suits that sized heater.
 - c. **[Probe]** - which sets the zone to a faster response curve which suits a nozzle heater.
 - d. **[Monitor]** – allows you to set any control zone from any card, as a monitor zone only with no control function.
 - e. **[Special]** - this will be available if Auto-Detect sees that a Quad IO card is fitted.
3. Choose any Header color if the default selection is not required.
4. Choose **[OK]**.
5. Repeat these steps for other types of zones.

4.4 Pre-configured SetUp Values

The table below shows the whole SetUp chart and the differing values that are given to both probe and manifold zones.

Parameter	Probe and Manifold Cards	Other Monitoring Cards	Synchro/Spear
Rack Position	slot address	slot address	slot address
Alias	blank	blank	blank
TC Open Mode	Normal	blank	Normal
Standby & Boost	0°C or 0°F	blank	0°C or 0°F
Master Zone	blank	blank	blank
Warn Hi & Lo	5°C or 9°F	blank	5°C or 9°F
Alarm Hi & Lo	25°C or 45°F	25°C or 45°F	25°C or 45°F
Max Setpoint Setting	350°C or 662°F	350°C or 662°F	350°C or 662°F
Min Setpoint Setting	0°C	blank	0°C
Max Power Setting	80%	blank	80%
T/C Offset Value	0°C or 0°F	blank	0°C or 0°F
Speed	Auto	blank	Auto
Triac	On-Board	blank	Both
Sensor	J-Type	blank	J-Type
Display Group	1	blank	1
Startup Stage	off	off	off
Shutdown Stage	off	off	off
Analogue Input	blank	20 lit/min Flow	blank

If these preset figures are not suitable for the tool in question then you can simply change them to your preferred values by following the next pages.

4.5 Setting the Tool parameters

1. Select the zones.

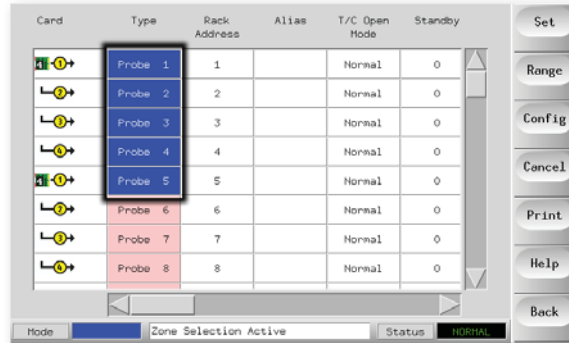

2. Select the parameter.

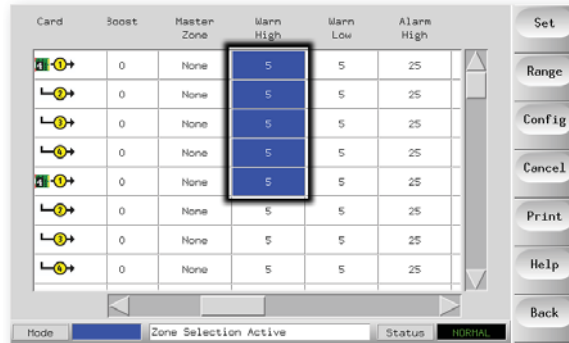

3. Choose [Set].

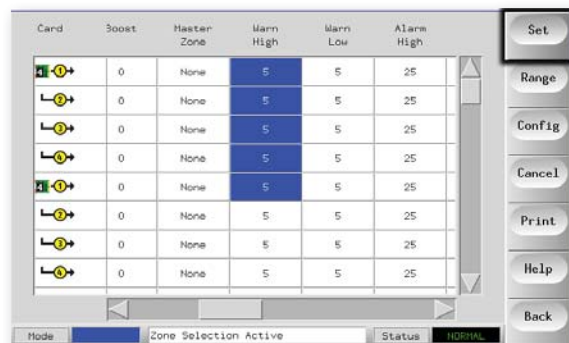

4. Set the Value.



4.6 The Tool Parameters

Function	Description	Setting Limits
Rack Position	Identifies the position of the card within the rack.	This is not user configurable.
Alias	Input for alternative zone names.	Has an auto-increment number facility.
TC Open Mode	<p>Choose a response for any zone that detects a failed thermocouple.</p> <p>Normal – No action corrective taken- the zone power sets down to 0% and it shows a T/C fatal alarm.</p> <p>Auto Manual - The zone has sufficient data, after 10 minutes steady running, to switch to Manual mode at a power level that should hold the previous temperature.</p> <p>Auto Slave – The zone has sufficient data, after 10 minutes steady running, to slave the failed zone to another similar zone.</p> <p>Nominated Zone Slaving – allows you to specify a zone to act as a master to this zone if it were to fail at any time.</p>	
Standby (temperature)	Sets the Standby Temperature for any zone(s).	The maximum Standby temperature is 250°C or 450°F
Boost (temperature)	Sets the boost value for any zone(s)	The maximum Boost value is 250°C or 450°F above the normal set temperature
Master Zone	Select a Master Zone for any groups of sub-zones	Do not select until all zones have been appropriately configured to probes and manifolds etc.
Warning and Alarm Levels	Set the first (Warning) and second (Alarm) stage alarms.	The maximum Warning or Alarm value is 99°C or 178°F.
Alarm Pow	Will generate an Alarm if any average power level, which is measured over the preceding 8 minutes, exceeds this setting.	This defaults to 100% or “Off” so maximum power can be sustained without generating any Power Alarm.

The Tool Parameters - cont.

Function	Description	Setting Limits
Alarms Active	Offers a selection table which allows you to decide how any of the following alarm conditions should affect the system: <ul style="list-style-type: none"> - High Temperature Alarm. - Low Temperature Alarm. - Zone Alarm. - Power Alarm. - Reynolds Number Alarm. 	Option for alarm actions are: Console – which displays the alarm condition in that one panel and Status Panel. Beacon – extends the alarm to activate an attached Alarm Beacon and Sounder. Mold Protect – puts the console to Stop mode. All zone heaters will, as a result, cool down. Injection Disable – sends out a shut down signal from the IO card which may be externally configured to stop the molding machine.
Maximum Set-point Setting	Sets the highest permitted setpoint for the zone(s).	The highest Maximum Setpoint temperature that you can set is 450°C or 850°F.
Minimum Set-point Setting	Sets the lowest permitted setpoint for the zone(s).	The lowest Minimum Setpoint temperature that you can set is 0°C or 0°F.
Maximum Power Setting	Sets the highest permitted power level for the zone(s).	The highest Maximum Power Setting that you can set is 100% power.
T/C Offset Value	Sets a proportional offset between measured and displayed temperature – to compensate for a probe where the T/C may not be sufficiently close to the tip.	The highest T/C Offset temperature is ±75°C or ±135°F.
Speed	Select, or over-ride, the Auto-Speed setting to determine the control characteristic for the zone temperature.	
Sensor	Select temperature sensor for the zone(s) (J or K type).	

The Tool Parameters - cont.

Function	Description	Setting Limits
Display Group	Select groups of zones to display on separate main page. By default all zones are in group 1 but selected zones can be allocated to subsequent groups. Zones that need not be shown on the main page can be allocated to Display Group Zero.	There is a limit of 6 Display Groups.
Startup Stage	Configure groups of zones into discrete Startup Groups.	There is a limit of 6 Startup Groups.
Shutdown Stage	Configure groups of zones into discrete Startup Groups.	There is a limit of 6 Shutdown Groups.

4.7 Configuring the Controller

1. Choose [**Config**] to view the Controller parameters.

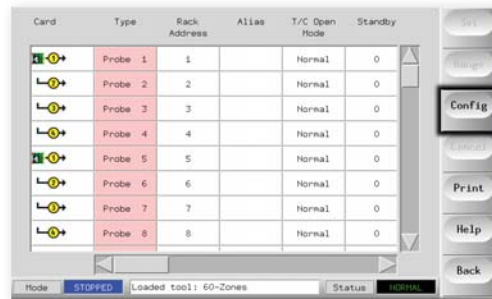

2. The Configure Tool panel lists the various global parameters with a brief description for each. There is also a means of setting that parameter which may vary between value settings (Edit button will bring up a key pad) or simple tick boxes where there may be an either/or choice.

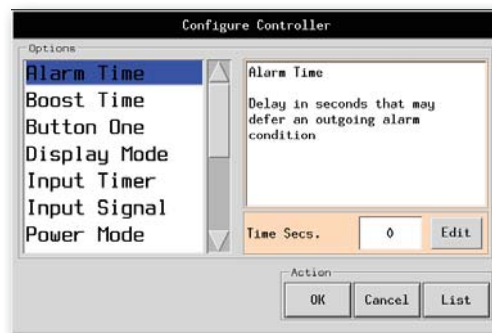

3. For an overview of all these parameters, and how they are currently set, choose the [**List**] button.



4.8 The Global Parameters

Function	Description	Limits
Alarm Time (seconds)	Configure a brief delay between an alarm condition being detected, and an external alarm being sent.	The maximum setting for Alarm Time is 999 seconds
Boost Time	Set the “Boost-Temperature” period.	The maximum period for Boost Time is 999 seconds.
Button One Mode	Set the function of the first mode button on the main page. Choices include paired combinations from choices including Run, Stop, Startup and Shutdown.	
Display Mode	Set the main page and SetUp page to group the zones as: [Sorted] with all Spear zones displayed first followed by probes, then manifolds, then specials. [Mixed] which groups the probe and manifold zones as they are positioned within the card rack, (Manifolds may appear out of sequence order, but grouped with their corresponding probe zones.)	
Input Signal	Set how the console responds to a remote input (normally open pair) at the HAN4A connector on the rear panel: STANDBY - switches the controller into Standby mode when the remote input is closed; and returns to its previous state when the signal is removed. If this option is selected then you can also use the Input Timer option to defer the Standby condition for a preset time. AUTO-STANDBY – this option enables the Input Timer to hold off going to Standby. While a cycling is applied, it resets the timer on each cycle to keep the temperature at normal. If the cycling stops the Input Timer times out and sets the temperature down to its Standby level. STOP - switches the controller into Stop mode when the remote line is closed. If this option is selected then you can also use the Input Timer option to defer the Standby condition for a preset time. AUTO-STOP – this option enables the Input Timer to hold off going to Stop. While a cycling is applied, it resets the timer on each cycle to keep the temperature at normal. If the cycling stops the Input Timer times out then the console goes to STOP. BOOST - this switches the controller into boost mode.	NOTE: 1. The remote input is only effective when the system is in RUN mode. 2. This function defaults to BOOST when the controller has Spear zones. 3. Only those zones that have Boost or Standby temperatures configured in their SetUp will respond to the remote input signal.
Input Timer (minutes) This option is dependent on the Input Signal option.	As a Countdown Timer – If either the Auto Stop or Auto Standby options are chosen then the Input Timer works as a countdown counter which waits for the next cycling pulse. Each cycle-pulse resets the timer so that the console does not go into the Stop or Standby Mode. As a Delay Timer – If either the Stop or Standby options are chosen then this timer starts as soon as the input pulse is received and after this preset time period it switches the console into the selected Stop or Standby mode.	The maximum period for Input Timer is 25 minutes.

The Global Parameters - cont.

Function	Description	Limits
Power Mode	<p>Selects how power levels are shown on the Main page for controllers with normal probes.</p> <p>If you have control cards with current measuring coils this option allows the main page to show either [Current] or Percentage [Power].</p> <p>If there are no current measuring coils then the option should be set to Percent otherwise the Power/Current display will show Zero for controllers with Spear Probes.</p> <p>This decides whether you will see amps or percentage power while a boost signal is received.</p> <p>Choosing [Percent] will allow you to display the percentage power level that is being applied to the Tips during the Boost part of the mold cycle. Outside the boost period each zone displays the percentage power that is being applied to the body only.</p> <p>Selecting [Amps] allows you to see the pre-heat and boost current in the Tips.</p>	
Power Alarm Delay	Allows you to pause the Power Alarm by this many minutes so it does not instantly cause an alarm effect.	Defaults to Zero minutes delay.
Second Startup	<p>Select a final operating mode that the console assumes once it has completed a Startup Sequence and attained normal temperature.</p> <p>[RUN] is default condition.</p> <p>[BOOST] will temporarily assume boost settings until it times out.</p> <p>[STANDBY] will reduce to Standby Temperature until it is manually or remotely changed.</p>	
Standby Temp	<p>Set an overall standby temp which will override individual standby temperature settings that may be configured within the earlier Tool parameters.</p> <p>Leave this set to 0° for individual standby values to remain valid.</p>	Max standby Temp is 260° C
Startup Mode	<p>Select between three different Startup modes ...</p> <p>MASTER-FOLLOW - a default option that ties the faster-acting nozzles' set temperature to slower manifold's actual temperature. This produces a homogenous rise with all zone temperatures coming up together.</p> <p>MASTER-ONLY –heats only the nominated Master zones first - it does not apply any power to the subordinate nozzles until the Master zones have reached their set temperature.</p> <p>STAGED – allows you to nominate up to eight stage groups that will heat up in successive stages.</p> <p>When Staged Startup is selected then the shutdown automatically follows a staged shutdown. Note, however, that there is a separate allocation for shutdown groups – so a shutdown pattern need not be the same as the startup sequence.</p>	

The Global Parameters - cont.

Function	Description	Limits
Shutdown Timer	Set a delay period to hold on successive groups during a Staged Shutdown. It sets, in minutes, the time that successive zone groups must wait before each switches off. Setting this option to zero makes the timer ineffective so that Staged shutdown is reliable solely on Shutdown temperature.	The maximum period for Shutdown Timer is 99 minutes.
Shutdown Temperature	Sets the temperature to which each Shutdown group must fall before the next group is switched off. Raising the shutdown Temperature means that zones do not have to cool down so much until subsequent stages are switched off which shortens the overall shutdown time. Lowering the Shutdown Temperature has the opposite effect and lengthens the shutdown time.	The Shutdown Temperature setting defaults to "0" which represents an extremely long shutdown interval. The highest shutdown temperature permitted is 260°C or 500°F and if this set value is equal to, or higher than, the normal temperature, then it has no effect and the shutdown interval becomes dependant on the Shutdown timer.
Temp Scale	Choose [Degree C] or [Degree F] as required.	

Finished Configuration?

Once you have completed all the necessary configuration boxes, and want to save them, as they have been set, choose the [**OK**] button. If you do not wish to accept the changes made, choose [**Cancel**]. The configure menu disappears, and the system reverts back to any previous selections that may have been made.

4.9 Setting Operating Parameters

Selecting Zones

1. Choose the First zone.



2. Choose the Last Zone.



3. Choose [Range].



Setting Operating Parameters - cont.

4. Choose [Set].

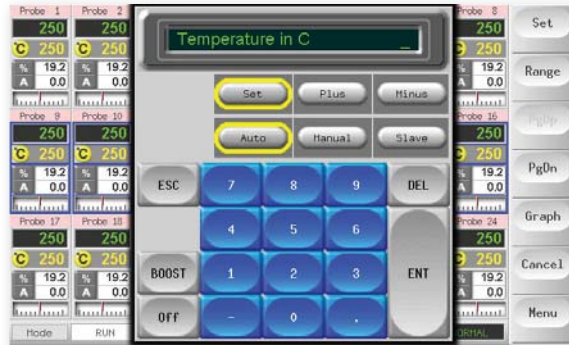

5. Set the Value.



6. Choose [Enter] to confirm your settings (or [Esc] to return to the main page without accepting the new choice and values).

4.10 Set Probe and Manifold Temperatures

1. Choose **[Set]**.



2. Choose **[Auto]**.

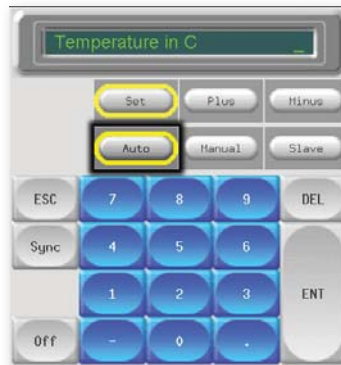

3. Set the Temperature Value or choose **[Delete]** to undo any last entered figure.

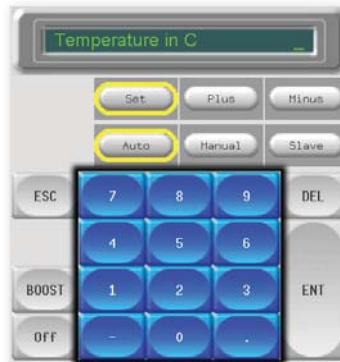

4. Choose **[Enter]** to confirm your settings or **[Esc]** to return to the main page without accepting the new choice and values.



4.11 Saving Everything to a Tool Bank

1. Select the Tool store page.



2. Select the new tool named earlier. (See page 4-3.)

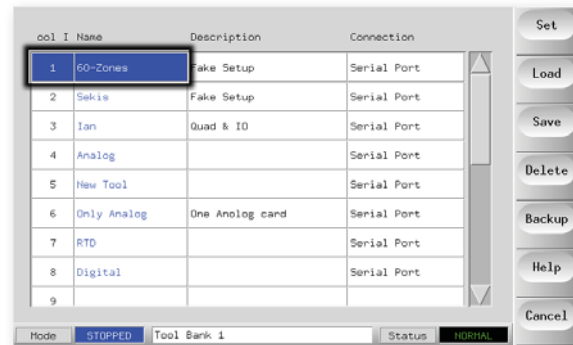

3. Choose [Save].



4.12 Setting Up Other Utilities

The Utilities screen gives you access to several user-configurable parameters. The only exception, however, is the first piece of information which is the current Software version. This always shows the version date and it is automatically reconfigured if ever the software is upgraded. It is helpful if you make a note of the Software version date before you contact your supplier with any technical query.

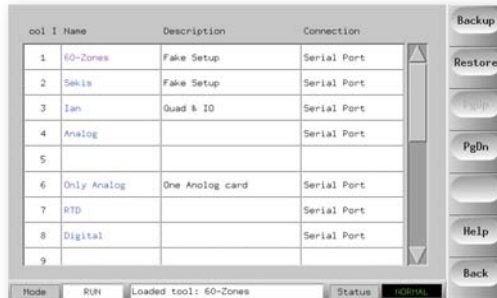

All the following parameters are found within the Utilities page:

Function	Description	Notes
Software Version	Shows which version of the software is installed.	Not user-configurable.
Time	Set the correct time and date, so that any hard copies of Tool Test. or Export Data will be correctly marked up when printed out.	
Date		
Language	Select any available language for the screen text.	After selecting a different language, the console will temporarily shut down and restart in the new selected language. If the system is in RUN mode then the Control cards will maintain the working temperatures during this brief change over.
Limit Exceeded	<p>[Disabled] – means that an attempt to set the temperature above the limit is non-effective and the Set temperature stays the same.</p> <p>[Enabled] – means that an attempt to raise the Set temperature above the limit will increase the set temperature to the limit and no more.</p>	
Blanking Delay	Set how long the screen remains visible.	Blanking Delay Set how long the screen remains visible The maximum period for Blanking Delay is 98 minutes. You can override the Blanking Delay so that it remains permanently visible by setting this time to “99 minutes”.

Setting Up Other Utilities - cont.

Function	Description	Notes
Allow Standby	If set to [Enable] then you can switch the console into Standby Mode from any other operating mode. If set to [Disable] you cannot switch from Stop mode into Standby. Instead you must first put the console into a run or start mode before Standby Mode is available.	
Allow Tool-Load	Select [Enabled] if you want to be able to change tools while in Run mode, or [Disabled] if you wish to prevent such changes and force the operator to shut down to swap tools.	If ToolLoad is disabled then the [Load] button on the ToolStore page is greyed-out while the system is in RUN mode.
Baud Rate	Set the communication rate between the Console and the control cards. Later cards can work at [High] speed while older cards might require [Low] speed.	
Console Startup	Select the operating mode that is assumed after initial switch on.	
N/Z Alarm	[Disabled] – leaves N/Z in its normal condition which does not raise a system alarm if it occurs. [Enabled] – allows N/Z condition to initiate a System alarm notification in the lower status Window. At the same time it energizes the Alarm Relay for remote signaling.	
Temperature Precision	Allows you to set the resolution for the Actual temperature seen on the Display Page to a floating point scale which displays temperature to within one tenth of a degree or an integer scale which rounds the displayed temperature to the nearest whole degree. Select [Float] or [Integer] as appropriate.	
Printer	Select your connected printer from a stored list.	See “Configuring a Printer” on page 4-26 for more details.
Printer Address	Select a local connected or network connected printer.	
Paper Size	Select A4 or Letter sized printer paper	
Machine Name	Used by IT staff to set the networking configuration to work with a Network.	For more details consult your supplier.
Domain Name		
IP Address		
Net Mask		
Obtain Address SPI Interface		

Setting Up Other Utilities - cont.

Function	Description	Notes
User Password	<p>If this is set to [Enabled] then all password-protected functions need either a User (Level 1) or System (Level 2) authorisation as shown by the Password Application table on page 4-24.</p> <p>If User Password is set to [Disabled] then all the lower functions become available without the need for any password. Only those higher functions that require a System (Level 2) password retain their Password protection.</p>	
Edit User Password	Set the Level 1 password.	See “Controlled access through Passwords” on page 4-23 for more details.
Edit Syst(em) Password	Set the Level 2 Password.	
Password Timer	Set the Password-Active timer.	
Calibrate Touch	Set the screen response to align with point of touch.	See “Calibrating the screen” on page 6-5 for more details.
Protocol Installed	Shows the Protocol which is currently installed and which will be used to communicate with remote terminal.	Defaults to SPI and is not user-configurable. However it can be set to Kistler protocol if requested when ordered.
Protocol Address	Enter an address for the console when it needs to communicate via an external protocol.	
Power Display	[Peak] option shows the peak amps delivered [Derived] modifies the peak power by the percentage time for which it is switched on and so will usually read less than peak.	
Supply Voltage	Enter the System Supply Voltage; It is used to calculate the “Watts” display. This is normally the phase-neutral voltage on a star supply and the phase-phase voltage on a delta supply.	Maximum supplied Voltage is 400V.

4.13 Password Options

When you first use your TouchScreen controller you find, as you go through some pages, that some functions are protected by password access. Wherever a password is required then a prompt in the message window at the bottom of the screen indicates whether the particular function requires a User or a System password.

4.13.1 Three Levels of Control

If the User Password option is set to [**Enabled**] then there are three levels of control:

1. Open Level - includes various functions that need no password such as Start and Stop.
2. User is a Level 1 password which gives low level access to:
 - switch the tool on and off.
 - alter temperatures.
 - select different tools.
3. System is a Level 2 password which gives high-level access to:
 - all user-level functions.
 - set the user password.
 - re-configure the settings for a new tool.
 - Store and load new tool settings to/from the disc.

4.13.2 Two Levels of Control

If the User Password option is set to [**Disabled**] then all those functions that would normally need a User/Level 1 Password become Open Level and no longer require any Password to access. Only those higher functions that require a System/Level 2 password retain their Password protection.

4.13.3 About Password Active Times

After you key in a password, access is possible while you continue to input data. Each key-touch resets the timer but, when no more input is detected, it times out and then denies unauthorized access. This is the same for both User/Level 1 and System/Level 2 passwords.

If, while the System password is active, you visit a lower level page that only requires User/Level 1 password level (e.g. Main) or none at all (e.g. Graph) then the System password will expire after 20 seconds but, on doing so, it becomes a User/Level 1 password which would allow you to continue setting lower level parameters.

4.13.4 Password Application Table

Here is a detailed list of what level of password is required for various functions on the different pages.

Page/ Screen	No Password required to	Level 1 (User) password required to:	Level 2 (System) password required to:
Main	Run/Stop/Change Modes. Change Display options. Go to Zoom or Graph page	Set (Alter temperatures or modes)	
Zoom		Set (Alter temperatures or modes)	
Graph	View/Keys/Print		
Tools	Export/ Exit (shut down console)	Load, Save, Backup Restore, Delete	New (Create new tools)
Utils	Set/Change Time		Change any Utility Values
SetUp			Set, Config (Change any values)

4.13.5 Password Security

Every machine leaves our factory with two levels of password protection (these are provided on a detachable page at the front of the Manual). We recommend that you change these, as soon as possible, to establish your own security.

4.13.6 Edit System Password

1. Choose [**Menu**] and open the Utils page.
2. Choose [**Edit System Password**].
3. Choose [**Set**].
4. First establish your authority by entering the System password.
5. Next, enter your new System password.
6. Re-enter your new System password to confirm it.
7. Choose [**Back**] to return to the Main Screen.

4.13.7 Edit User Password

1. Choose [**Menu**] and open the Utilities screen.
2. Choose [**Edit User Password**].
3. Choose [**Set**].
4. First establish your authority by entering the System password.
5. Next enter you new User password.
6. Re-enter the new User password to confirm it.
7. Choose [**Back**] to return to the main page.

4.13.8 Setting Your Password Timer

1. Choose [**Menu**] and open the Utils page.
2. Choose [**Password Timer**].
3. Choose [**Set**].
4. If required, type in your System password at the next prompt.
5. In the following keypad touch-type your required password active time (in minutes) and then [**Enter**].
6. Choose [**Back**] to return to the main page.

4.13.9 Password Override

To override the User and System Password control, set the Password Timer to "99". This setting negates the need to enter a Password at any of the usual checkpoints such as Load Tool or Temperature Change. Under this condition, the only function that still needs a Password input is the Change Password action.

4.14 Configuring a Printer

4.14.1 Using the USB Socket for a Local Printer

1. Choose [**Menu**] and open the Utils page.
2. Choose [**Printer**].
3. Choose [**Set**].

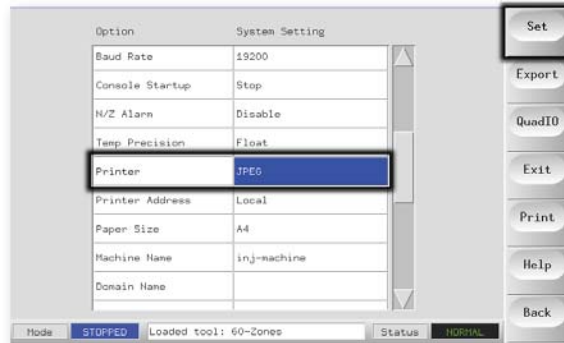

4. In the panel that appears scroll down to find a suitable printer driver (A brief description of the printers catered for by that selection is displayed in the adjacent window).
5. Choose [**Local**] for your printer connection then [**OK**].
6. Choose [**Paper Size**].
7. Choose [**Set**] to see the Paper-size selection panel.
8. Choose [**A4**] or [**Letter**] and choose [**OK**].
9. Choose [**Back**] to return to the main page.

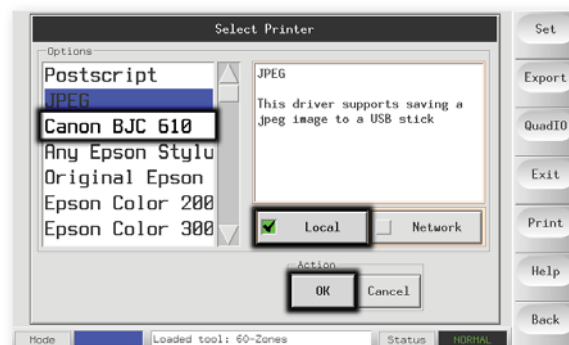

4.15 More Utilities Function Buttons

4.15.1 Export

Exports historical performance data.

(See “Export Facility” on page 6-3 for details.)

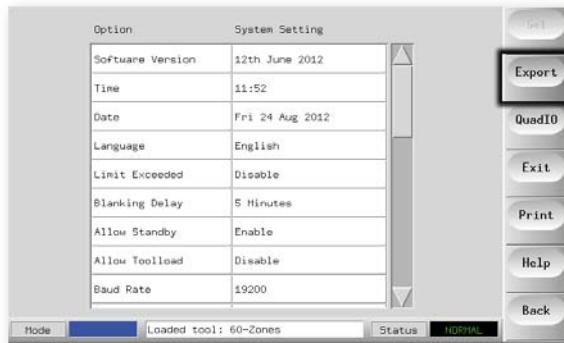

4.15.2 Exit

The correct method to shut down the Console computer is to choose [Exit] and let it power down the console before you turn the main isolator to Off.

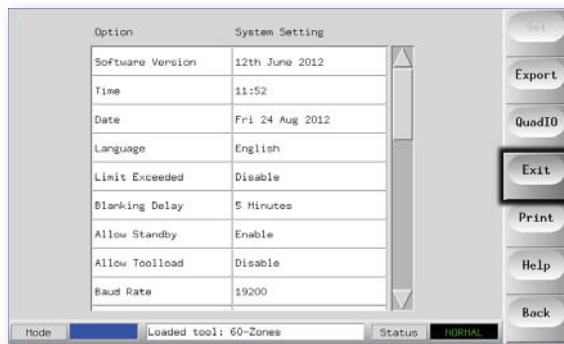

4.15.3 Quad IO

This is a digital Input/Output card that offers up to four separate inputs and outputs to facilitate remote interaction with the controller.

Read how to set the card options on page 5-31.

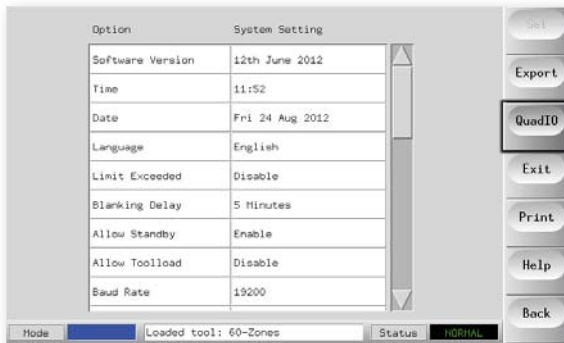

Section 5 - Operation

The Operating section of the manual describes how use the controller. This includes stopping and starting the controller, how to adjust temperatures and settings, and recognise alarms.

It also introduces the extra features which are there to help you ,such as historic logs, and the flexibility offered by using the toolstore page and the IO Card.

What is included in this section

Control modes - Starting, Stopping and more

Using the main page to control and monitor temperatures

Using Slave Mode to compensate for a failed thermocouple

Looking at temperature history for the last 5 to 30 minutes

Alarms - what alarms may be seen on the controller.

Using the ToolStore Page

Renaming an Existing Tool

Loading Tool settings

Saving Tool settings

Deleting a Tool

Backing-up Tool Settings

Restoring tool settings

The Quad I/O Card

5.1 Control Modes for all Zones (from the Main Page)

Operation	Available by	Description
RUN	Button One or Mode Button	Switches on all zones.
STOP	Button One or Mode Button	Switches off all zones. NOTE: Selecting Stop does not remove voltage from the heaters; it switches off by setting all the target temperatures to Zero. Do NOT try to change fuses or disconnect units while in this mode.
STANDBY	Mode Button	Reduces the temperature of all zones that have any Standby Temperature configured on the SetUp page. Temperature remains reduced until RUN command is given.
STARTUP	Button One or Mode Button	<p>FIRST STARTUP</p> <p>Initiates a starting sequence that is configured on the SetUp Page.</p> <p>MASTER-FOLLOW – Applies power to Master zones then adjusts other zones' Set Temp to follow Master Zones' Actual Temperature – produces a homogenous heat rise.</p> <p>MASTER-ONLY – applies power to Master Zones but waits until they are at full temperature before switching on all others.</p> <p>STAGED – applies power to nominated stage zones and then waits until they reach normal temperature before switching on next stage zones. This cascades the startup sequence through several stages.</p> <p>SECOND STARTUP</p> <p>When all the zones have reached their set temperatures the system then goes into SECOND STARTUP mode which may be configured to either:</p> <p>RUN – maintain their Set Temperature.</p> <p>BOOST – temporarily raise the temperature and then settle back to normal Set Temperature.</p> <p>STANDBY – lower zone temperatures until Run command is given.</p>

Control Modes for all Zones - cont.

Operation	Available by	Description
SHUTDOWN	Button One or Mode Button	<p>Initiates a switch-off sequence that is determined by the startup mode.</p> <p><i>With the Startup Mode set to Master-Follow or Master-Only</i></p> <p>Shutdown switches off the nominated master zones then adjusts all other zones' Set temperatures to the manifold Actual temperatures. The whole tool then cools in a homogeneous manner.</p> <p><i>With the Startup Mode set to Staged</i></p> <p>Shutdown consecutively switches off the zone groups in timed intervals and in the order as nominated by Shutdown Stage configuration.</p> <p>When the Shutdown sequence finishes then the system goes to STOP mode.</p>
BOOST	Mode Button	<p>Temporarily raise the temperature of all zones that have any Boost Temperature configured on the SetUp page.</p> <p>When the boost period expires then zone temperatures return to normal Set levels.</p>
PURGE	Mode Button	<p>This can only be initiated while in RUN mode then, after selecting, it guides your through a typical color change routine.</p>

5.2 Control for Individually Selected Zones

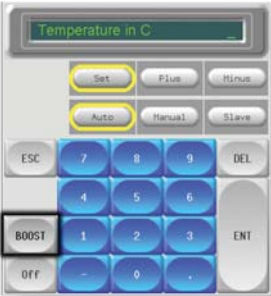
Operation	Available by		Description
STOP	<ol style="list-style-type: none"> 1) Select Zone 2) Choose [Set] 3) On keypad, choose [OFF] 	 <p>The image shows a keypad with a digital display at the top showing 'Temperature in C'. Below the display are buttons for 'Set', 'Plus', and 'Minus'. The next row has 'Auto', 'Manual', and 'Slave'. Below that is a numeric keypad from 0 to 9, with 'ESC' on the left and 'DEL' on the right. At the bottom are 'BOOST' and 'OFF' buttons. In this image, the 'Set' and 'OFF' buttons are highlighted with a yellow border.</p>	Switches off the one zone.
BOOST	<ol style="list-style-type: none"> 1) Select Zone 2) Choose [Set] 3) On keypad, choose [BOOST] 	 <p>The image shows the same keypad as above. In this image, the 'Set' and 'BOOST' buttons are highlighted with a yellow border.</p>	Temporarily raises the temperature of the selected zones until Boost Time expires.

5.3 More about using Boost

Boost mode is determined by two quantities that determine boost – the boost temperature and its time.

Boost Time takes precedence over boost temperature. Once the boost period expires then the extra heating power is removed regardless of whether the zones actually reach the configured Boost temperature.

Boost raises the temperatures of only zones that have any boost temperature configured.

Boost mode is only available while the system is in Run mode

The Boost Command may be received locally through the console interface or remotely via the remote console interface or the Quad I/O Card.

5.3.1 Manual Boost Display

When a Manual Boost command is given, the Mode window shows **BOOST** in black letters on a yellow background. The BOOST message displays until Boost-Time period expires after which the zones returns to normal set temperature and the Mode Window shows RUN.

5.3.2 Remote Boost Display

When a boost Command is received from an external source the Mode window shows M/C BOOST as black letters on a white background. The time that the message displays for is dependent on the external signal.

Brief Signal - If the external signal is brief for example, it lasts 1 second, and the Boost Time is set to something longer, perhaps 3 seconds, then the nozzles are boosted for 3 seconds after which they return to normal level. The M/C BOOST signal is also displayed for 3 seconds after which it returns to RUN.

Long Signal - If the Boost Time is set to 3 seconds and the external signal lasts for 4 seconds, then the nozzles are boosted for 3 seconds and then return to their nominal value. However the M/C BOOST message in the Mode window displays for 4 seconds (while the external signal is present) even though no boost current is being applied for the last second.

5.4 Use Main Page to Change Temperatures

1. Select the desired zones.



2. Choose [Set].

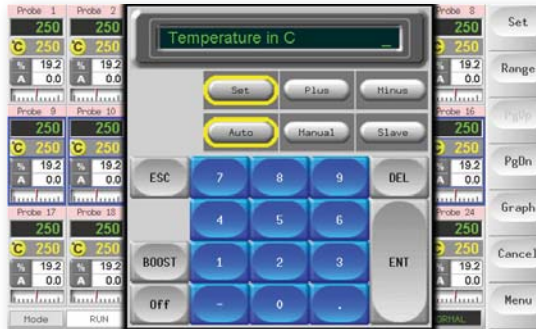

3. And then:

- To Set a new temperature - Choose [Set]
- To Raise the overall temperature - Choose [Plus]
- To Lower the overall temperature - Choose [Minus]



4. Enter the Temperature setting or change.



5. Choose [Enter] to make the setting or [Esc] to defer the action.

5.5 Using the Main Page to Change Modes

1. Select the desired zones, (this automatically changes the function keys from Global to Zone).



2. Choose [Set] to display the keyboard.



3. And then:

- To change to Manual - Choose [Manual]. and set percentage power
- To Slave a zone - Choose [Slave] and select a similar master zone from the Zone list.
- To return to Auto - Choose [Auto] and enter the required zone temperature.



5. Choose [Enter] to make the setting or [Esc] to defer the action.

5.6 More about Slaving Zones

There are several points that you should remember when using zone slaving.

1. **You can only slave like zones to like zones.** - You cannot slave a probe zone to a manifold zone.
2. **You cannot nominate another zone that is already slaved to another.** - If, for example, zone 2 is currently slaved to zone 3, you cannot slave zone 1 to zone 2. The leading zone must already be a healthy zone.
3. **You cannot nominate a zone that creates a loop.** - If, for example, zone 2 is slaved to zone 3, then you cannot slave zone 3 back to zone 2.
4. **When selecting a lead zone to slave to you should find a similar zone type that is currently operating at the same temperature and at the same power level.** - If you nominate a lead zone that is working at the same temperature but outputting a noticeably different power level then the slaved zone may not regulate efficiently.

5.7 Purge Sequence

The purge mode is only available while the tool is in Run Mode and has two different modes:

5.7.1 Mechanical

Mechanical purge is a passive sequence that gives the operator four programmed steps to expel one color and then introduce a new different color.

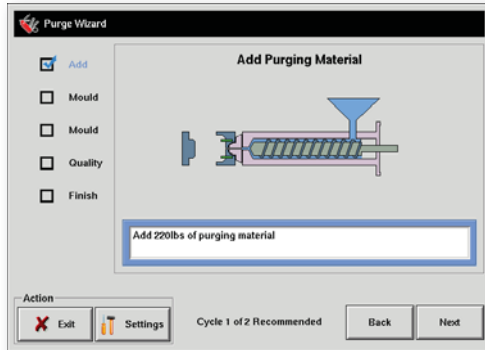

After you select [**Purge**] from the [**Mode**] drop-down, the screen changes and guides you through the four steps. Each step tells you to perform a preset action after which you can choose [**Next**] to move on to the next stage. Eventually it asks whether the quality of the new color is acceptable.

Answering [**No**] takes you back to the beginning to run the sequence again.

Answering [**Yes**] closes the purge screen and returns you to the main Display page.

You may exit the Purge wizard at any time by choosing [**Exit**] at the lower left of the Wizard screen.

5.7.2 Chemical

Chemical purge is a combination of active and passive sequence. It is a preferred sequence to use a proprietary purge agent.

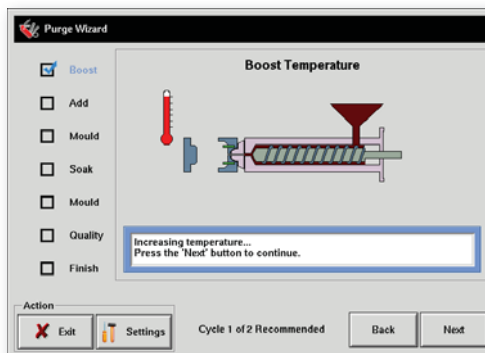

After you select [**Purge**] from the [**Mode**] drop-down, the screen changes and guides you through the seven steps.

It goes to 'Boost' temperature as soon as the purge sequence is started and overrides the normal Boost Time and holds the Boost temperature until you press [**Next**].

The next two steps or 'Add' and 'Mold' are passive and wait until the operator completes each action and chooses [**Next**].

The 'Soak' stage is active and the controller will hold the mold at temperature for at least that preset 'Soak' time during which the [**Next**] and [**Back**] buttons are faded and inoperable. Once the timer expires the operator can choose [**Next**] and continue with the final 'Mold' and quality checks.

You may exit the Purge wizard at any time by choosing [**Exit**] at the lower left of the Wizard screen.

Settings

To configure the Purge parameters you must select Purge which then offers you three choices:

- Enter purge mode.
- Cancel the selection and return to main page.
- Enter the purge Settings page.

This last option gives access to the Purge settings panel with the following parameters.

5.7.3 Preset Purge Parameters

You can also set the Purge Parameters at any time while the Purge Wizard is on the screen. This picture shows the Purge Wizard settings at default value, and they are as follows:

Recommended Cycles – This value is the recommended number of times that the entire purging process is repeated. The recommended cycles is displayed in the bottom left of the purge wizard. Although this value should be followed by the operator, it does not restrict the amount of cycles that can be done. For example if the color is acceptable before the number of recommended cycles are completed the operator has the option to finish the process early based on their discretion.

The maximum setting for Recommended Cycles is 5 cycles - if you find that this seems to be insufficient for your particular tool then please contact your supplier for further advice.

Purge Material – This is the amount of purging material that the operator will be instructed to add to the machine. This value can be entered in either kilograms or pounds. The unit for weight can be changed in the menu that comes up after choosing [**Config**] under the 'SetUp' tab from the main screen. The maximum value that one can enter is 200kg or 440 lbs.

Purge Cycles – 'Purge Cycles' is the number of cycles that the operator is instructed to run using the purging material. This setting is only applicable to the chemical purging process and does not apply to the mechanical process.

The maximum value for this setting is also 1000.

Normal Cycles – ‘Normal Cycles’ is the number of cycles that the operator is instructed to run using the normal production material. The maximum value for this setting is also 1000.

Soak Time (Only available when Chemical Purge is active) – the wait period that you wish for the operator to hold the purge material in the barrel and mold.

The maximum value for this setting is 10 minutes.

Purge Mode – select either Mechanical or Chemical purge sequence

(Note this option is not available if you select [**Settings**] from the Purge Wizard. You may set purge mode if you select [**Settings**] at the pre-run panel.)

Record a Color Purge Cycle

At the end of a satisfactory purge run the Parameters are displayed along with an option to print them out. If you chose not to print then choose [**Exit**] to leave the screen.

5.8 Checking Zone Settings

1. Select any zone.



2. Choose [Zoom].



The top of the page shows the zone name or alias in its appropriate color background, along with live temperature information.

The lower half shows the current SetUp configuration.

[ZoneUp] and [ZoneDn] buttons allow you to browse other zones without returning to the main page.

If the selected zone is a spear type then the extra Tip information is shown at the upper right hand side of the screen as seen here.



5.9 Checking Zone Past Performance (Graph)

Your controller can record temperature history and display a graph of temperature over the last 30 minutes running.

1. Select up to six Zones.



2. Choose [Graph].

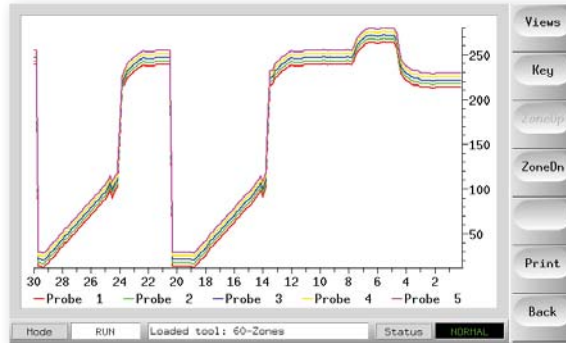

3. Choose [Key] to expand graph size.
(this action loses the bottom Key color information).

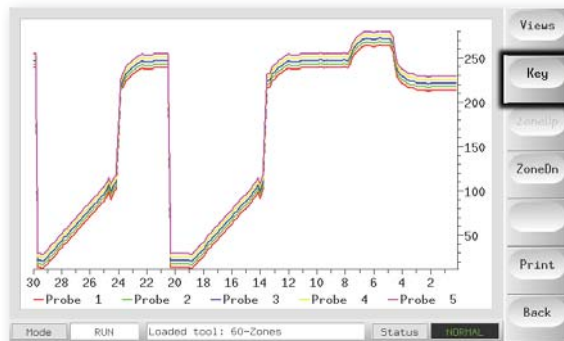

Checking Zone Past Performance - cont.

- To zoom the axes use the [Views] button.

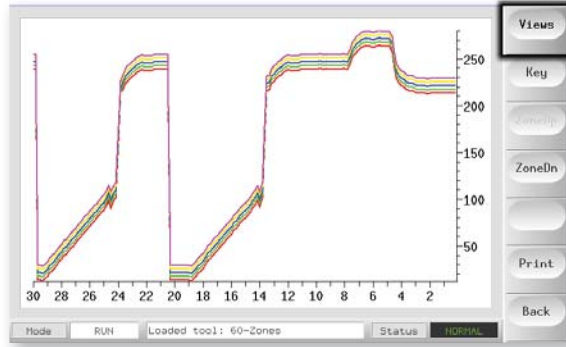

- Use the top four [Zoom] keys to expand time of temperature scales.
Drag either scale to shift the display.

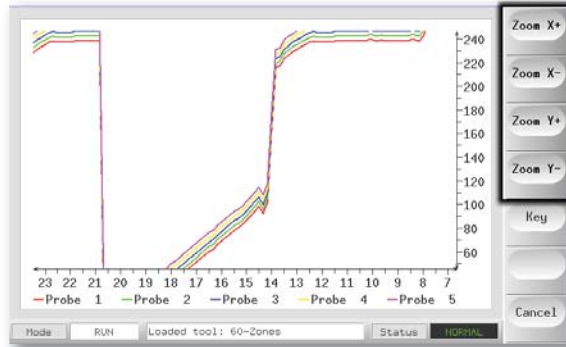

NOTE: Once any Zoom is used then graph freezes in time and does not update.

5.10 Alarms

Whichever page may be active; there is a common Mode and Status window at the bottom of the page.

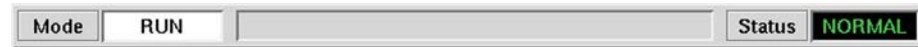

If your controller is switched on and running normally then the left hand Mode window will show RUN and the opposite Status window will show NORMAL.

5.10.1 Mode Window

If the controller is manually switched out of RUN mode then the Mode window shows the selected function, and is seen flashing, on and off.

The table below lists the different displays:

RUN	Black text in White box	All control zones are working normally.
STOP	White text in Blue box	The System has been shut down and the heaters are at room temperature.
STANDBY	Yellow text in Black box	Any zones with Standby Temperatures configured have been reduced in temperature until the next command is given.
STARTUP		The system has been started in a homogenous or staged heat-rise. It will switch to RUN when working temperature has been reached.
SHUTDOWN		The system has been shut down in a homogenous or staged heat fall. It will switch to STOP when room temperature has been reached.
BOOST	Black text in Yellow box	Any zones with Boost Temperatures configured are being temporarily raised. (manual request)
M/C BOOST	Black text in White box	Any zones with Boost Temperatures configured are being temporarily raised. (machine request)
PURGE	Yellow text in Black box	This can only be initiated while in RUN mode and then goes on to guide your through a typical color change routine.

5.10.2 Status Window

The right hand Status window shows NORMAL if all the zones are at their set temperature and no faults have been detected. If any zone detects a fault then the Status window changes its display and color as detailed below:

NORMAL	Green text in Black box	Controller is running normally.
WARNING	Black text in Yellow box	A zone's Temperature exceeds the warning limits.
ALARM	White text in Red box	This shows either a Fatal Error or a zone's temperature exceeds alarm limits.

Note that the status alarm is only active when in Run Mode – so systems, whose temperature rises slowly such as a Master-follow, will not raise spurious alarms. Once they switch over to Run mode at their set temperature then the alarm becomes active.

5.10.3 Identifying Zone alarms

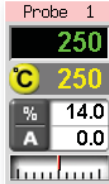
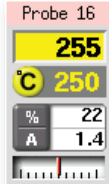
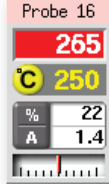
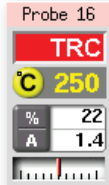
<p>Normal Zone</p> <p>This shows a healthy zone.</p>		<p>The actual temperature is green text on black background</p>
<p>Warning Zone</p> <p>This shows a first stage warning.</p>		<p>The actual temperature is black text on yellow background</p>
<p>Alarm Zone</p> <p>This shows a second stage alarm.</p>		<p>The actual temperature is white text on red background</p>
<p>Fatal Error</p> <p>an abbreviated Error message.</p> <p>(For a list of all Error messages see page 7-1.)</p>		<p>The error message is white text on red background</p>

5.10.4 Beacon and Sounder Extension

A Beacon and Sounder extends any second stage temperature alarm or fatal error alarm. Curing the alarm condition automatically extinguishes the beacon/sounder.

A key switch is also provided to mute the sounder at any time. Note however, that no reminder is given to show that the sounder is muted when the system is healthy. Re-occurrence of subsequent alarm conditions will cause the beacon to light but not create an accompanying audible alarm.

5.11 Card Indicators

Zone Control Cards also have their own LED indicators that give a state-of-health display and which can be seen through the cabinet windows.

SCAN – this LED flashes briefly as the controller interrogates each card in sequence.

FAULT – Should normally be extinguished. It lights to show that one zone on the card has detected an error. The nature of that error is displayed in the particular zone on the console, all of which are listed in the list of Fault and Warning message table listed on page 7-1

5.12 Training and Demonstration Mode

Your controller has a Demo Mode to use for training or demonstration purposes.

While this mode is engaged, the controller will not communicate with the associated Controller Cabinet therefore we recommend that you ensure that the system is idle before using the Demo Mode Facility.

5.12.1 About Demo Mode

Demo mode feeds every zone, within the selected tool, with a stream of pre-recorded temperature data. The Console appears to be working and it gives a real trace when Graph page is selected.

5.12.2 Select Demo Mode

1. Open the Tool Page to select and load any tool.
(Note its current Connection setting)



2. Choose [Connection] and then [Set].

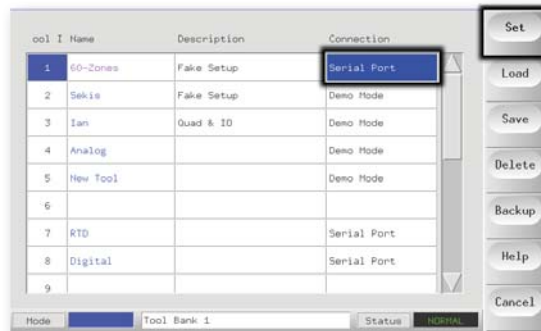

3. In the Select-Connection option box, choose [Demo Mode].

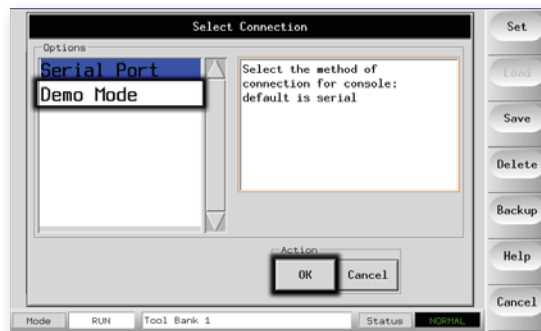

Training and Demonstration Mode - cont.

4. Accept the warning that this option will disable the Console.

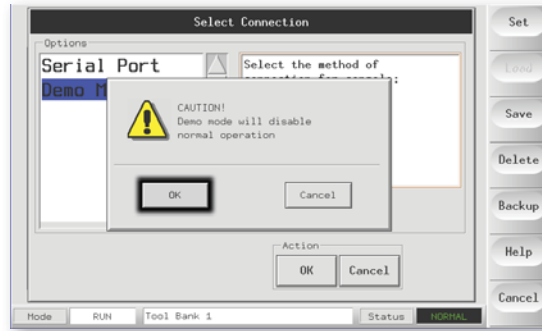

5.12.3 De-select Demo Mode

Taking the console out of Demo mode is a simple reverse of the Selection routine.

1. Select the current tool.
Choose [Connection], and [Set].

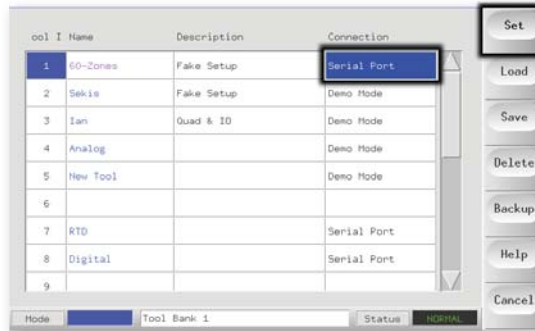

2. Select the original setting that was noted at Step 2 while selecting Demo Mode above.

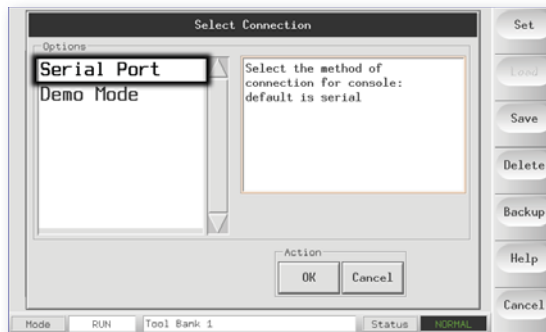

5.13 Use the Tool Store Page

The initial window shows the twenty tool slots alongside which the [PgUp] and [PgDn] buttons scrolls to five more tool pages giving a total capacity of 100 different tool settings.

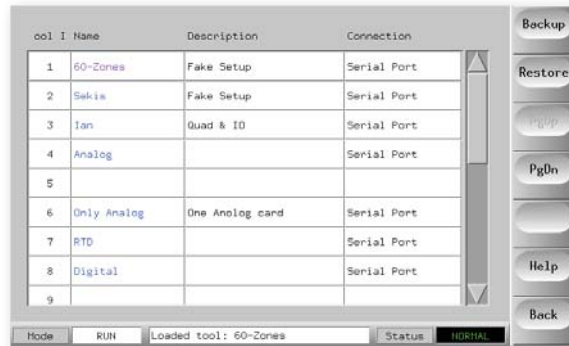

The main window has four columns containing the following information:

Tool - the allocated tool number.

Name - a user configurable text field for tool name.

The color of the name is a key that shows the state of tool:

- **black** - a tool store that has been named, but holds no settings.
- **blue** - a tool that has been saved and named, but is not in current use.
- **purple** - the tool that is currently in use and that has no changes to any settings.
- **red** - the tool that is in current use but which has been changed from its stored settings.

Description - a user-configurable text field that may be used to hold an expanded description of the tool.

Connection - this normally defaults to Local Serial which indicates that the tool settings are stored locally within the console memory. However, if the console is networked, and thus connected to two or more controller cabinets, this may show the name of one or more remote HRC-NET cards. The Connection column also provides a demo facility as described earlier on page 5-17.

5.14 Create a New Tool

If you need to have different tools to use for different applications then you will need to create a new tool to hold alternative settings.

1. Choose a blank tool slot and then choose **[Save]**.



2. Use the keyboard and name the new tool.



3. Open the SetUp Page.

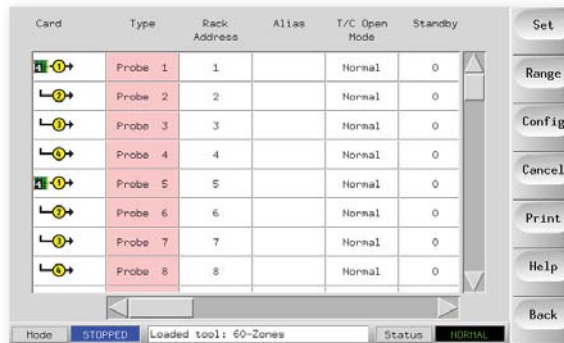

Create a New Tool - cont.

4. Select any zones that you need to change in the new tool and choose **[Set]**.

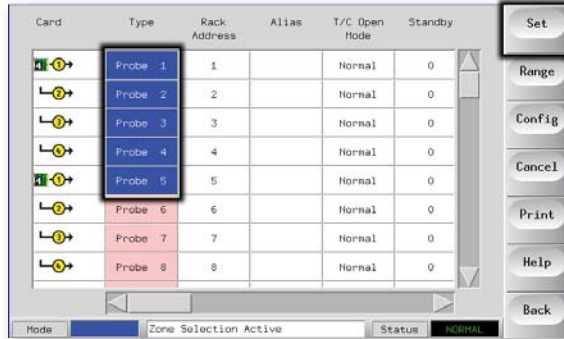

5. Use the Keyboard to input new values.



6. Finish the changes required for the new tool; then return to the Tool Page and choose **[Save]**.

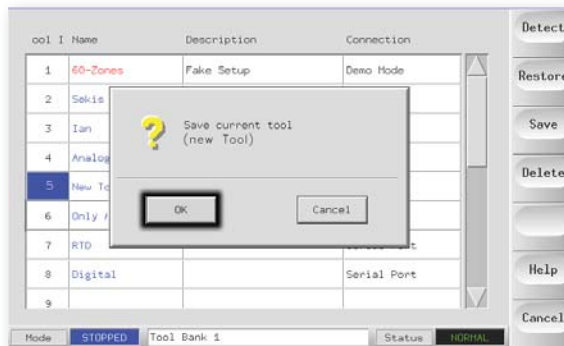

5.15 Rename an Existing Tool

1. Choose the relevant tool tab.

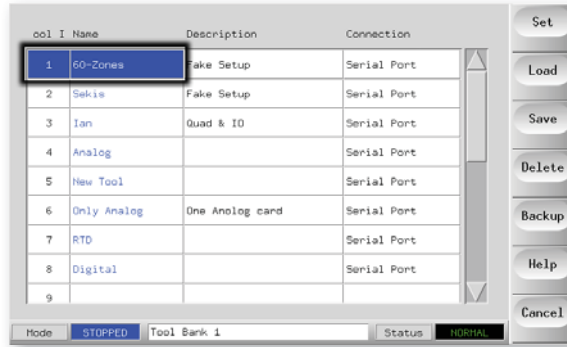

2. Choose the [Set] button.



3. Edit the name.



4. Choose [Enter].



5.16 Load Tool Settings (Locally)

Note that the operating mode for the controller cabinet remains unchanged by loading another tool. So, if your controller is in Run mode and another tool setting with different temperatures is selected, and loaded, then the tool will immediately change to run at the new incoming temperature settings.

1. Choose the desired tool.

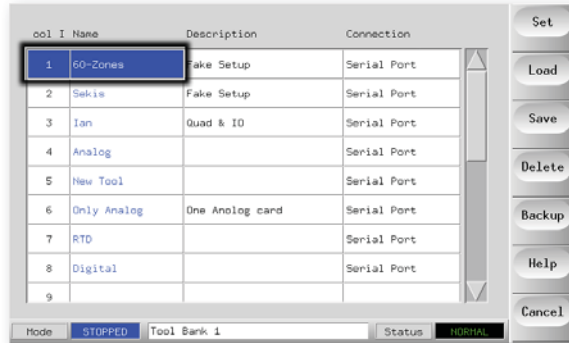

2. Choose [Load].
(If the [Load] button is greyed out then swapping Tools on-the-fly has been Disabled - See "Allow ToolLoad" page 3-22).



3. Choose [OK] (or [Cancel] to exit).

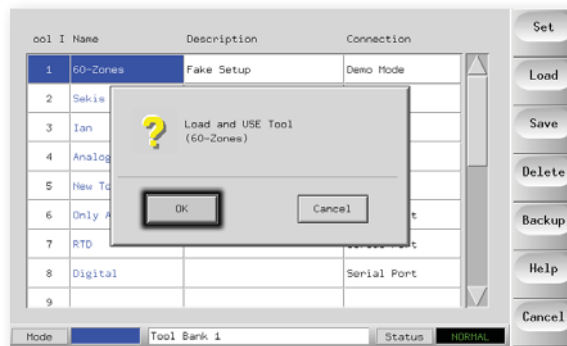

5.17 Save Tool Settings (Remotely)

If you change tool settings and want to save them, then you have two choices.

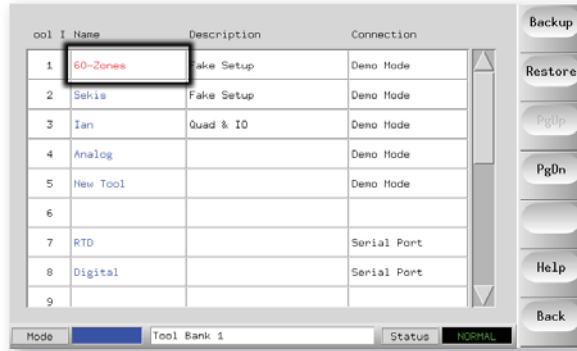

5.17.1 Over-Write the Last Settings with New Saved Settings

If you know that the new settings are satisfactory, then you can save them back into the same tool store.

1. Select the tool.

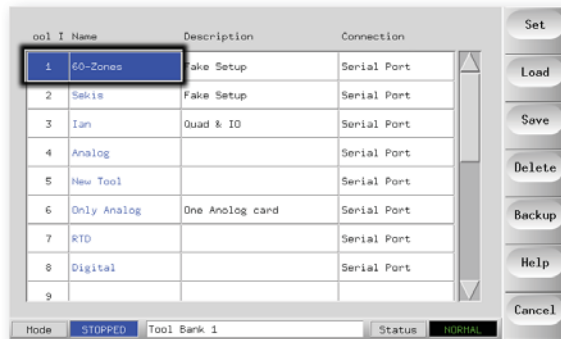

2. Choose [Save].



3. Choose [OK]

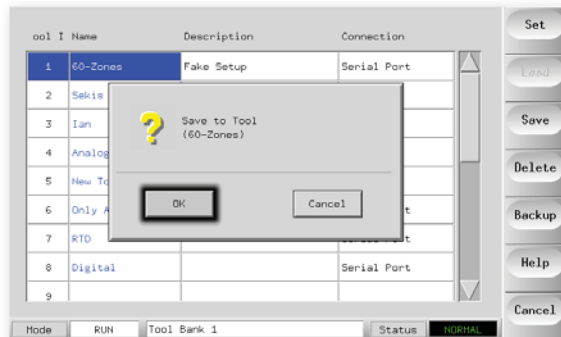

Save Tool Settings - cont.

5.17.2 Saving New Settings, Without Losing Existing Ones

If you have changed some tool settings and want to keep them but at the same time you wish to retain the old unmodified settings then you must create and save into a new store as follows:

1. Select a spare blank tool tab.

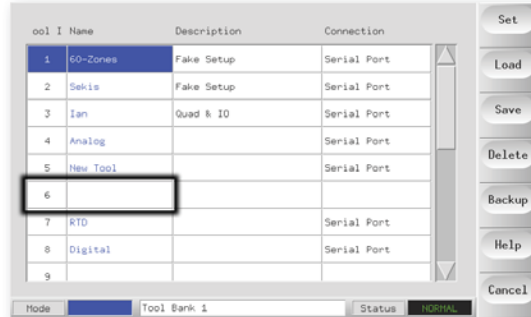

2. Choose [Save].

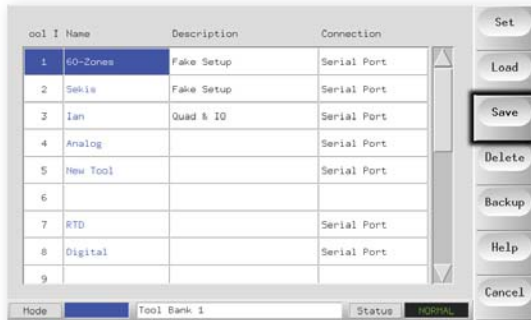

3. Choose [OK].

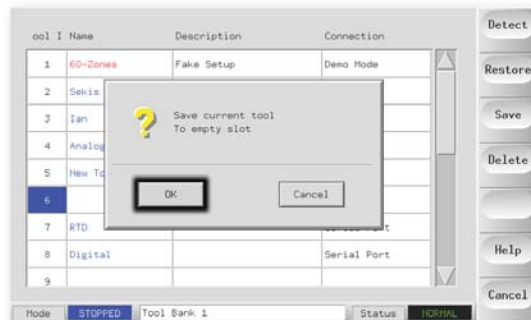

4. Enter a new tool name and choose [Enter].





5.18 Delete a Tool

Once you have deleted a tool there is no way to recover its previous settings. Take care that you are deleting the correct tool.

1. Select the unwanted tool.

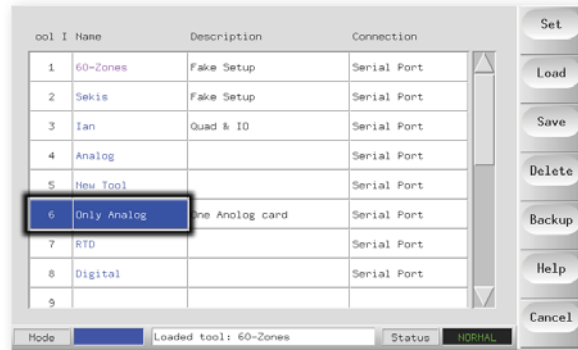

2. Choose [Delete].



3. Choose [OK].

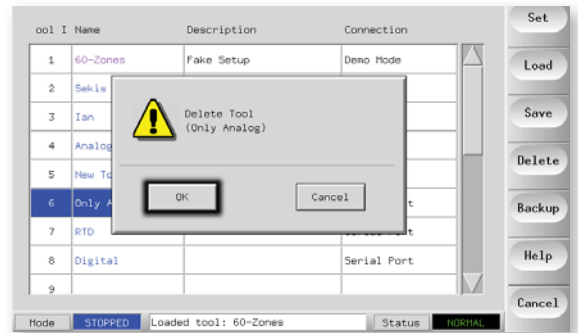

4. On return to tool page check to see unwanted tool is removed.



5.19 Back-up Tool Settings

Backing up tools is a means of saving tool settings to an external media which may be kept in a safe place for secure recovery or transferred to another controller for use elsewhere.

5.19.1 To Save (Backup) All the Tools

1. Open the ToolStore page.



2. Insert storage media then wait about 10 seconds until the USB Memory is ready to use.



3. Choose [Backup].

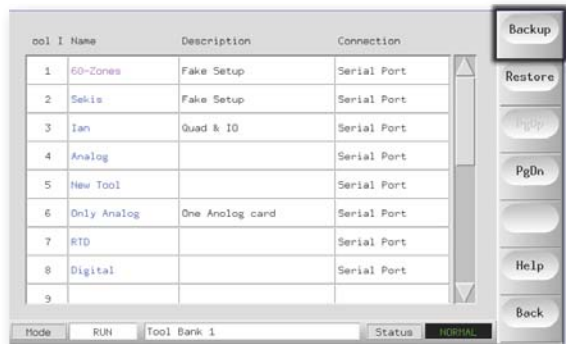

4. Wait about 10 seconds then remove storage media.



Back-up Tool Settings - cont.

5.19.2 To Save (Backup) one selected Tool Setting

1. Insert storage media then wait about 10 seconds until the USB Memory is ready to use.



2. Select the tool to Backup.

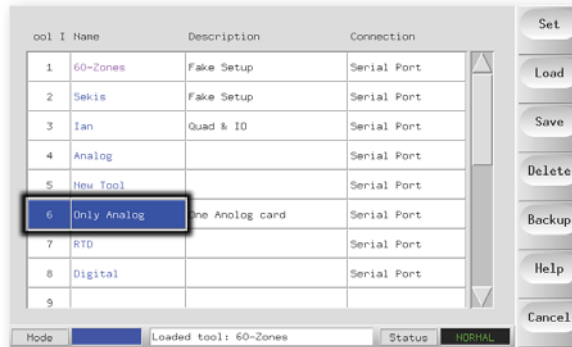

3. Choose [Backup].

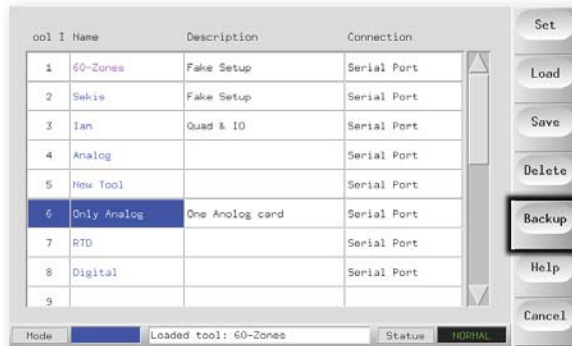

4. Wait about 10 seconds then remove the storage media.

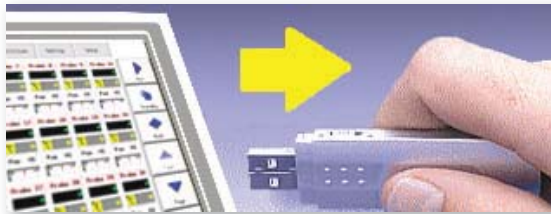

5.20 Restore Tool Settings

If there is any information stored in a selected tool bank or slot then this process over-writes new information into that position.

There is an option within this sequence to restore either all of the stored tools or just one selected tool.

5.20.1 To Restore All the Tools

1. Open the ToolStore page.



2. Insert the storage media with the data, then wait about 10 seconds until the USB Memory is ready to use.



3. Choose [Restore],

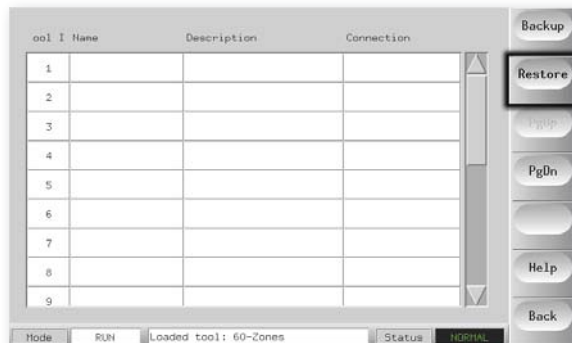

4. Wait about 10 seconds then remove the storage media.



Restore Tool Settings - cont.

5.20.2 To Restore a Single Tool

1. Insert the storage media then wait about 10 seconds until the USB Memory is ready to use.



2. Select the tool tab.

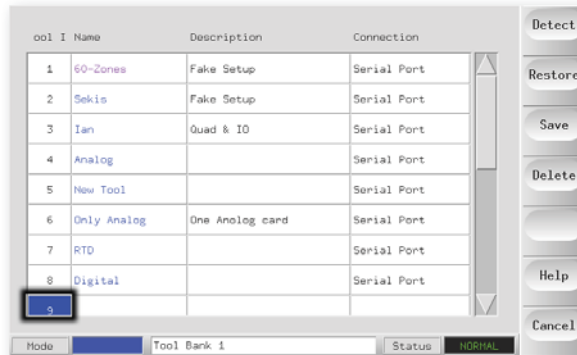

3. Choose [Restore].



4. Wait about 10 seconds then remove the media.



5.21 QCIO - 4-channel Input/Output Card

This is a digital Input/Output card that offers up to four separate inputs and outputs to facilitate remote interaction with the controller.

SetUp is available on the Utilities page where you can pick [**QuadIO**] to see the input and output selection.

5.21.1 Inputs

Each Input circuit requires an incoming pair that is volt-free and normally open. The incoming pair must go to short circuit (or close) to trigger the required command.

Optional inputs that may be selected are as follows:

Option	Description
Inactive	This input will not be used and remains inactive.
Run	Puts the Controller into RUN mode.
Startup	Puts the Controller into STARTUP mode.
Boost	Puts the Controller into BOOST mode.
Standby	Puts the Controller into STANDBY mode.
Shutdown	Puts the Controller into SHUTDOWN mode.
Stop	Puts the Controller into STOP mode.
Machine OK	When closed it allows console to go to Run or Startup Mode: If opened the console is put into "Stop" mode with resultant Mold Protect.
Passkey	Responds to an external Card-Key reader which is used to simulate User-level authentication. A Passkey input then allows any operation which would normally require a low-level (User) password

5.21.2 Outputs

Each Output group is a single-pole changeover relay element that is rated at 240 volts, 1Amp maximum. It comprises a common or moving contact (MC) that is connected to a normally-closed (NC) contact when de-energized. When the controller activates Output 1 or 2 the normally closed (NC) and moving contact (MC) go to open circuit while the normally open (NO) and moving contact (MC) go to short circuit.

Optional outputs that may be selected are as follows:

Option	Description
Inactive	This output will not be used and remains inactive
Inj Disable	Output is seen if the system is idle. Output is cleared once the system has started up and gone into "Run" mode. Output is given if system has an "out-of-limits" alarm. (no other alarm e.g. Fuse or T/C causes Output to be given).
Inj Disable Ext	This output mimics "Injection Disable" in order to provide two identical outputs.
Controller Alarm	Output is given if ANY alarm is generated. This mimics the secondary output alarm (beacon).
Hot Runner	Hot Runner. Output is given if any probe(nozzle) or manifold deviates from its set point enough to generate a second stage Alarm.
Temp Dist	An output is given if any Fatal Error occurs (e.g. Fuse or T/C etc).
Cavity Alarm	An output is given if any Cavity Zone (usually an RTD sensor) deviates from its Set temperature enough to generate a second stage Alarm.
Water Flow	An output is given if any Flow Sensor gives a flow reading that deviates from its nominal setpoint enough to generate a second stage Alarm.
Pressure Alarm	An output is given if any Pressure Sensor gives a pressure reading that deviates from its setpoint enough to generate a second stage Alarm.
Stopped	An output is given if the controller is automatically put into Stop mode by any detected alarm condition. (It is not activated if the controller is manually put to Stop mode by the user).
Boost	An output is given if the controller is put (locally or remotely) into Boost Mode.
Warn	A new proposed output which will be given if any zone deviates from its setpoint enough to generate a first stage Warning.

5.21.3 Default Input/Output Selection and Connector Pin Table

The standard interface is a Harting STA 20-pin female connector within an H-A16 housing.

Even though input/outputs channels may be individually configured to assume different functions, the default options are as shown in the following table along with the connector-pin configurations

I/O Connections

Description	STA 20 pin no.	Circuit	Default Input Function	Default Output Function
Input 1	1	Input 1	Go to RUN Mode	
Input 1	2			
NO Contact 1	3	Output 1		Injection Disable
MC Contact 1	4			
NC Contact 1	5			
Input 2	6	Input 2	Go to STANDBY Mode	
Input 2	7			
NO Contact 2	8	Output 2		Temperature Disturbance
MC Contact 2	9			
NC Contact 2	10			
Input 3	11	Input 3	Go to STARTUP mode	
Input 3	12			
NO Contact 3	13	Output 3		Boost
MC Contact 3	14			
NC Contact 3	15			
Input 4	16	Input 4	Go to STOP Mode	
Input 4	17			
NO Contact 4	18	Output 4		Spare/ Inactive
MC Contact 4	19			
NC Contact 4	20			

Section 6 - Maintenance

Maintaining your controller is all about keeping it in order, checking records and settings and running self-diagnostic checks.

There are no user serviceable parts inside the Touch Screen controller and, in the unlikely event of equipment failure, you should return the unit for attention.

What is included in this section

Print Out Facility

Export Facility

Checking Touch Screen Alignment

Self Diagnostic Tests

System diagnosis results

Servicing and Repairing your controller

Upgrading

6.1 Print Out Facility

Most of the pages on your controller contain a Print button on the side screen and the printed output is as described below.

PAGE	PRINTOUT
Main	Prints out the Zone Name, Actual and Set Temperatures, and Power level for ALL zones regardless of how the main page display is currently set.
Tool	Select any tool and print out the tool details, the printout is similar to the SetUp page. You do not have to load the tool to print its details.
Diagnose	Prints out the results of a tool test.
Utils	Prints out all the current Utility settings for the tool that is currently loaded.
SetUp	Prints out the whole SetUp page with all the current settings for the current tool.
Graph	Prints out an image of the current graph trace whilst it is not in any Close-up View-mode.

6.2 Export Facility

You can extract the last 30 minutes of zone performance data as a zipped spreadsheet. This data is written in a CSV (comma separated value) form, and then compressed into a zip file before exporting.

1. Insert storage media then wait about 10 seconds until the USB Memory is ready to use.



2. Select Utilities page and choose **[Export]**.

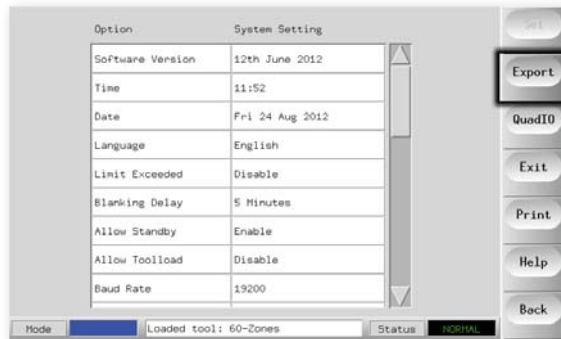

3. Choose the **[First Zone]** and pick the first zone from the List.

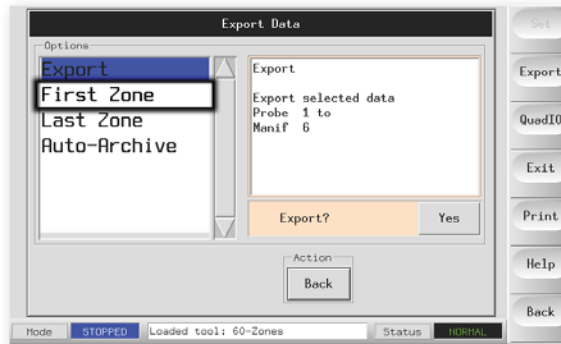

4. Repeat for the **[Last Zone]**.



Export Facility - cont

5. Choose [**Export**] and [**Yes**].

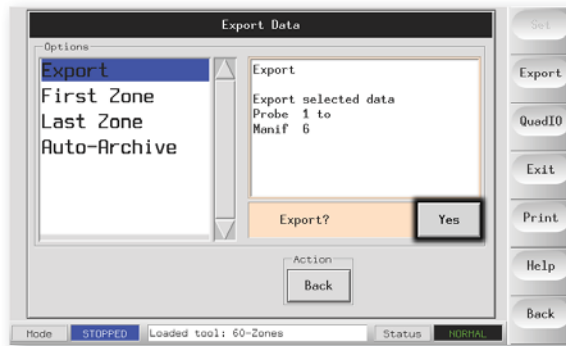

6. A further choice is to automatically archive performance data. If the [**Auto-Archive**] is switched to "On" and a USB flash memory left plugged into the console, then historic data is written to that USB device every 30 minutes.



7. When done remove the media and take it to a Personal Computer.

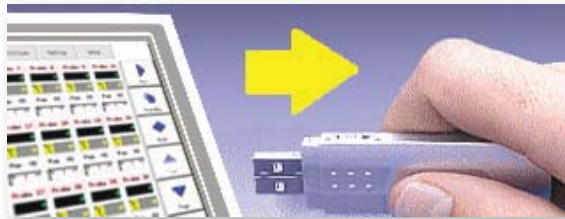

8. Import all the Data in to a spreadsheet.



6.3 Checking Touch Screen Alignment

If you find that there appears to be a misalignment between where you touch the screen and what part responds then there is a re-alignment facility that can be found on the Utilities page. This runs a brief target and choose the calibration routine which can realign touch to response.

The Calibration routine places a cross-hair target at five different positions on the screen. You should use a suitable stylus to make a small point contact area with the screen. Also, you should hold the stylus in position for a couple of seconds so that it can scan the screen several times and take a good average reading. Failure to do either may give rise to reading errors which does not lead to satisfactory calibration.

1. On the Utilities page choose **[Calibrate Touch]** and choose **[Set]**.



2. Choose **[Enable]** and choose **[OK]**.

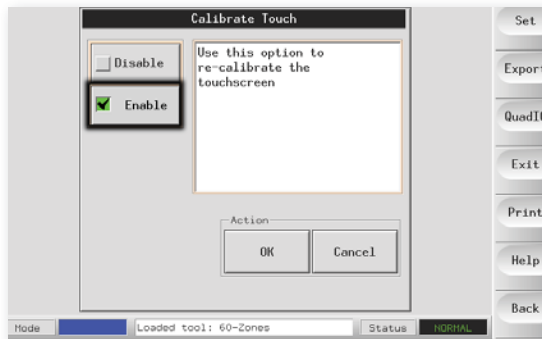

3. Touch the centre point of the cross hairs.
When you stop touching the screen, the cross hair target will move to another position.
Repeat until all five locations have been tested.

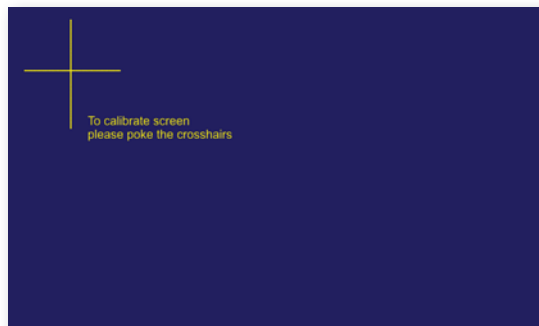

6.4 Self Diagnostic Tests

The Controller has a diagnostic testing tool, which has two main options within its test profile.

1. Power Test

Power Test is a facility that can only be used on Current Measuring cards. It performs a quick check to see that just the heater zones are functioning correctly and that the feedback from current sense coils are consistent with tools history file. It does not check for zone wiring errors or similar and it is designed as a maintenance aid only.

2. Full System Test

The Diagnostic test allows you to check that every zone is functioning correctly. It is the correct routine that you should use:

- as an acceptance check.
- to see that a new tool is wired up correctly.
- as a maintenance aid, to check that a working tool is functioning correctly.

The following describes the test sequence to show how it works.

1. It cools the whole tool	...during which time, all zones are checked to see that none experience a significant temperature rise.
2. It heats the first zone and checks to see that	a) the first zone rises sufficiently to qualify as a “Good Rise” – if not it increases the applied power and looks for the “Good Rise”. It continues to raise the power and look for a Good Rise until the configured “Heat Time” expires. If it does not see a good rise within that time then the zone has failed. b) the temperature of the zone under test does not reduce further – which would indicate a reversed thermocouple on that zone. c) no other zone rises enough to become a “Bad Rise” which would indicate excessive thermal conduction between adjacent zones. d) no other zone rises by as much as the “Good Rise” which would indicate cross-wiring between the zone under test and another thermocouple.
3. After completing the test on the first zone, the routine then moves on to subsequent zones until all have been tested.	

6.4.1 Why you may need to change your test parameters

Normally there is no reason to alter the test parameters in your self-diagnostic routine. Therefore, if you have any doubts or queries please contact your supplier for advice before you change any test parameters.

6.5 Running a Self Diagnosis Test

The diagnostic routine may be performed at any time that the controller is connected to the tool, provided that it is not in use for production.

The other panels on the page give feedback about how the test is progressing.

1. Open the Diagnose Page and choose [**Config**].

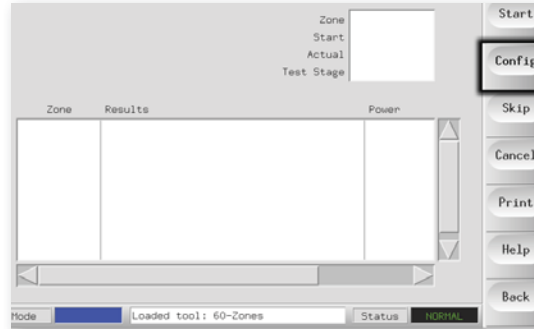

2. Choose [**First Zone**].

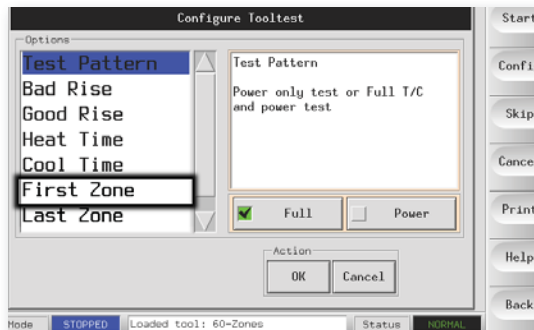

3. Choose the first zone in the test sequence.

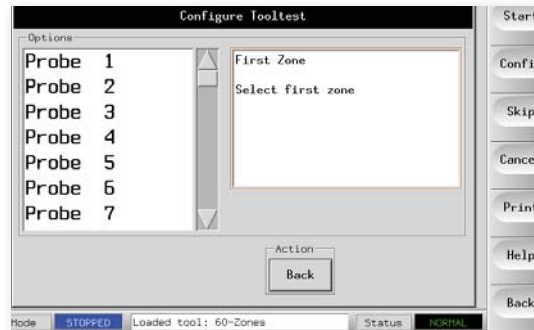

4. Choose [**Last Zone**] and select the last in the test sequence.

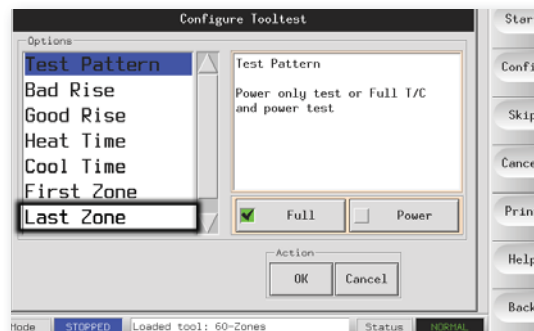

Running a Self Diagnosis test - cont.

- Choose either **[Full]** for a complete test or **[Power]** for a quicker power check only.
(This heats the zones to see current drawn but does not check zone interaction.)

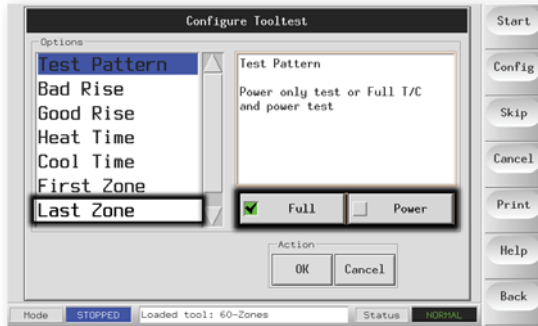

- Choose **[Start]** and observe that:
 - Test progress for each zone is shown in the upper right panel.
 - Test history for all zones is shown in the lower main panel.

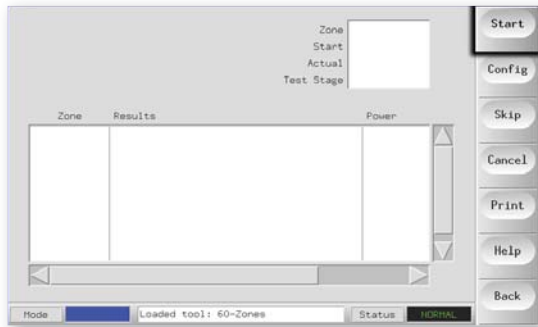

- To pass by or skip any zones choose **[Skip]**.

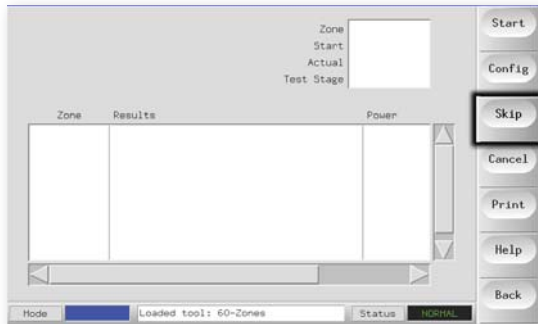

- To stop the test and omit remaining zones, choose **[Cancel]**.

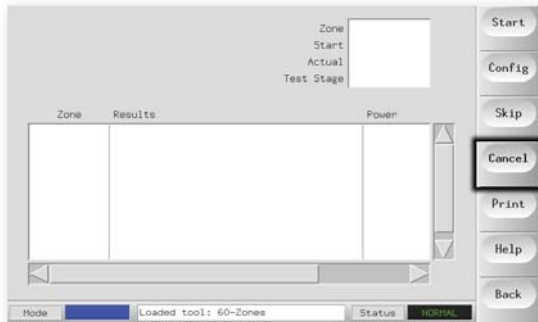

6.6 System diagnosis results

The Test page retains information about any test that is run. You can scroll the screen to view all the results or choose [**Print**] for a hard copy.

6.6.1 Interpreting the Test Results

Satisfactory Test

If the diagnostic test finds no fault with any zone then the message “Zone Test OK” is displayed.

Unsatisfactory Test

If the test detects any problems then it displays an error messages against the particular zone. Below is a complete list of the various messages along with further detail and possible causes.

User skipped Test - You skipped the test for this zone by pressing [**Skip**] while it was being tested.

User Aborted Test - You aborted out of the test by pressing [**Cancel**].

Open Circuit T/C - Thermocouple detected as being open circuit. Check thermocouple wiring for displayed zone.

Blown Fuse - Check card fuse. This message is also displayed if the zone was set to use an off board triac that was not installed. N.B. Off board triacs have their own fuse.

No Mains Sync. Pulse - This is probably due to an error in the supply wiring.

No Card Present - No card was detected in the rack at the slot identified with the displayed zone.

Cooling Test Failed - All zone temperatures had to be stable or falling before the heating test begins. If any zones continued to rise with power set to zero within the cooling period, this error is raised.

Heating Test Failed - Temperature did not rise by the set number of degrees within the heating period. This may be caused by an open circuit heater, a pinched, shorted or dislodged thermocouple, or the zone was set to on board triac when the cabinet was wired for off board triacs.

Check for Reversed T/C - Temperature appeared to be decreasing when power was applied.

Below 0 or Reversed T/C - May be caused by a reversed thermocouple. Also, in the unlikely event that the test was carried out at an ambient temperature below 0°C, the controller would not work with the resulting negative temperature readings.

Failed to React Correctly - Unexpected results. This message is followed by further error messages.

T/C Interaction with zone NN? - A different zone(s) to the one being tested had an unacceptable rise in temperature (greater than Bad Rise set in Test Values). Indicates faulty T/C positioning or close zone proximity.

Heater/TC Common with zone NN? - Cross-wiring fault between displayed zones. Could be either Heater or thermocouple wiring at fault.

Message Overflow - There is a limited amount of memory available to store test results. If this message is seen, too many errors have occurred to store them all.



6.7 Service and Repair Your Controller

Always isolate your controller at source before you open the unit to inspect it or replace fuses.

Only use Ceramic Body Fuses on Control Cards, never use glass bodied fuses.



6.7.1 Replacement Parts

We do not expect that you will need to repair any controller parts at board level other than fuses. In the unlikely event of any board failure then we provide an excellent repair and exchange facility for all our customers.

6.7.2 Cleaning and Inspection

Any excess dust that has entered into the cabinet may be removed with a light brush and vacuum cleaner.

Any internal cable forms, that flex to accommodate opening doors, should be checked to see that there is no fraying, or damage, to cable insulation.

If the equipment is subject to vibration then we recommend that you use an insulated screwdriver to check that no terminals have become loose.

External cable-looms should be checked to see that there has been no damage to the flexible conduit, plugs or sockets. If the flex has been squashed, if there is visible damage, or if there are any exposed conductors, then, for your own safety, it must be replaced.

6.8 Software Upgrade

In order to maintain our high quality, our development engineers are making continual improvements to our control system.

It may be possible to apply system upgrades to your own controller; however, this would depend on the type and age of your equipment. Please contact your supplier and provide the serial number for your model to find out if your particular console can be upgraded.

There is usually no need to return your control system to your supplier for any upgrades. They may be downloaded via the internet.

These following instructions will guide you through the upgrade procedure:

6.8.1 Preparation

1. Download the upgrade from the internet onto your PC.
2. Copy the upgrade program/data onto USB storage media.
3. Before you start any upgrade, shutdown your machine to leave your console free.

6.8.2 Procedure

1. Release the controller from any production working.
2. Plug the Flash Memory into the MTS USB socket then wait about 10 seconds until the USB Memory is ready to use.
3. Reboot the console (Choose **[Menu]**, **[Utilities]** and **[Exit]** then restart) and let the Upgrade self-install.
4. Remove the USB Flash Memory and reinstate the controller back to production running.

Section 7 - Troubleshooting

The control system has several features, which provide an early diagnosis of faults in the control system, the tool heaters and thermocouple sensors.

If the system detects any malfunctions, in one or more of the control zones, then it displays an error message on the main page in place of a temperature value.

If the system detects any abnormal condition it displays a warning message in the Main menu.

7.1 Fault and Warning Messages

Any of the following messages may be displayed on the Fault Indication line:

Error Message	Cause	Action
AMPS	The controller is unable to supply the current requested. (Note: This error message is most likely to be seen if the particular zone is set as a Spear type).	Isolate system supply, check loom and heater wiring continuity. Also, check the heater resistance against other known good zones to see that it is not noticeably higher than average.
ERR!	Little or no temperature rise has been detected in that zone. When the console starts to apply power it expects to see an equivalent heat rise at the thermocouple. If the Thermocouple has been trapped and pinched elsewhere in the tool or cable then it cannot see the full heat rise that occurs at the tip. If left uncorrected then there is a danger that the zone could overheat and damage the tip. Instead the circuit maintains the output at whatever level it reached when the monitor circuit detected the fault and the error message was displayed.	Check thermocouple wiring, it may be reversed. Heater wiring may be faulty or element may be open circuit.
FUSE	The fuse for that zone has failed. Please Note: A fuse can only fail due to a fault external to the controller. Identify and rectify the fault before replacing the fuse. Note: The fuse detection circuit requires a continuous low level current through a high impedance bleed resistor to maintain the alarm condition. As a result the load circuit is still connected to the mains voltage supply and it is not safe to attempt to repair or replace the fuse without first isolating the circuit. If the fuse in question is mounted on a control card then it is safe to unplug the board in order to isolate the circuit and replace the fuse on the card.	Replace the fuse with one of the same rating and type, i.e. High Rupture Current load fuse. The blown fuse is located either on the control card or on the off-board triac module (If fitted).
GND	The system has detected an earth fault.	Check your heater wiring for a low impedance path to earth.

Fault and Warning Messages - cont.

Error Message	Cause	Action
HELP	There is a system failure and the console does not know how to respond. (This alarm may occur if an older model console is connected to a later version cabinet. If the early version console does not recognise an alarm that has been generated by a later generation control card then it cannot display an appropriate alarm message. The console software has a routine to check incoming messages and it flags up a HELP message if such a condition arises.	Please make a note of the serial numbers for both the controller and console. Also note the console software date on the Utilities page. Contact your supplier with this information to hand.
LINE	No mains supply synchronisation pulses being received. The three-phase supply is used in a cross-over detection circuit to generate timing pulses for accurate phase control and firing the triac. If the phase detection fails on one or two phases then there is no pulse to use to measure phase angle and the LINE error message is generated. Meanwhile, all circuits on the healthy phases will continue to work normally.	There is a phase detection circuit on each card and a common phase detection circuit on all other controller types. Although a fault in such circuits may cause the LINE error message, such fault is very rarely seen. The most common error is either the absence of one phase or, if a plug has been re-wired incorrectly, a swapped phase and neutral. If a LINE error message occurs then switch off and isolate the controller then check supply wiring for presence of all three phases.
LINK	This will occur if the console is switched to a remote controller with a network link but it cannot establish any communication with the remote unit. The console can display the appropriate zones for the particular tool but it cannot relay any temperature information. It shows a LINK fatal error in place of the actual temperature.	Check that the network link is good and/or the remote controller is still switched on and available.
LOAD	No load on that zone. Only occurs when in manual closed loop mode where the current is pre-set. The current sensing circuit has not detected a current flow; therefore, the zone is flagged as not having a load.	Isolate the system supply and check the connections between the controller and the tool heaters. Also, check the heater for continuity

Fault and Warning Messages - cont.

Error Message	Cause	Action
N/Z	All the control cards are interrogated in sequence, on a working controller you can see the SCAN LEDs flashing in a sequence as each card is briefly checked for satisfactory communication. If any card fails to respond to the console then an N/Z error message is displayed for the offending zone.	If every zone shows N/Z and no cards show or flash their SCAN LEDs then check the communication lead between the console and the controller cabinet. If only one or two zones are displaying N/Z then check the card for faults. If you have recently changed any cards and put any older discrete-component cards into a new controller that has surface-mount cards then it is possible that the console's modern scan speed is too fast for the older control cards. In such a condition, check the console baud rate and try setting it to Low. If this cures the problem and you later replace the older card for a newer surface mount version then remember to reset the Baud rate back to high for optimum working.
NONE	The console has detected a control card that has no settings.	This Error message may be seen fleetingly during switch on, it should disappear after the initial card scan. If the message persists then you may need to re-apply the correct card settings on the SetUp page.
REV	The card has detected an abnormal input at the T/C termination that indicates a shorted or Reversed thermocouple.	If the REV alarm persists then you should switch off the controller and investigate the offending zone. Alternatively you could slave the offending zone to a good zone until you have time to clear the fault.
T/C	An open circuit thermocouple has been detected and no auto-response has been selected in the T/C Open Error column of the SetUp page.	For immediate recovery you can either slave that control zone to an adjacent zone or change to open loop control.
TRC	If a triac fails it goes short circuit and passes full load current. In such a condition you have lost control of the load and cannot switch it off from the console. The TRC alarm flags up the fault state which relies on operator intervention to manually shut the system down. Note: the triac monitor does not function in auto mode. If the triac were to fail while the zone is run in auto then the only indication will be an abnormally high zone temperature because the triac is passing high, uncontrolled current. The TRC alarm is only seen if a triac fails on a zone that is running in closed-loop manual condition.	If the triac has failed, return to your supplier for repair.

7.2 System Warning Messages

The following are a few other messages that may appear instead temperature or fatal alarms. These are messages that warn of any abnormal condition.

Warning Message	Abnormal Condition
MAN	The control zone is in manual mode.
S #	The zone is slaved to another control zone, where # represents the number of that zone, i.e. S 2 means the zone is slaved to Zone 2. The same power is being sent to both zones. In the Main page, the set point displayed on the selected zone is the same as that on the slave zone.
TEST	Displayed when the zone is in diagnostic test mode.
WARN	If during the test procedure a temperature interaction is found between zones, this message is displayed.
FAIL	The zone under test has failed.

7.3 Individual Controller Card Diagnostics

If a fault on a control card is suspected, check the LED card status lamps.

From top to bottom they are:

SCAN – this LED flashes briefly as the controller interrogates each card in sequence.

FAULT – Should normally be extinguished. It lights to show that one zone on the card has detected an error. The nature of that error is displayed in the particular zone on the console, all of which are listed in the list of Fault and Warning message table listed on page 7-1

To remove a card from its slot, pull the red handles forwards and gently pull the card out. There is no need to switch off the main supply.



NOTE: The shrouded terminals on the Euro back board are live, unless the power supply is switched to OFF.

7.4 Other Problems with the Tool

If you find that the Controller is not running correctly and cannot resolve the problem with either the manual or on-line help then it may help us if we can see exactly how your system is configured.

1. Insert Media then wait about 10 seconds until the USB Memory is ready to use.



2. Open the ToolStore page.



3. Select the tool.

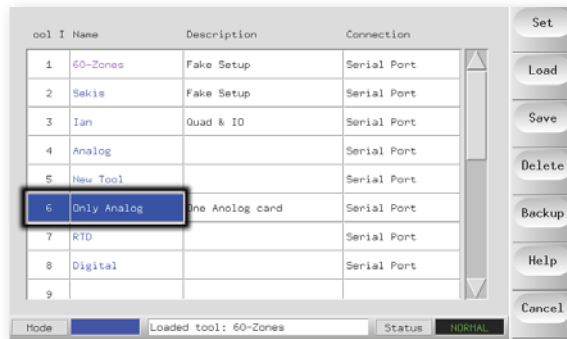

4. Choose [Backup].

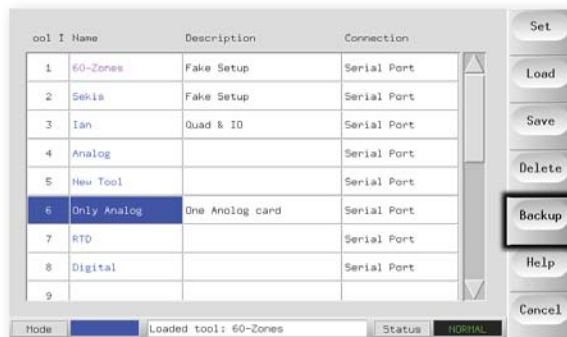

Other Problems with the Tool - cont.

5. Choose [**Export**] on the Utilities page.

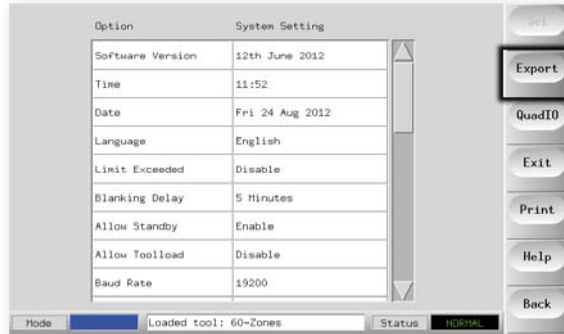

6. Select First and Last Zones to include All Zones.

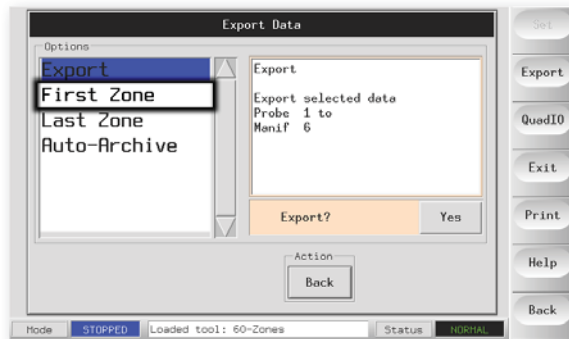

7. Choose [**Export**].

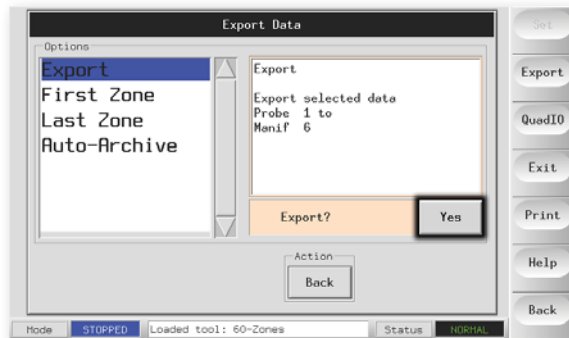

8. Wait about 10 seconds then Remove Media.



9. Copy the files to PC and Email them to "help@moldmasters.co.uk"



7.5 M1N Fuses and Overcurrent Protection

There is a Miniature Circuit Breaker that offers general over-current protection for the complete unit.

7.5.1 Replacement Fuses

If you find that any fuse has ruptured then please make sure that you replace the faulty fuse for a new one with identical characteristics. All the correct fuse types are listed in the following tables.

7.5.2 Supplementary Fuses

All the supplementary circuits (Console supply, Power Supply, fans) are protected a pair of fuses which are fed from the upper and lower supply busbars.

These are din-rail mounted and can be found inside the left side cover (viewed from the front) of an M1-48 and under the cover at the top on an M1-12.

Fuse	20mm Anti-surge
Rating	10 A

Controller Cards

The current controller card has protection fuses for both the T/C input and for the heating load output.



If the Fuse LED indicator shows that the output fuse has ruptured then the card may be easily removed and the fuse changed. Only use Ceramic Body Fuses on Control Cards, never use glass bodied fuses.

If the T/C LED indicator shows an open circuit T/C circuit then this may indicate that the input fuse has ruptured.

Output Fuse Type: 32mm Ceramic FF Ultra Fast

Fuse	1¼" (32mm) Ceramic FF Fast blow fuse
Rating	16A

Input Fuse Type: Surface-Mount

Fuse	Nano Ceramic Very Fast
Rating	62mA

Appendix A - HRC Wiring Details

SSTSP Plus Wiring Standards

The following standards only apply to controllers wired to standard orders. Other specifications may have been stated when the controller was ordered. Please refer to the supplied specification details.

Filter Option

In countries where noise across power lines is a concern, we recommend that you fit the model 63AYC10B in-line filter which is supplied by TC Connectivity.

Three Phase Designation -Star /Delta Option

Please take extreme care when connecting the controller to the three-phase supply.

The cabinet comes with a five-core mains 3-phase cable which may be used for either Star or Delta configuration. There are connectors within the case to change between Star and Delta supply.

Do not change the supply wiring until the controller has been disconnected from all electrical supplies.

If you change the configuration from Star to Delta, then the neutral wire must be made safe in order to protect from a live back feed.

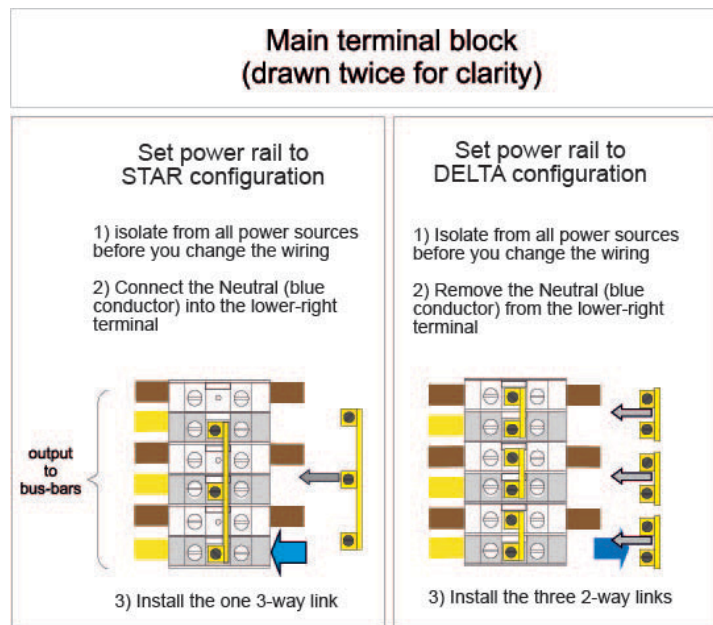

At the upper connection blocks, located behind the left hand panel, change the Star/Delta cross-links using a single 3-way link for Star supplies or three 2-way links for Delta supplies. The connector strip shows the appropriate cross-links to use and looks similar to this diagram.

Please take care with Star/Delta configuration since incorrect connection may appear to work but can result in damage to the controller.

Alarm Output / Auxiliary Input

An option cabinet connector provides an alarm output from an internal set of relay contacts. Using an external power source the cabinet can initiate a number of warning devices whenever any zone goes into an alarm state. This is commonly used for beacons, audible alarms or informing the molding machine. In order to capture fleeting alarm conditions, the relay is held on for about 15 seconds after the alarm condition is cleared. The contacts are rated for 5A at 240V.

Pin	Connection	Input / output
1	Auxiliary Input signal	Standby
2	Auxiliary Input Ground	
3	Alarm 240v contact 1	Normally Open Contacts
4	Alarm 240v contact 2	

An optional input can be accepted through the same connector. It may be used for Cycle Synchronizer tips, Inhibit Mode, remote Boost or Standby or any other user-definable function. For exact details, consult the specification for the particular model.

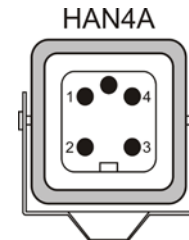

USB Port

A USB socket is provided which enable certain functions such as

- backup and restore tool settings
- save tool-test results
- printer output

Pin	Connection
1	VCC
2	D-
3	D+
4	GND



Standard Tool Connections

The diagrams below show the preferred standard for power and thermocouple connection cables. Custom Controllers may differ, in which case a unique wiring data sheet supplements the manual and these two pages may be ignored.

6-zone only – single HAN24E

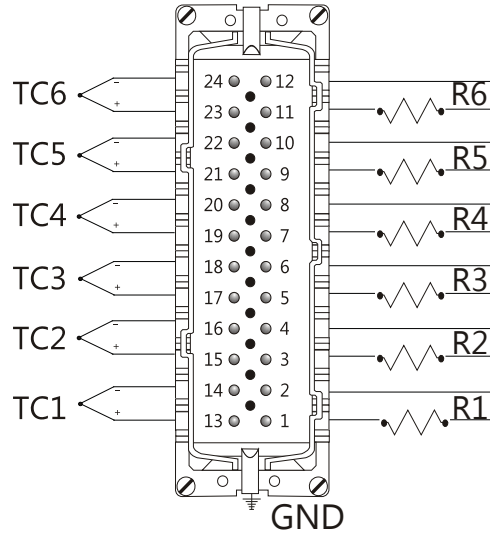

Zone	Pin
R1	1(L), 2(N)
R2	3(L), 4(N)
R3	5(L), 6(N)
R4	7(L), 8(N)
R5	9(L), 10(N)
R6	11(L), 12(N)
T/C 1	13(+), 14(-)
T/C 2	15(+), 16(-)
T/C 3	17(+), 18(-)
T/C 4	19(+), 20(-)
T/C 5	21(+), 22(-)
T/C 6	23(+), 23(-)
Maximum: 230Vac - 16A	

Harting 24B Housing with Double Lever

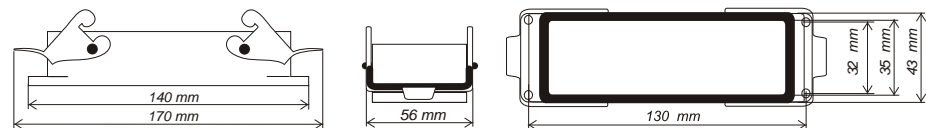

12-48 zones – pairs of HAN24E

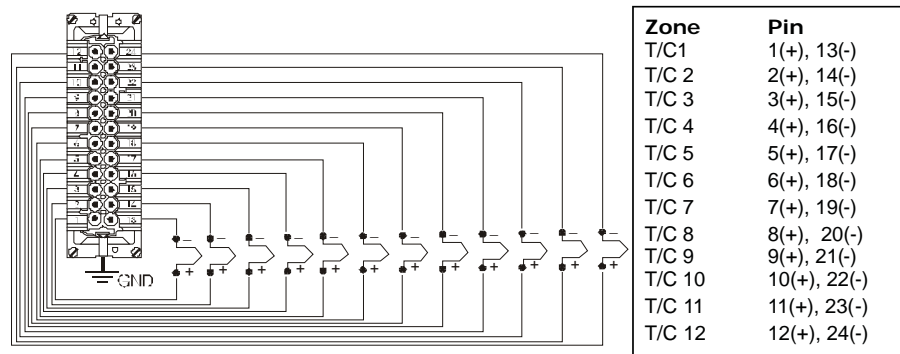
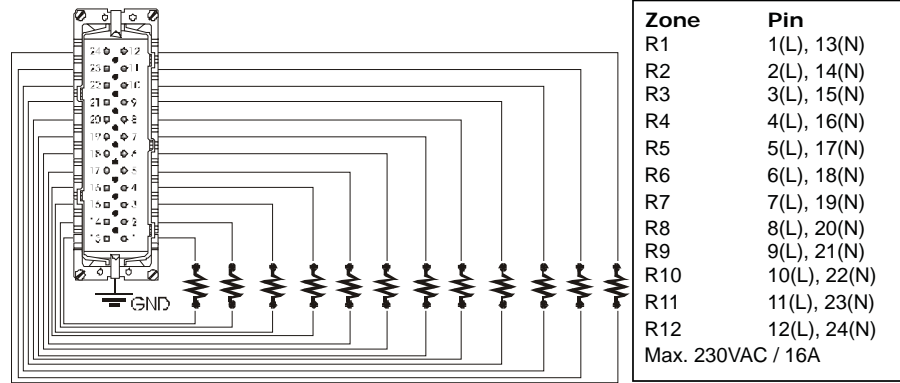

Harting 24B Housing with Double Lever

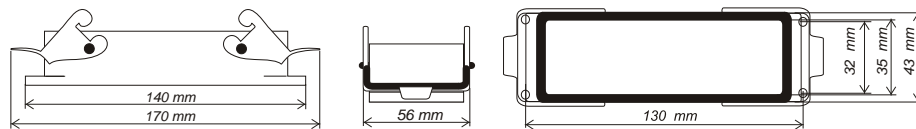

Touch Screen Schematic

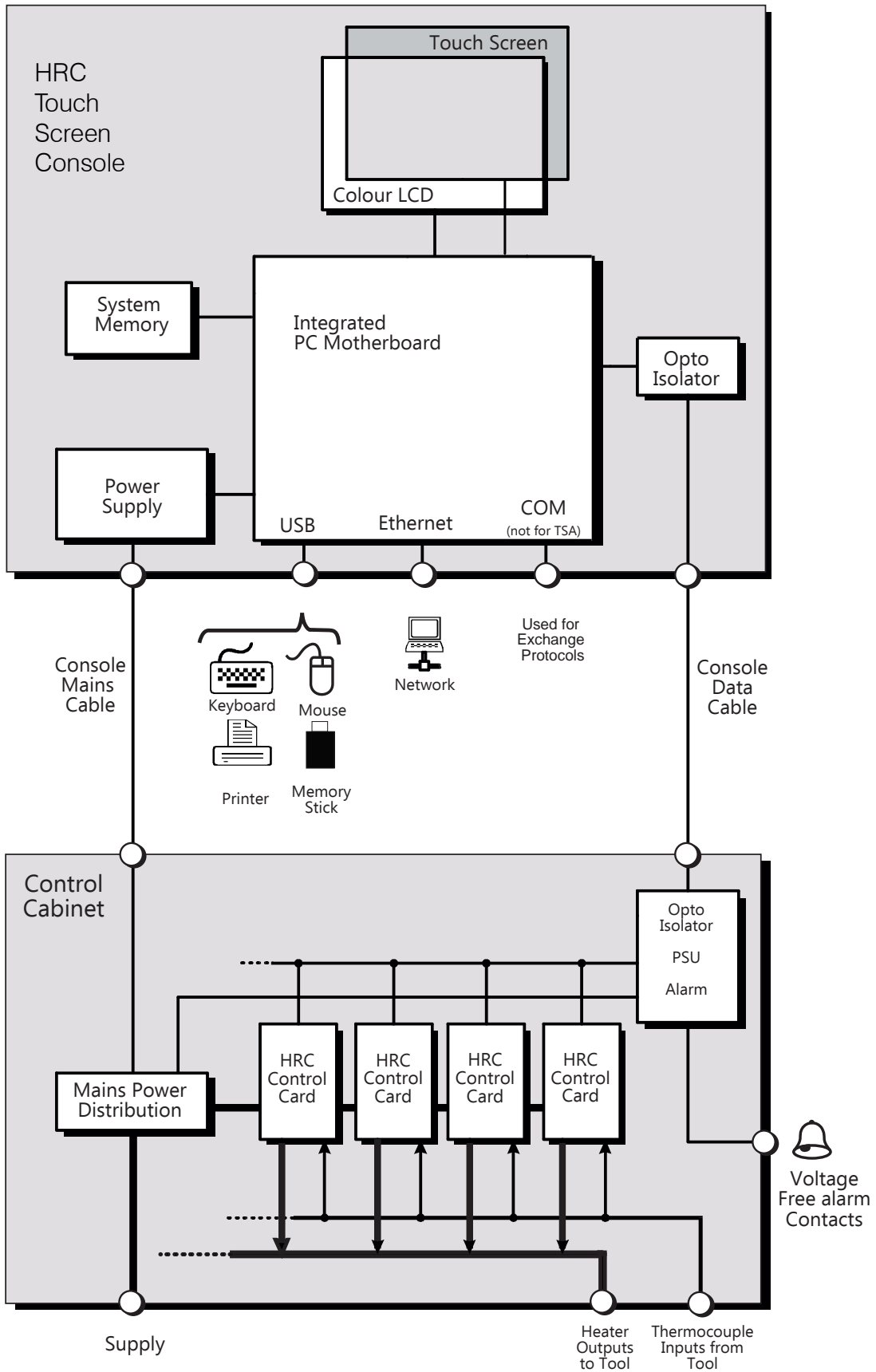

Index

Symbols

4-channel I/O Card 4-31

A

Alarm Power 3-9

Alarms 4-14

Alarms Active 3-10

Alarm Time 3-13

Alias 3-9

Allow Standby 3-24

Allow ToolLoad 3-24

Analogue Sensor Type 3-11

B

Back-up Tool Settings 4-27

Baud Rate 3-24

Beacon and Sounder 4-16

Blanking Delay 3-23

BOOST 4-3

Boost (temperature) 3-9

Boost Time 3-13

Button One Mode 3-13

C

Calibrate Touch 3-25

Card Indicators 4-16

Change Modes 4-6

Change Temperatures 4-5

Checking Past Performance 4-12

Check Zone Settings 4-11

Configure the Control Cards 3-5, 3-6

Configuring a Printer 3-29

Console Startup 3-24

Create a First Tool 3-3

D

Delay 3-11

Delete a Tool 4-26

Display Group 3-11

Display Mode 3-13

E

Edit Passwords 3-27

Export Facility 5-3

F

Fault and Warning Messages 8-1

Fuses 6-9

I

Input Signal 3-13

Input Timer 3-13

L

Language 3-23

Limit Exceeded 3-23

Load Tool Settings 4-23

M

Maintenance 5-1

Master Zone 3-9

Maximum Power Setting 3-10

Maximum Setpoint Setting 3-10

Minimum Setpoint Setting 3-10

Mode Window 4-14

More about Boost 4-4

More about Slaving Zones 4-7

N

N/Z Alarm 3-24

P

Password Active Times 3-26

Password Options 3-26

Password Override 4-28
Password Timer 4-25
Power Alarm Delay 4-14
Power Mode 4-14
Pre-Heat 4-11
Print Out Facility 6-2
Protocol Installed 4-25
Purge Sequence 5-8

R

Rack Position 4-9
Rename a Tool 5-22
Restore Tool Settings 5-29
RUN 5-2

S

Screen Layout & Navigation 3-5
Second Startup 4-14
Self Diagnostic Tests 6-6
Sensor 4-10
Service and Repair 6-10
Setting Temperature 3-9
Setting the Tool Parameters 4-8
SHUTDOWN 5-3
Shutdown Stage 4-11
Shutdown Temperature 4-15
Shutdown Timer 4-15
Software Upgrade 6-11
Speed 4-10
STANDBY 5-2
Standby (Temperature) 4-9
Standby Temperature 4-14
STARTUP 5-2
Startup Mode 4-14

Startup Stage 4-11
Status Window 5-15
STOP 5-2
Supply Voltage 4-25
Switching Off 3-4

T

T/C Offset Value 4-10
TC Open Mode 4-9
Temperature Precision 4-24
Temperature Scale 4-15
Three Phase Designation A-1
Time 4-11
Touch Screen Alignment 6-5
TouchScreen - Removal 7-5
Training and Demo Mode 5-17
Troubleshooting 7-1

U

User Password 4-25
Using the Tool Store 5-19

W

Warning and Alarm Levels 4-9

NOTES:

