

Series 965



1/16 DIN Microprocessor-Based Auto-tuning Control

Technical Manual

D-M-E Company

D-M-E Company, 29111 Stephenson Hwy., Madison Heights, MI 48071, Phone: 313/398-6000, Fax: 313/398-6174

CDME-MA10-9309
March, 1993

\$10.00
Made in the U.S.A.

| | | | |
|--------------|-----------------------|------------------|----------------------------------|
| Starting Out | • General Description | | |
| Install/Wire | • Panel Cutout | • Dimensions | • Power, Inputs, Outputs, Alarms |
| Front Panel | • Key Functions | • Displays | • LEDs |
| Setup | • Setup Menu | • Operation Menu | • Parameter Tables |
| Tuning | • Tuning | • Alarms | • Error Codes |
| Appendix | • Noise Guidelines | • Calibration | • Specifications • Model Number |

Notes

The user's manual contains informational notes to alert you to important details. When you see a note icon, look for an explanation in the margin.

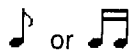
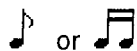

NOTE:
Details of a "Note" appear here, in the narrow box on the outside of each page.

Safety Information

This user's manual also has **boldface** safety information notes to protect both you and your equipment. Please be attentive to them. Here are explanations:



The Caution symbol (exclamation point) in the wide text column alerts you to a "**CAUTION**," a safety or functional hazard which could affect your equipment or its performance. A full explanation is in the narrow column on the outside of the page.



CAUTION:
Details of a "Caution" appear here, in the narrow box on the outside of each page.



The Warning symbol (lightning bolt) in the wide text column alerts you to a "**WARNING**," a safety hazard which could affect you and the equipment. A full explanation is in the narrow column on the outside of the page.



WARNING:
Details of a "Warning" appear here, in the narrow box on the outside of each page.

Technical Assistance

If you encounter a problem with your D-M-E Control, review all of your configuration information to verify that your selections are consistent with your application... Inputs, Outputs, Alarms, Limits, etc. If the problem persists after checking the above, you can get technical assistance by dialing: 1-313-544-5026

An Application Engineer will discuss your problem with you.

Please have the following information available when calling:

- Complete model number
- Bar Code Number
- All configuration information
- User's Manual

Your Feedback

Your comments or suggestions on this manual are welcome, please send them to: D-M-E Company, 29111 Stephenson Highway, Madison Heights, MI 48346

| Page | Item |
|-------------------|---|
| Chapter 1 | |
| 4 | Starting Out With The D-M-E Series 965 |
| 4 | General Description |
| Chapter 2 | |
| 5 | Install And Wire The Series 965 |
| 5 | Panel Cutout |
| 5 | Dimensions |
| 5 | Installation Procedure |
| 7 | Wiring the Series 965 |
| 8 | Sensor Installation Guidelines |
| 8 | Input Wiring |
| 10 | Output 1 Wiring |
| 11 | Alarm Wiring |
| 12 | System Wiring Example |
| Chapter 3 | |
| 13 | How To Use The Keys And Displays |
| 13 | Keys, Displays & LED's |
| Chapter 4 | |
| 14 | How To Setup The Series 965 |
| 14 | Setting the Input Type DIP Switch |
| 15 | Entering Setup Menu |
| 16 | Setup Parameters |
| 18 | Setup Menu Table |
| 19 | Operation Parameters |
| 20 | Operation Menu Table |
| Chapter 5 | |
| 21 | How To Tune And Operate |
| 21 | Auto-tuning |
| 22 | Manual Tuning |
| 23 | Manual and Automatic Operation |
| 24 | Using Alarms |
| 25 | Error Code Messages |
| Appendix 1 | |
| 27 | Noise Sources |
| 27 | Decreasing Noise Sensitivity |
| 28 | Eliminating Noise |
| Appendix 2 | |
| 29 | Entering the Calibration Menu |
| 30 | Restoring Factory Calibration |
| 30 | Calibration Menu |
| 31 | Calibration Procedures |

| | |
|----|--------------------------|
| 34 | Glossary |
| 36 | Index |
| 37 | Warranty |
| 37 | Returns |
| 37 | D-M-E Company |
| 38 | Specifications |
| 39 | Model Number Information |
| 41 | Quick Reference |

Figures & Tables

| Page | Item | Figure |
|------|--|--------|
| 4 | Series 965 Input & Output Overview | 1 |
| 5 | Multiple Panel Cutout Dimensions | 2 |
| 5 | Series 965 Dimensions | 3 |
| 6 | Mounting, Case Sideview & Collar | 4 |
| 6 | Case, Rear View & NEMA 4X Seal | 5 |
| 7 | High Voltage Power Wiring | 6 |
| 7 | Low Voltage Power Wiring | 7 |
| 8 | Thermocouple Wiring | 8 |
| 8 | 0 - 5VDC Process Input Wiring | 9 |
| 9 | RTD Wiring Diagram | 10 |
| 9 | 4 - 20mA Process Input Wiring | 11 |
| 10 | DC Output 1 (Open Collector) Wiring | 12 |
| 10 | Mechanical Relay, Output 1 Wiring | 13 |
| 10 | Process, 4-20mA Wiring | 14 |
| 10 | Solid State Relay w/o Suppression Wiring | 15 |
| 11 | DC Output 2, Open Collector Wiring | 16 |
| 11 | Mechanical Relay w/o Suppression, Output 2 17 | |
| 11 | Solid State Relay w/o Suppression, Output 2 18 | |
| 12 | System Wiring Example | 19 |
| 13 | Series 965 Keys and Displays | 20 |
| 14 | DIP Switch Location & Selection | 21 |
| 15 | Entering the Setup Menu | 22 |
| 15 | The Setup Menu | 23 |
| 19 | The Operation Menu | 24 |
| 21 | Auto-tuning at a 200°F Set Point | 25 |
| 24 | Alarm Display Examples | 26 |
| 29 | Entering the Calibration Menu | 27 |
| 30 | Calibration Menu | 28 |

Tables

| | | |
|----|------------------------------------|---|
| 18 | Input Ranges | 1 |
| 18 | Setup Menu Prompts/Description | 2 |
| 20 | Operation Menu Prompts/Description | 3 |
| 41 | Quick Reference Sheet (Perforated) | |

Chapter 1

Starting Out With The D-M-E Series 965,
A Microprocessor-Based Control

Figure 1 -
Series 965 Input and
Output Overview

General Description

Welcome to the D-M-E Series 965, a 1/16 DIN microprocessor-based temperature control. The 965 has a single input which accepts type J, K, T, N or S thermocouple, RTD or process input.

With dual output, the primary can be heating or cooling while the secondary can be a control output opposite the primary output (heat or cool), alarm or none. Both outputs can be selected as either PID or ON/OFF. PID settings include proportional band, reset/integral, and rate/derivative. Setting the proportional band to zero makes the Series 965 a simple ON/OFF control with switching differential selectable under the HSC parameter.

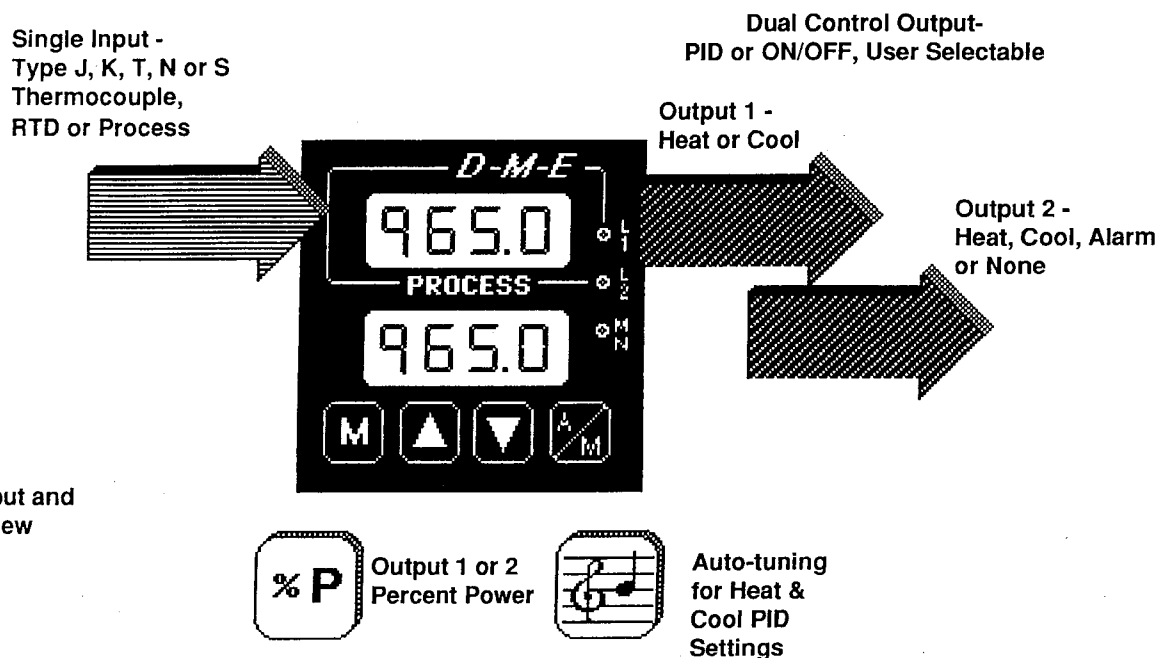
Special 965 features include the NEMA 4X rating, dual four digit displays, optional low volt power supply, auto-tuning for both heat and cool outputs, ramp to set point for gradual warm-up of your thermal system, and automatic/manual capability with bumpless transfer.

Operator-friendly features include automatic LED indicators to aid in monitoring and setup, as well as a calibration offset at the front panel. The D-M-E Series 965 automatically stores all information in a non-volatile memory.

Install and Wire the Series 965

NOTE:

Measurements between panel cutouts are the minimum recommended.

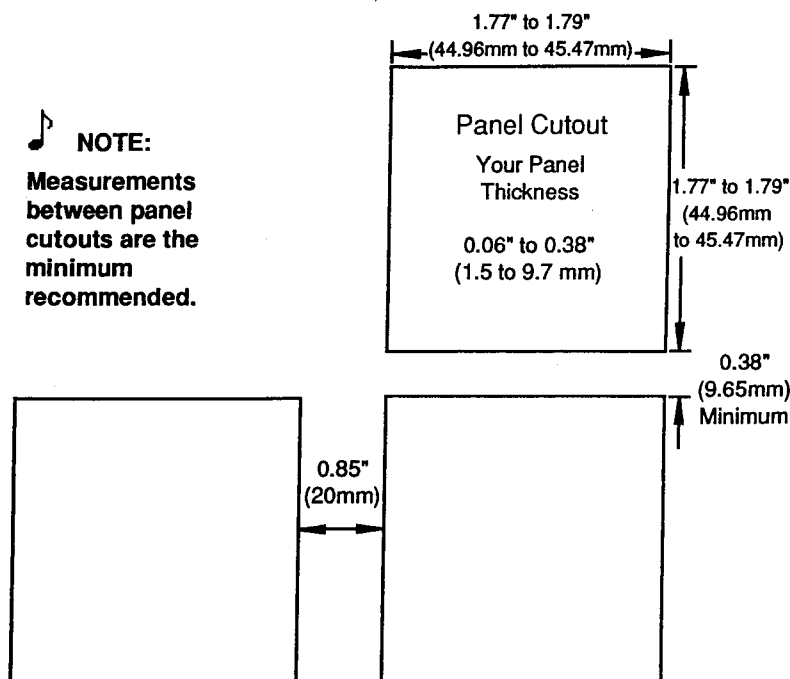

Figure 2 - Series 965 Multiple Panel Cutout Dimensions

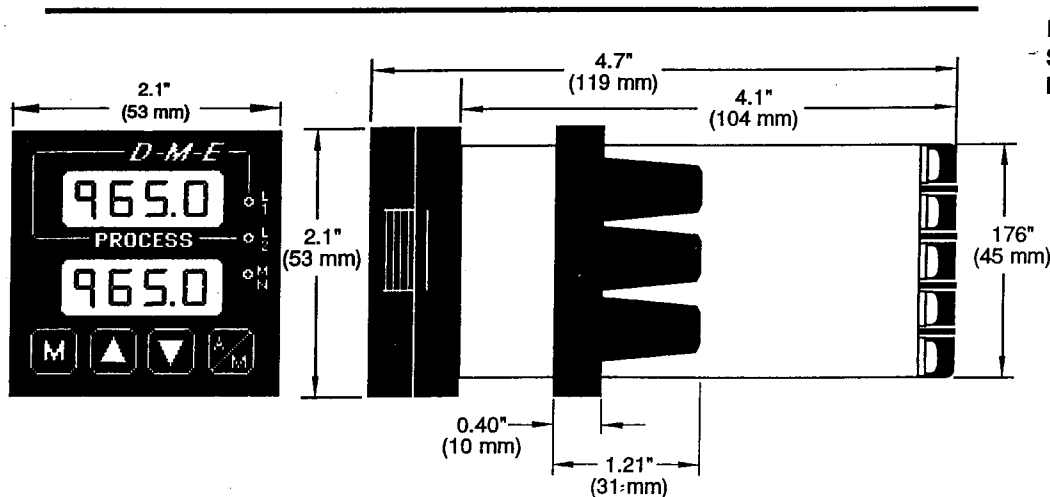

Figure 3 - Series 965 Dimensions

Installation Procedure

Follow this procedure to mount the D-M-E Series 965 temperature control:

1. Make a panel cutout per the dimensions in Figure 2.
2. Remove the 965 chassis from its case. Holding each side of the bezel, press in firmly on the side grips until the tabs release. Pull the chassis out of the case and set aside for later installation.
3. Make sure the rounded side of the external case gasket is **facing** the panel surface. Check to see that the gasket is not twisted, and is seated within the case bezel flush with the panel. Place the case in the cutout you just made. Make sure the gasket is between the panel cutout and the case bezel. See Figure 4A.

NOTE:

Removing the Series 965 chassis from its case will make mounting easier.

Figure 4 -
Mounting, Case Side
View & Collar Cross
Section

4A

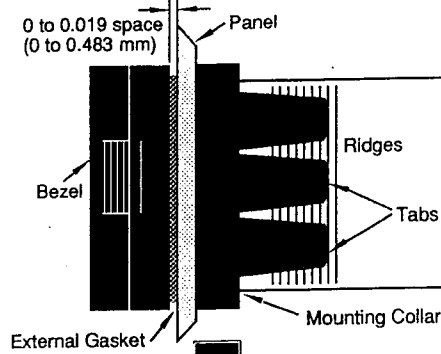

4B

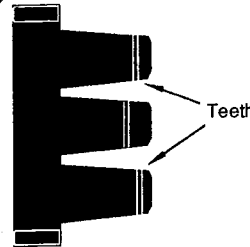

**Mounting Collar
Cross Section
(notice the offset teeth
on each tab)**

- While pressing the front of the case firmly against the panel, slide the mounting collar over the back of the control. The tabs on the collar must line up with the mounting ridges on the case for secure installation. See Figure 4A again. Slide the collar firmly against the back of the panel getting it as tight as possible. Make sure you cannot move the case within the cutout, if you can you do not have a NEMA 4X seal.

NOTE:

To guarantee a proper NEMA 4X seal, make sure the gasket between the panel and the rim of the case is not twisted and is seated properly.
PRESS FIRMLY.

Now let's make sure we have a tight seal. Use your thumb to lock the tabs into place while pressing the case from side to side. Don't be afraid to apply enough pressure to install the control. The tabs on each side of the collar have teeth which latch into the ridges. See Figure 4B. Each tooth is staggered at a different height, so only one of the tabs on each side are ever locked into the ridges at any time.

Looking at Figure 5, you see that the tabs on one side of the collar correspond with those on the opposite side. Make sure that the two corresponding tabs are the only ones locked in the ridges at the same time. If the matching tabs are not holding the case at the same time you **will not** have a NEMA 4X seal. You can make a visual check, or use your finger nail to pull out on each tab. **Only one on each side is engaged, and they must be corresponding as in Figure 5.** The space between the bezel and panel must be between 0 and 0.019" (0.48 mm).

Make sure that the two corresponding tabs below are locked in the ridges at the same time.

Figure 5 -
Case Rear View and
NEMA 4X Seal
Example

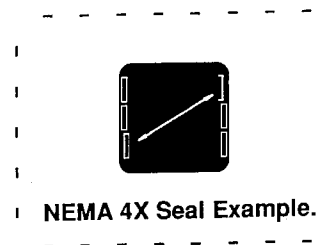
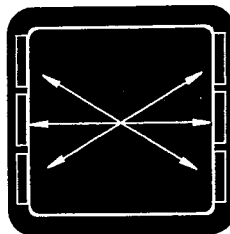

When removing the mounting collar, we suggest sliding a thin tool such as a putty knife or screwdriver under all three tabs on each side at once and pulling it back off the case.

- Insert the control chassis into its case and press the bezel to seat it. Make sure the inside gasket is also seated properly and not twisted. The hardware installation is complete. Proceed to the wiring section from here.

The Series 965 wiring is illustrated by model number option. Check the unit sticker on the control and compare your model number to those shown here and also the model number breakdown in the Appendix of this manual.

All outputs are referenced to a de-energized state. The final wiring figure is a typical system example.

When you apply power without sensor inputs on the terminal strip, the Series 965 displays "- - -" in the upper display, and a "0" in the lower display, except for 0-5VDC or 4-20ma process input units. Press the A/M key twice, and ER 7 is displayed for one second. This error indicates an open sensor or A/D error. Remove power to the control and connect the sensor properly, see Page 8 & 9. All wiring and fusing must conform to the National Electric Code and to any locally applicable codes as well.

High Voltage

Model # DIN-965 _

100 to 240 VAC, nominal
(85 to 264 actual)

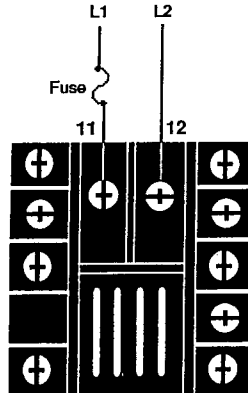

WARNING:

To avoid potential electric shock, use National Electric Code (NEC) safety practices when wiring and connecting this unit to a power source and to electrical sensors or peripheral devices.

Figure 6 - High Voltage Power Wiring

Low Voltage

Special order: Please contact D-M-E customer service



12-24VAC or VDC

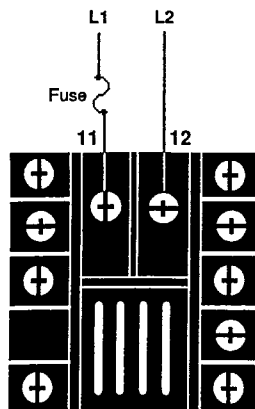

CAUTION:
If high voltage is applied to the low voltage unit, irreversible damage will occur.



WARNING:

If high voltage is applied to the low voltage unit, irreversible damage will occur.

Sensor Installation Guidelines

We suggest you mount the sensor at a location in your process or system where it reads an average temperature. Put the sensor as near as possible to the material or space you want to control. Air flow past this sensor should be moderate. The sensor should be thermally insulated from the sensor mounting.

See Chapter 4 for more information on DIP switch location and orientation.

Thermocouple Input

When an external device with a non-isolated circuit common is connected to the 4-20mA or DC (open collector) output, you must use an isolated or ungrounded thermocouple.

Extension wire for thermocouples must be of the same alloy as the thermocouple itself to limit errors.

Figure 8 - Thermocouple Sensor Input Wiring

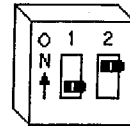
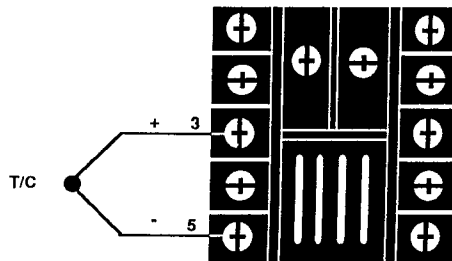

DIP Switch Orientation



CAUTION:
Process input does not have sensor break protection. Outputs can remain full ON.

0 - 5VDC Process Input

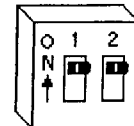

DIP Switch Orientation

Figure 9 - 0 - 5VDC Process Sensor Input Wiring

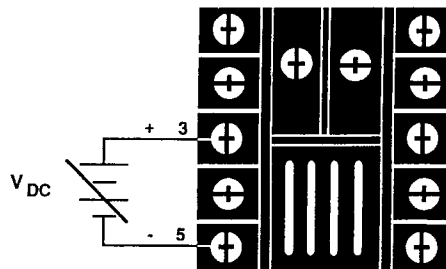

Input impedance: 10KΩ.

RTD, 2 or 3 Wire

There could be a + 2°F input error for every 1Ω of lead length resistance when using a 2 wire RTD. That resistance, when added to the RTD element resistance, will result in erroneous input to the instrument. To overcome this problem, use a three wire RTD sensor, which compensates for lead length resistance. When extension wire is used for a three wire RTD, all wires must have the same electrical resistance (i.e. same gauge, copper stranded, same length).

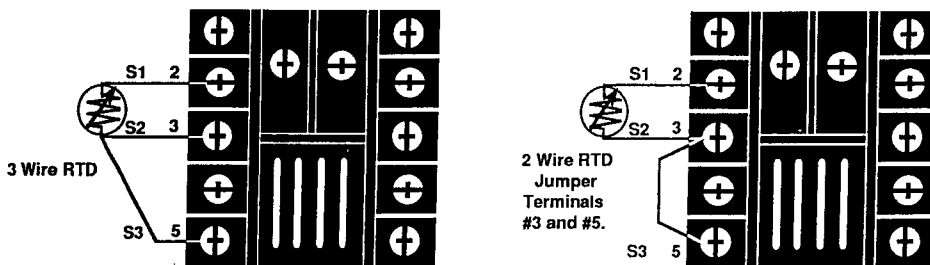
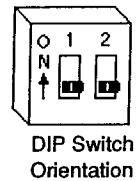
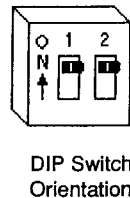
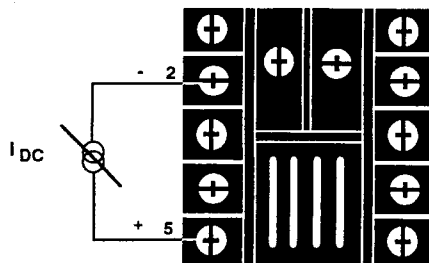

Figure 10 -
2 or 3 wire RTD
Sensor Input Wiring

4 - 20mA Process Input



CAUTION:
Process input does not have sensor break protection. Outputs can remain full ON.



Input impedance: 5Ω.

Figure 11 -
4 - 20mA Process
Sensor Input Wiring

Special order: Please contact D-M-E customer service

Figure 12 -
DC Output
(Open Collector)
Wiring

NOTE:

When an external device with a non-isolated circuit common is connected to the 4-20mA or DC (open collector) output, you must use an isolated or ungrounded thermocouple.

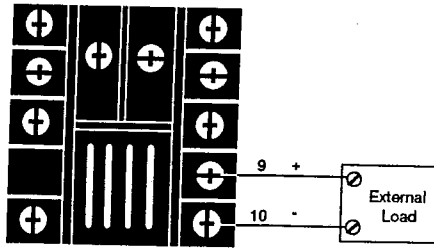

Figure 13 -
5 Amp Mechanical
Relay Wiring

NOTE:

A quencharc should be placed across all inductive loads (relay coils, solenoids, etc.)
D-M-E Part No.
DIN-0001

Mechanical Relay Without Contact Suppression, Form C, 5 Amp

Model # DIN-9651

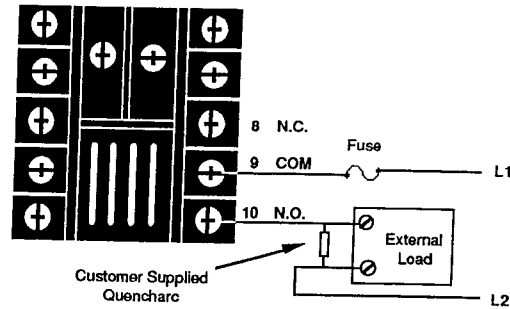

Figure 14 -
4-20mA Process
Wiring

Process, 4-20mA

Special order: Please contact D-M-E customer service

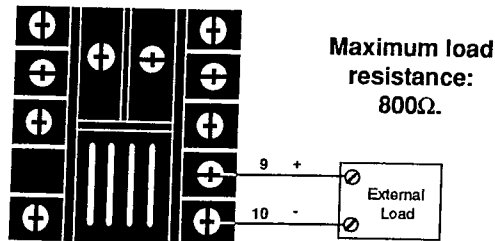
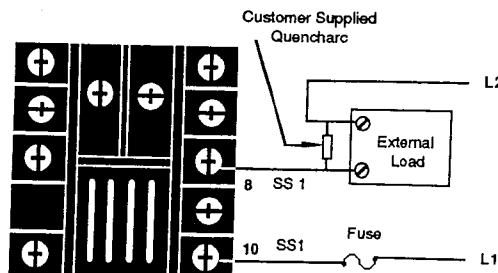

Figure 15 -
0.5 Amp Solid State
Relay Without
Contact Suppression
Wiring

Solid State Relay Without Contact Suppression, 0.5 Amp

Model # DIN-9650



NOTE:

For more information on alarms see Page 24.

DC Output (Open Collector)

Special order: Please contact D-M-E customer service

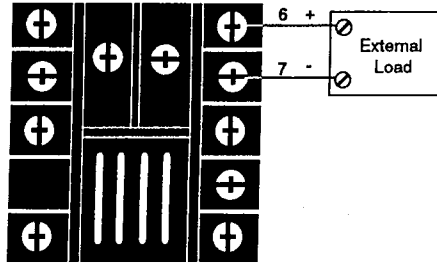

Figure 16 -
DC Output (Open
Collector) Wiring

Mechanical Relay Without Contact Suppression, Form C, 5 Amp

Model # DIN-9653

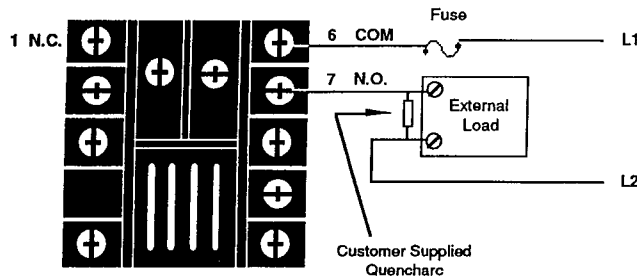

Figure 17 -
5 Amp Mechanical
Relay Wiring

NOTE:

A quencharc should be placed across all inductive loads (relay coils, solenoids, etc.)

D-M-E Part No.
DIN-0001

Solid State Relay Without Contact Suppression, 0.5 Amp

Model # DIN-9652

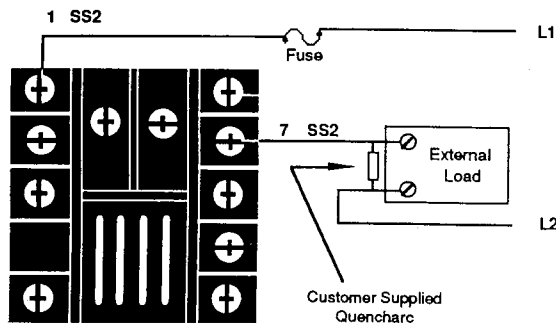

Figure 18 -
0.5 Amp Solid State
Relay Without
Contact Suppression
Wiring



WARNING:

All wiring and fusing must conform to the National Electric Code NFPA70. Contact your local board for additional information. Failure to observe NEC safety guidelines could result in injury to personnel or damage to property.

Figure 19 - System Wiring Example

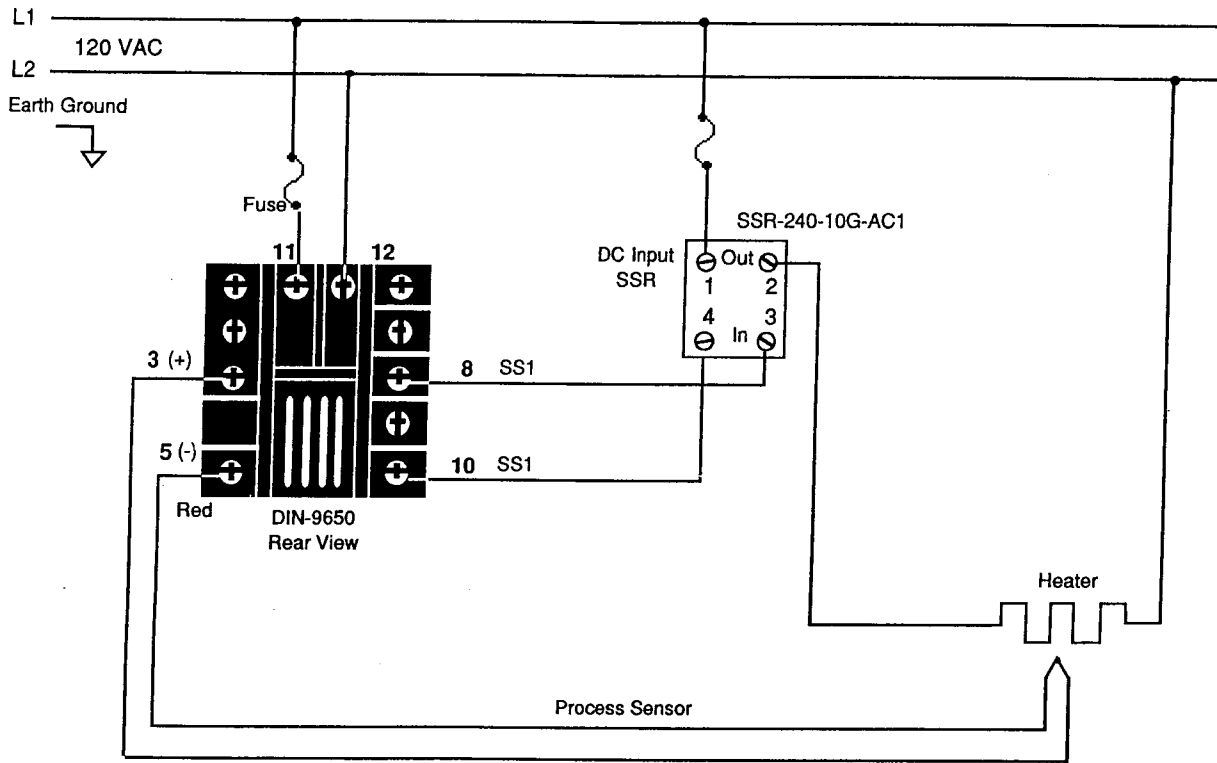

| DIN-9650 | |
|----------|-----------------|
| 1 | Not Used |
| 2 | S1, I- |
| 3 | S2, TC+, V+ |
| 4 | Not Used |
| 5 | S3, TC-, V-, I+ |
| 6 | Not Used |
| 7 | Not Used |
| 8 | SS1 1 |
| 9 | Not Used |
| 10 | SS1 1 |

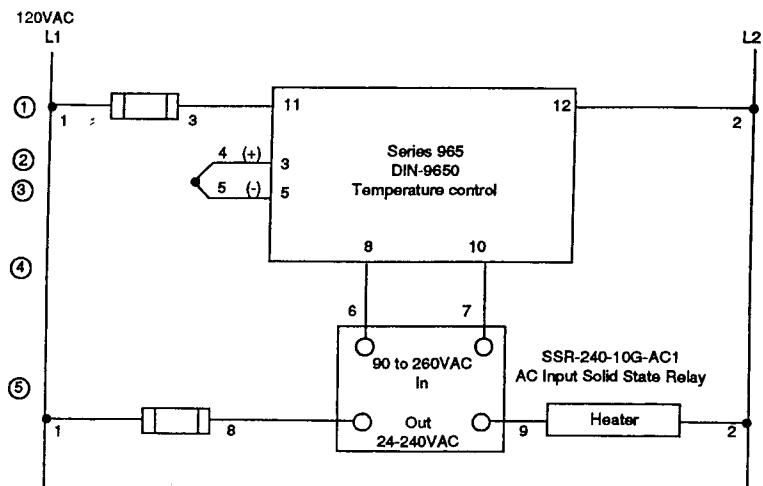

Chapter 3

How to Use the Keys and Displays

Figure 20 - Series 965 Keys and Displays

After 1 minute with no key activations, the control reverts to the process value in the upper display and the set point in the lower display.

Upper Display

Red 0.3" (8 mm) high, seven segment, four digit LED display, indicating either process actual temperature, the operating parameter values, or an open sensor. When powering up, the Process display will be blank for 5 seconds. This display can be blank by selecting SET in the dSP parameter. See Page 17.

L 1

When lit, this LED tells you when Output #1 is energized.

L 2

When lit, this LED tells you when Output #2 is active. This output can be configured as a control or alarm output.

Lower Display

Green 0.3" (8 mm) high, seven segment, four digit LED display, indicating the set point, output value, parameters for data in the upper display, or error and alarm codes. This display can be blank by selecting Pro in the dSP parameter. See Page 17.

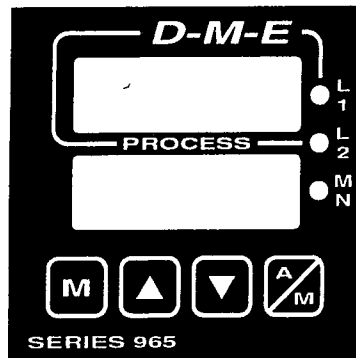

MN

Lit when the control is in Manual operation. Press the A/M key twice to enter Automatic operation. When blinking, this indicates that pressing the A/M key toggles between Auto and Manual. After 5 seconds without pressing the A/M key, the LED stops blinking, and returns to its previous state.

MODE Key

Steps the control through the Operating menu; also, in the Auto mode, new data is self entering in 5 seconds.

UP Key

Increases the value of the displayed parameter. A light touch increases the value by one. Holding the key down increases the value at a rapid rate. New data is self entering in 5 seconds.

DOWN Key

Decreases the value of the displayed parameter. A light touch decreases the value by one. Holding the key down decreases the displayed value at a rapid rate. New data is self entering in 5 seconds.

A/M Key

Pressed once, it clears any latched alarms and toggles between Auto and Manual mode. If pressed again within 5 seconds it will change from Auto to Manual or vice versa. While in Manual mode, percent power is in the lower display.

UP/DOWN Keys

When pressed simultaneously for 3 seconds, the Setup Menu appears displaying the LOC parameter. Continue to press the UP/DOWN keys, and the Calibration menu appears.

How To Setup The Series 965

Setting up the Series 965 is a simple process. First set the DIP switches to match your input type. Refer to the orientation below and Page 16 for the In parameter. Next, configure the 965's features to your application in the Setup Menu, then enter values in the Operating Menu. Both tasks use the MODE key to move through the menus and the UP/DOWN keys to select data.

Before entering information in the Setup menu, set the dFL parameter. If selected as US: rate, reset, °F and proportional band in degrees are the default. If selected as SI: integral, derivative, °C and proportional band in % of span are the default. See the Appendix in the back of this manual to change this parameter. Change **only** the dFL parameter. Changing any other parameters may alter your calibration.



WARNING:
Remove power from the control before removing the chassis from the case or changing the DIP switches.

How to Set the Input Type DIP Switch

The Series 965 input type can be user selectable at any time via a Dual In-line Package (DIP) switch inside the control, located on the left (viewed from the bottom). To set the DIP switch, remove the control chassis from the case. Holding each side of the bezel, press in firmly on the side grips until the tabs release. You may need to rock the bezel back and forth several times to release the chassis.

The location of the board and switches appear in Figure 21. Refer to the input types below for DIP switch orientation. DIP switch selection must match the sensor selected under the In parameter in the Setup menu. Set the software selection for the input type to match. See Page 16.

Figure 21 -
DIP Switch Location
and Orientation

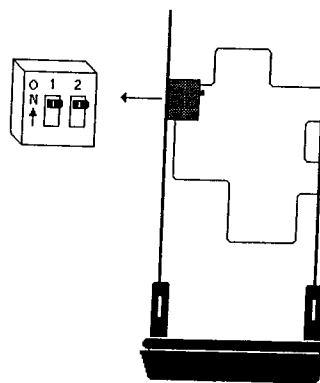

Control Chassis -
Bottom View

Input Types

Thermocouple

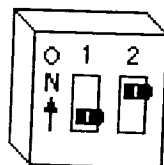

RTD

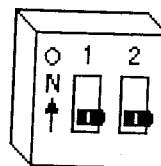

Process

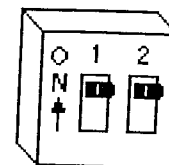

Entering the Setup Menu

The Setup Menu displays the parameters that configure the Series 965's features to your application.

Enter the Setup Menu by pressing the UP/DOWN keys simultaneously for 3 seconds. The lower display shows the LOC parameter, and the upper display shows its current level. All keys are inactive until you release both keys. You can reach the LOC parameter from anywhere.

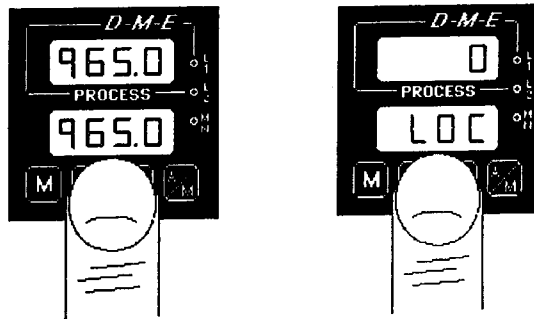
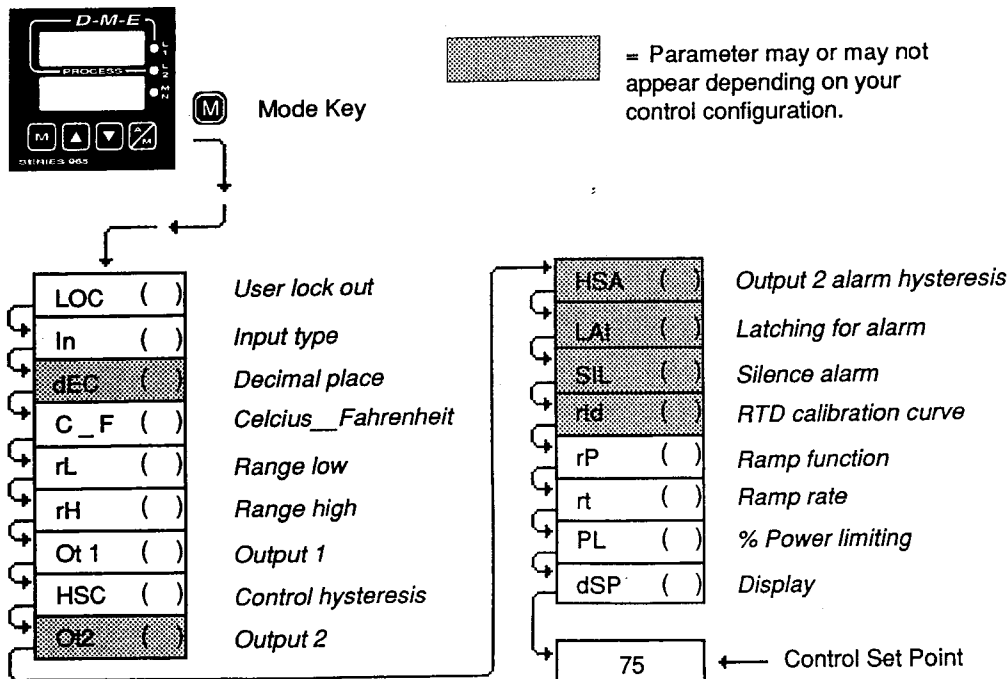

Figure 22 - Entering the Setup Menu

You will not see all parameters in this menu, depending on the unit's configuration and model number. After stepping through the menu it returns to the control set point parameter under the Operation menu.



NOTE:
While in the Setup menu, all outputs are OFF.

Figure 23 - The Setup Menu

Setup Parameters

When you are at the top of the menu, the Series 965 displays the user level of operation in the upper display, and the LOC parameter in the lower display.

Press the MODE key and the value of the next parameter appears in the upper display, and the parameter appears in the lower display.

LOC

Lock: Selects the level of operator lock-out as defined below.

Range: 0 - 4 **Default:** 0

LOC 0: All operating parameters may be viewed or changed. Manual operation **is** permitted. When in manual operation, percent power is adjustable. Bumpless transfer to manual mode can occur on sensor break.

 **NOTE:**

Process input does not have sensor break protection or bumpless transfer.

LOC 1: The set point, actual, and alarm settings are the only visible parameters, set point **is** adjustable in this level. Manual operation and auto-tune **are** permitted. When in manual operation, percent power is adjustable. Bumpless transfer to manual mode can occur on sensor break.

LOC 2: The set point, actual, and alarm settings are the only visible parameters, set point **is** adjustable in this level. Manual operation **is** permitted. When in manual operation, percent power is adjustable. Bumpless transfer to manual mode can occur on sensor break.

LOC 3: The set point and actual are the only visible parameters, set point **is** adjustable in this level. Manual operation is **not** permitted. Bumpless transfer is defeated and outputs are disabled on sensor break.

LOC 4: The set point and actual are the only visible parameters, set point is **not** adjustable in this level of lock-out. Manual operation is **not** permitted. Bumpless transfer is defeated and outputs are disabled on sensor break.

In

Input: Selects the sensor input type. The internal DIP switch must also match the In parameter. See Page 14 for DIP switch orientation, and see Page 18 for input type temperature ranges.

Range: J, K (appears as H), t, n, S, rtd, rt.d, 0-5, 420 **Default:** J

dEC

Decimal: Selects the location of the decimal point for all process related data. This parameter only appears if the In parameter is 0-5 or 420. Make sure the internal DIP switch matches the In parameter.

Range: 0, 0.0, 0.00 **Default:** 0

C_F

Celsius _ Fahrenheit: Selects the units of temperature measurement for the control. This parameter only appears if the In parameter is a thermocouple or RTD input. The default is dependent on the dFL parameter located in the Calibration menu. Refer to the Appendix. **Range:** C or F

If dFL = US: **Default:** F If dFL = SI: **Default:** C

rL

Range Low: Selects the low limit of the set point. Also used to set the low end of the process input. 0.0VDC and 4mA represent Range Low (rL) for process input. The process input is linearly scaled between rL and rH. See the model number and specification in the Appendix for range values, or refer to Table 1 on Page 18. **Range:** Sensor range low to rH

Default: Low limit of sensor type/-500 for process input

Range High: Selects the high limit of the operating range. Also used to set the high end of the process input. 5.0VDC and 20mA represent Range High (rH) for process input. The process input is linearly scaled between rL and rH. See the model number and specification information in the Appendix for your range values, or refer to Table 1 on Page 18. **Range:** Sensor range high to rL **Default:** High limit of sensor type/9999 for process input

rH

Output 1: Selects the action for the primary output. Action in response to the difference between set point and process variable. Select ht (heat) for reverse acting or select CL (cool) for direct acting. **Range:** ht, CL **Default:** ht

Ot1

Hysteresis-Control: Selects the switching hysteresis for Output 1 and 2 when you select 0 (ON/OFF) under the Pb1 parameter and Ot2 = Con. **Range:** 1 - 99, .1 - 9.9, .01 - .99 **Default:** 3, .3, .03°F

HSC

Output 2: Selects the output action for the secondary output.

Range: Con Control mode opposite Output 1 (heat or cool) **Default:** Con
 PrA Process alarm
 Pr Process alarm with no alarm message displayed
 dEA Deviation alarm
 dE Deviation alarm with no alarm message displayed
 no None

Ot2

Hysteresis - Alarm: Selects the switching hysteresis for Output 2 when Ot2 is an alarm. This parameter only appears if Ot2 ≠ Con or no. See Page 19 for the Pb1 parameter. **Range:** 1 - 9999, .1 - 999.9, .01 - 99.99 **Default:** 3, .3, .03°F

HSA

Latching: Selects whether the alarm is latching or non-latching. Latching alarms must be cleared before the alarm output will reset. Non-latching automatically resets the alarm output when the condition clears. This parameter will not appear if Ot2 = Con or no. **Range:** LA or nLA **Default:** nLA

LA

Silencing: Selects alarm silencing (inhibit) for the alarm. This parameter appears only when Ot2 = dEA or dE. For more information see Chapter 5, "Using Alarms." **Range:** On or OFF **Default:** OFF

SIL

RTD: Selects the RTD calibration curve for RTD inputs. This parameter will not appear unless In = rtd or rt.d. JIS = $0.003916\Omega/\Omega^{\circ}\text{C}$, DIN = $0.003850\Omega/\Omega^{\circ}\text{C}$. **Range:** din or JIS **Default:** din

rtd

Ramping: Choose **Str**, and the set point ramps at the selected rate in °/hr from process (actual) temperature to set point, when power is applied to the control (start up). It will not ramp with a set point change. **On** is the same as Str plus it ramps *with* a set point change. It ramps from the previous set point to a new one at the selected ramp rate. **OFF** is for no ramping action. When ramping, the lower display alternately flashes rP. The set point displayed is the desired end set point. The ramping setpoint is not shown. Entering the Setup menu or manual operation disables the outputs and ramp. Once you exit either one, the 965 controls to the last entered set point. **Range:** Str, On, OFF **Default:** OFF

rP

Rate: Selects the ramping rate in degrees per hour. This parameter will not appear if rP = OFF. **Range:** 0 to 9999 **Default:** 100°/hr

rt

Setup

PL

dSP

Power Limiting: The power limiting function in % power for heat.
Range: 0 - 100 **Default:** 100

Display: Selects which displays are active or viewable. Five seconds after selected, the appropriate display goes blank. Press MODE, UP or DOWN to override this feature and cause the current value to be displayed for 5 seconds.

Range: nor Normal displays **Default:** nor
 SEt Set Point - Lower display only
 Pro Process - Upper display only

Table 1 -
Input Ranges.

| Input Type | Sensor Range Low | Sensor Range High |
|------------------|------------------|-------------------|
| J | 32°F/0°C | 1382°F/750°C |
| K (appears as H) | -328°F/-200°C | 2282°F/1250°C |
| t | -328°F/-200°C | 662°F/350°C |
| n | 32°F/0°C | 2282°F/1250°C |
| S | 32°F/0°C | 2642°F/1450°C |
| rtd (1°) | -328°F/-200°C | 1292°F/700°C |
| rt.d (0.1°) | -199.9/199.9 | 999.9/700.0 |
| 4-20mA | 4mA/-999 units | 20mA/9999 units |
| 0-5VDC | 0VDC/-999 units | 5VDC/9999 units |

Table 2 -
Setup Menu
Prompts and
Descriptions.

Setup Menu

Use this page as a master copy for configuring your Series 965.
Do not enter any values here; make photocopies instead.

| Parameter | Value | Range | Factory Default | Appears If: |
|-----------|-------|--|-------------------|------------------------|
| LOC | | 0 - 4 | 0 | |
| In | | J, K (appears as H), t, n, S, rtd, rt.d, 0-5, 420 | J | DIP switch selectable. |
| dEC | | 0, 0.0, 0.00 | 0 | In = 0-5 or 420 |
| C_F | | C or F | Dependent on dFL. | In = T/C or RTD |
| rL | | rL to rH | Input dependent. | |
| rH | | rH to rL | Input dependent. | |
| Ot1 | | ht or CL | ht | |
| HSC | | 1 - 99, 0.1 - 9.9, 0.01 - 0.99 | 3, 0.3, 0.03°F | |
| Ot2 | | Con = Control PrA = Process Alarm Pr = Process with no alarm message dEA = Deviation alarm dE = Deviation with no alarm message no = None | Con | |
| HSA | | 1 - 9999, 0.1 - 999.9, 0.01 - 99.99 | 3, 0.3, 0.03°F | Ot2 ≠ Con or no |
| LAt | | LAt or nLA | nLA | Ot2 ≠ Con or no |
| SIL | | On or OFF | OFF | Ot2 = dEA or dE |
| rtd | | JIS or din | din | In = rtd or rt.d |
| rP | | Str = Ramping on power up on = Ramping to set point at all times OFF = None | OFF | |
| rt | | 0 to 9999 | 100°/hr | rP ≠ OFF |
| PL | | 0 to 100 | 100 | |
| dSP | | nor = normal SEt = Set Point (lower only) Pro = Process (upper only) | nor | |

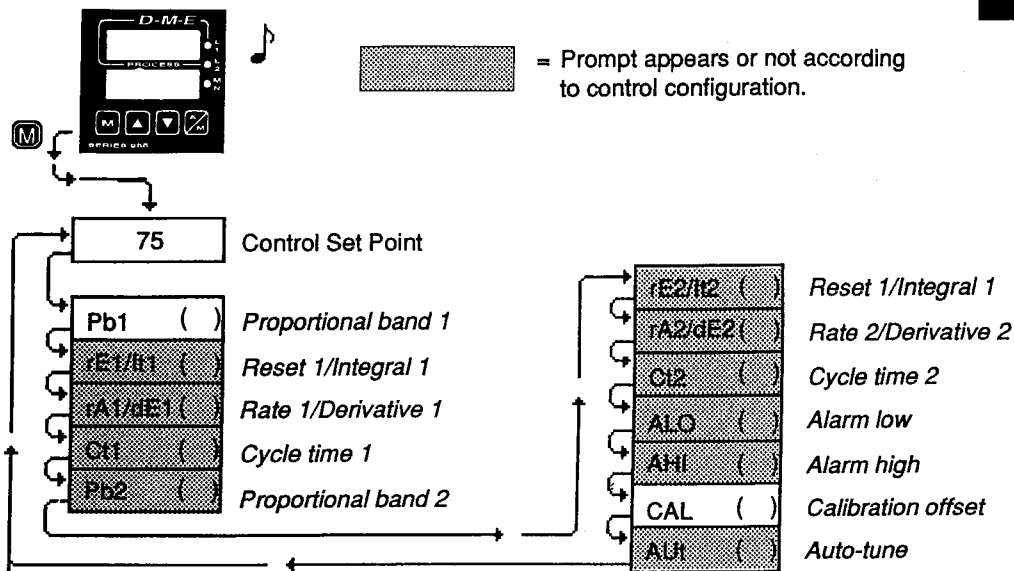

NOTE:
The upper display will always return to the process value after 1 minute without key strokes.

Figure 24 - The Operation Menu.

Operation Parameters

Set Point: Sets the operating set point for Output 1. Represents the process value the system tries to achieve for Output 1. "SP" does not appear, the control set point value will. The lower display may be blank if dSP = Pro. If in a ramping mode, the lower display alternately flashes the desired end set point and rP.

[SP]

Proportional Band 1 & 2 : A proportional band expressed in degrees or % of span, within which a proportioning function is active for Output 1 or 2. When Pb1 = 0, the unit functions as an ON/OFF control on Output 1 and 2. Pb2 will not appear if Pb1 = 0 or Ot2 ≠ Con. The switching differential is determined by the HSC parameter.

Pb1
Pb2

If dFL = US: **Range** Pb1: 0 to 999°F/0 to 555°C/0 to 999 Units; 0.0 to 9.9°F/0.0 to 5.5°C/0.0 to 9.9 units, Pb2: The same as Pb1 except lower limit is 1.

Defaults: Pb1 = 25°F/2.5°F Pb2 = 25

If dFL = SI: **Range:** 0 to 999.9% of span **Defaults:** Pb1 = 3.0% Pb2 = 3.0%

Reset /Integral 1 & 2: An integral control action for Output 1 or 2 that automatically eliminates offset, or "droop," between set point and actual process temperature. rE1/It1: Will not appear if Pb1 = 0. rE2/It2: Appears if Pb1 ≠ 0 and Ot2 = Con. Either reset (rE) or integral (It) will appear depending on how the dFL parameter is set in the Calibration menu. See Appendix II.

rE1/It1
rE2/It2

If dFL = US: **Range:** 0 to 9.99 repeats/minute **Default:** 0.00

If dFL = SI: **Range:** 00.1 to 9.99 minutes per repeat **Default:** 0.00

Rate /Derivative 1 & 2 : The rate (derivative) function for Output 1 or Output 2. Eliminate over shoot on start up, or after the set point changes. rA1/dE1: Will not appear if Pb1 = 0. rA2/dE2: Appears if Pb1 ≠ 0 and Ot2 = Con. Either rate (rA) or derivative (dE) appears depending on how dFL is set in the Calibration menu. If dFL = US or SI: **Range:** 0 to 9.99 minutes **Default:** 0.00

rA1/dE1
rA2/dE2

Cycle Time 1 & 2: Time for a controller to complete one time proportioned cycle for Output 1 or Output 2; expressed in seconds. Ct1: Will not appear if Pb1 = 0, or Output 1 is 4-20mA. Ct2: Will not appear if Pb1 = 0 or Ot2 ≠ Con. **If a mechanical relay or contactor is switching power to the load, a longer cycle time may be desirable to minimize wear on the mechanical components. Typical life of a mechanical relay is 100,000 cycles.**

Ct1
Ct2

Range: 0.1 to 999.9

Default: 10.0

Operation

ALO

Alarm Low: Represents the low process alarm or low deviation alarm. This parameter will not appear if Ot 2 = no or Con.
 If Ot2 = dEA or dE: **Range:** -999 to 0 **Default:** -999
 If Ot2 = PrA or Pr: **Range:** rL to AHl **Default:** rL

AHl

Alarm High: Represents the high process alarm or high deviation alarm. This parameter will not appear if Ot2 = no or Con.
 If Ot2 = dEA or dE: **Range:** 0 to 999 **Default:** 999
 If Ot2 = PrA or Pr: **Range:** ALO to rH **Default:** rH

CAL

Calibration Offset: Adds or subtracts degrees from the input signal.
Range: -180°F to 180°F/-100°C to 100°C/-180 units to 180 units; or -180.0°F to 180.0°F/-100.0°C to 100.0°C **Default:** 0

AUt

Auto-Tune: Initiates auto-tune.
Range: 0 = off, 1 = slow, 2 = medium, 3 = fast **Default:** 0

Table 3 -
 Operation Menu
 Prompts and
 Descriptions.

Operation Menu

Use this page as a master copy for your Series 965 Operation Parameters.
Do not enter any values here; make photocopies instead.

| Operation Parameters | Value | Range | Factory Default |
|----------------------------------|-------|---|----------------------------|
| Pb1 | | If dFL = US: 0 - 999°F/0 - 555°C/0 - 999 Units 0 - 99.9°F/0 - 55.5°C/0 - 99.9 Units 0=ON/OFF control. HSC =switch diff. If dFL = SI: 0.0 to 999.9% of span | 25°F 2.5°F 3% / 0.3% |
| rE1 | | 0.00 to 9.99 repeats/minute 0.00 = No Reset. Won't appear if Pb1 = 0 or dFL = SI. | 0.00 repeats/minute |
| It1 | | 0.0 - 99.9 minutes/rpt. 0.00 = No Integral. Won't appear if Pb1 = 0 or dFL = US. | 00.0 minutes/repeat |
| rA1 | | 0.00 to 9.99 minutes 0.00 = No Rate. Will not appear if Pb1 = 0 or dFL = SI. | 0.00 minutes |
| dE1 | | 0.00 - 9.99 minutes. 0.00 = No Derivative. Won't appear if Pb 1 = 0 or dFL = US. | 0.00 minutes |
| Ct1 | | 0.1 to 999.9 Won't appear if Pb1 = 0, or 4-20mA. | 10.0 seconds |
| Pb2 | | Same as Pb1. Pb2 lower limit = 1, 0.1, 0.01 | |
| rE2 | | Same range as rE1. | |
| It2 | | Same range as It1. | |
| rA2 | | Same range as rA1. | |
| dE2 | | Same range as dE1. | |
| Ct2 | | Same range as Ct1. | |
| ALO - Deviation dE Process Pr | | -999 to 0 rL to AHl Will not appear if Ot2 = no or Con. | -999 rL |
| AHl - Deviation dE Process Pr | | 0 to 999 ALO to rH Will not appear if Ot2 = no or Con. | 999 rH |
| CAL | | ±180°F/±100°C/±180 Units | 0 |
| AUt | | 0-3 | 0 |

Chapter 5

How to Tune and Operate

Auto-tuning (Heat and/or Cool)

The Series 965 can automatically tune the PID parameters to fit the characteristics of your particular thermal system.

The auto-tuning procedure operates on a thermal response value — slow, medium, or fast. Use the slow thermal response when your process does not need to reach set point too rapidly, or if it usually does not often exceed set point. A fast thermal response produces a rapid temperature change over a short period of time.

Once the auto-tune sequence has begun, the Output 1 heat proportional band is set to 0 and the control goes into an ON/OFF mode of control at 90% of the established set point. The displayed set point remains unchanged.

Once the control finishes "learning" the system, it returns to a standard PID control with the PID values automatically set as a result of auto-tuning. See Manual Tuning on the next page to set the cool PID parameters. Any change of the set point, while in auto-tune, re-initiates the auto-tune procedure.

NOTE:

Set the HSC parameter under the Setup menu to 3°F/2°C before auto-tuning your control.

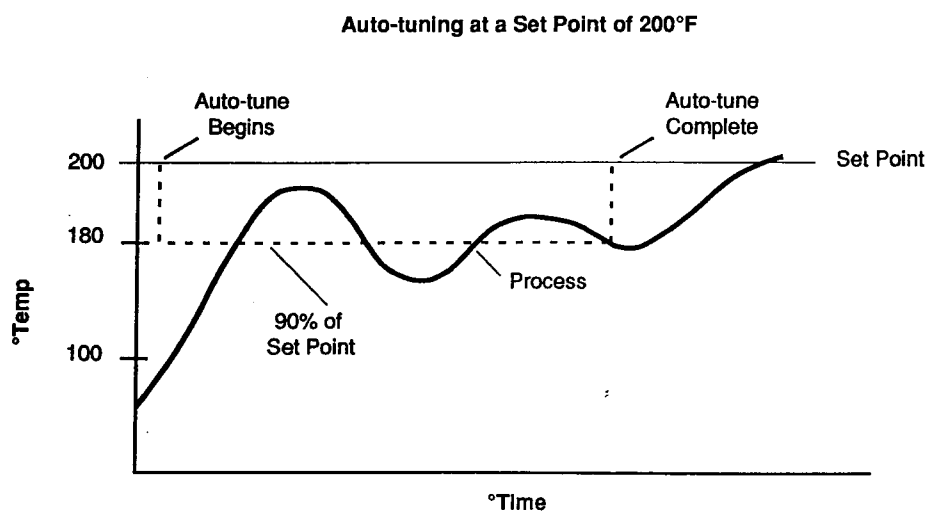

**Figure 25 -
Auto-tuning at a
Set Point of 200°F.**

In order for the 965 to successfully complete auto-tune, the process must cross 90% of set point four times within 80 minutes after auto-tune has started. If this does not happen within the 80 minute time limit, the Pb remains at 0 and the control functions in an ON/OFF mode.

To start auto-tuning:

1. Press the **MODE** key until the **AUT** prompt appears in the data display.
2. Select a thermal response value, 1=slow, 2=medium, and 3=fast, using the UP/DOWN keys. A thermal response value of 2 satisfactorily tunes most thermal systems.
3. Press the **MODE** key. While the control is in the tuning mode, the lower display alternately displays the normal information and the prompt **At**. The time between alternations is 1 second.
4. When tuning is complete, the displays return to their previous state and **AUT** reverts to 0. The 965 installs appropriate PID tuning parameters and saves them in the non-volatile memory. **If a mechanical relay or contactor is switching power to the load, a longer cycle time may be desirable to minimize wear on the mechanical components. Typical life of a mechanical relay is 100,000 cycles.**

To abort auto-tuning either reset the **AUT** parameter to 0, press the A/M key twice, or cycle power off and on. In all cases, aborting auto-tune restores all values to those previous to auto-tuning.

Manual Tuning

For optimum control performance, tune the Series 965 to your thermal system. The tuning settings here are for a broad spectrum of applications; your system may have somewhat different requirements. **NOTE: This is a slow procedure, taking from minutes to hours to obtain optimum value.**

**NOTE:**

Tune heating outputs at a set point above ambient temperature.
Tune cooling outputs at a set point below ambient temperature.

1. Apply power to the Series 965 and enter a set point. Begin with these Operation parameters: **Pb** = 1, **rE/It** = 0.00, **rA/dE1** = 0.00, **Ct** = 5.0, **CAL** = 0, **AUT** = 0.
2. **Proportional Band Adjustment:** Gradually increase **Pb** until the upper display temperature stabilizes to a constant value. The process temperature will not be right on set point because the initial reset value is 0.00 repeats per minute. (When **Pb** = 0; **rE/It** and **rA/dE1** are inoperative, and the 965 functions as a simple ON/OFF control.) The HSC parameter determines the switching differential value.
3. **Reset/Integral Adjustment:** Gradually increase **rE**, or decrease **It** until the upper display temperature begins to oscillate or "hunt." Then slowly decrease **rE** or increase **It** until the upper display stabilizes again near set point.
4. **Cycle Time Adjustment:** Set **Ct** as required. Faster cycle times sometimes achieve the best system control. However, if a mechanical contactor or solenoid is switching power to the load, a longer cycle time may be desirable

to minimize wear on the mechanical components. Experiment until the cycle time is consistent with the quality of control you want. It will not appear on units with a process output.

- 5. Rate/Derivative Adjustment:** Increase **rA/dE** to 1.00 minute. Then raise set point by 20° to 30°F, or 11° to 17°C. Observe the system's approach to set point. If the load temperature overshoots set point, increase **rA/dE** to 2.00 minutes.

Raise set point by 20 to 30°F, or 11 to 17°C and watch the approach to the new set point. If you increase **rA/dE1** too much, approach to set point is very sluggish. Repeat as necessary until the system rises to the new set point without overshooting or approaching the set point too slowly.

- 6. Calibration Offset Adjustment:** You may want your system to control to a temperature other than the value coming from the input sensor. If so, measure the difference between that temperature (perhaps at another point in the system) and the process value showing in the upper display. Then enter the **CAL** offset value you want. Calibration offset adds or subtracts degrees from the value of the input signal.

Manual and Automatic Operation

To change from auto to manual operation, press the A/M key twice.

Manual operation provides open loop control of the outputs from a range of -100% (full cooling) to 100% (full heating) power. The 965 allows a negative output value only with a CI (Cool) selection on either Ot1 or Ot2 = Con. Automatic operation provides closed loop ON/OFF or PID control. When the operator transfers from a closed loop to an open loop, the 965 retains the power level from the closed loop control, referred to as bumpless transfer. When the 965 returns to closed loop control, it restores the previous set point temperature.

The MN LED indicates auto or manual operation. When the LED is ON, the control is in manual operation. When the LED is OFF, it is in automatic operation. When the LED flashes, press the key again within five seconds to complete the change in operation.

When a sensor opens, the 965 switches from automatic to manual operation if LOC = 0, 1 or 2.

- If LOC = 0, 1 or 2 and the bumpless transfer conditions are met, process has stabilized at a $\pm 5\%$ power level for a 2 minute period prior to sensor break provided the power level is less than 75%. The 965 switches to manual operation at the last automatic power level.
- If LOC = 3 or 4, the 965 switches into manual operation at 0% power (outputs disabled).

When transferring from auto to manual operation, the control output(s) remains stable ("bumpless," smooth transition). When transferring from manual to automatic operation, the control output(s) may change significantly. In manual operation, the output value appears in the lower display, in automatic operation, the set point appears.

NOTE:

Process input does not have sensor break protection or bumpless transfer. Outputs selected as Ht (reverse acting) will be full on if sensor break occurs.

Using Alarms

NOTE:

When the alarm output is de-energized, the N.O. contact is open in the alarm condition.

The Series 965 has two alarm types, Process or Deviation. A **process alarm** sets an absolute temperature. When the process exceeds that absolute temperature limit an alarm occurs. The process alarm set points may be independently set high and low. Under the Setup menu, select the type of alarm output with the Ot2 parameter. PrA = Process Alarm Pr = Process alarm with no alarm message displayed

A **Deviation alarm** alerts the operator when the process strays too far from set point. The operator can enter independent high and low alarm settings. The reference for the deviation alarm is the set point. Any change in set point causes a corresponding shift in the deviation alarm. dEA = Deviation Alarm dE = Deviation alarm with no alarm message displayed

Example: If your set point is 100°F/38°C, and a deviation alarm is set at +7°F/4°C as the high limit, and -5°F/3°C as the low limit, the high alarm trips at 107°F/41.6°C, and the low alarm at 95°F/35°C. If you change the set point to 130°F/54.4°C, the alarms follow the set point and trip at 137°F/59°C and 125°F/51.6°C.

Under the Setup menu, select the type of alarm output with the Ot2 parameter. dEA = Deviation Alarm dE = Deviation alarm with no alarm message displayed

Both process and deviation alarms can be latching or non-latching. When the alarm condition is removed a **non-latching alarm automatically** clears the alarm output. You must **manually clear a latching alarm** before it will disappear.

Flashing "LO" or "HI" in the lower display indicates an alarm when Ot2 = PrA or dEA. The lower display alternately shows information from the current parameter and the "LO" or "HI" alarm message at one second intervals. The alarm output is de-energized and the L2 LED is lit.

To clear an alarm...

- **First correct the alarm condition, then...**
 - **If the alarm is latching...**
Clear it manually; press the A/M key once as soon as the process temperature is inside the HSA parameter alarm limit.
 - **If the alarm is non-latching...**
The alarm clears itself automatically as soon as the process temperature is inside the HSA parameter alarm limit.

Figure 26 - Alarm Display Examples

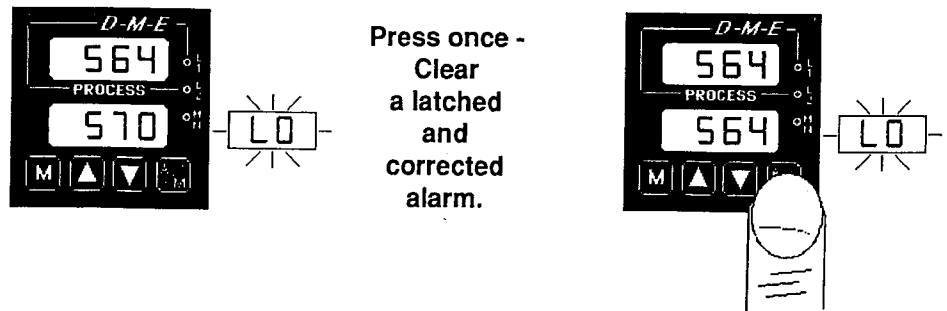

Alarm Silencing is available with the deviation alarm. When SIL is selected as "on," the operator must manually disable the alarm by pressing the A/M key once on initial power up (in either the latching or non-latching mode). Alarm silencing disables the alarm output relay. However, the L2 LED (also the lower display when Ot2 = dEA) shows an alarm condition until the process value is within the "safe" region of the deviation alarm band. Once the process value crosses into the "safe" region, both a latching or a non-latching alarm is ready. Any future deviation outside this safe band triggers an alarm.

Error Code Messages



Four dashes, "- - - -", in the upper display indicate a Series 965 error. The error code is visible in the lower display.

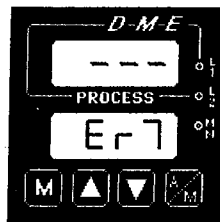

NOTE:

An alarm display will be masked by an error condition or when the control is in the Calibration or Setup Menus.

Er 2 - Sensor underrange error (only applies to RTD units)

The sensor input generated a value lower than the allowable signal range, or the A/D circuitry malfunctioned. Enter a valid input. Make sure the **In** parameter (selected in the Setup menu) and the DIP switch settings both match your sensor. Refer to the table below for the appropriate input type and range.

Er 4 - Configuration error

The unit's microprocessor is faulty; call the factory.

Er 5 - Non volatile checksum error

The nonvolatile memory checksum discovered a checksum error. Unless a momentary power interruption occurred while the unit was storing data, the nonvolatile memory is bad. Call the factory.

Er 6 - A/D underflow error

The A/D circuit is underrange. An open or reversed polarity sensor is the most likely cause. Check the sensor; if the connection is good and functions properly, call the factory. The A/D underrange voltage is too low to convert an A/D signal. Make sure the **In** parameter matches your sensor and DIP switches are set accordingly.

Er 7 - A/D overflow error

The A/D circuit is overrange. An open or reversed polarity sensor is the most likely cause. Check the sensor; if the connection is good, and the sensor functions properly, call the factory. The A/D overrange voltage is too high to convert an A/D signal. Make sure the **In** parameter matches your sensor and DIP switches are set accordingly.



CAUTION:

Electrical noise or a noise event, vibration or excess environmental moisture or temperature may cause Series 965 errors to occur. If the cause of an error is not otherwise apparent, check for these.

Error Code Actions

- **Er 2, Er 6, Er 7 result in these conditions:**

- **If operator access is LOC 0, 1 or 2 ...**

...and the control was in AUTO operation when the error occurred, it goes into manual (% power) operation. If the output power is less than 75% power, and a <5% change in power occurred within the last two minutes, the 965 switches into manual operation at the last automatic power level (bumpless transfer). If the control was in manual operation, it remains there. Press A/M twice to see the error code. The alarm output (if present) is in its alarm state (LED lit). The upper display reads "- - -". The lower display indicates the error code.

If the control was operating with stable output values when the error occurred, it continues to operate at those levels on a % power basis. If output values were not stable, the control outputs go to 0% power (OFF).

- **If operator access is LOC 3 or 4...**

The control remains in auto operation and the outputs go OFF. The A/M and MODE keys are inactive. The UP/DOWN keys may be used simultaneously to enter the Setup Menu. The alarm output (if present) is in its alarm state (LED lit). The upper display reads "- - -". The lower display indicates the error code.

- **To clear a corrected error...**

- Press M (Mode key).

- **Er 4 and Er 5 result in these conditions:**

- The control is in auto operation with both outputs OFF.
- The alarm output, if present, are in their alarm state (de-energized with the LED lit).
- The upper display indicates the process value.
- The lower display indicates the error code.
- All keys are inactive.
- All Setup Menu parameters return to default values.
- The above conditions occur regardless of the value of LOC, or the presence of the Setup or Calibration Menus.

- **To clear a corrected error...**

- Cycle power to the control.

Appendix 1

Noise and Installation Guidelines

For wiring guidelines, refer to the IEEE Standard No. 518-1982, available from IEEE, Inc. 345 East 47th Street, New York, NY 10017.

Noise Sources

- Switches and relay contacts operating inductive loads such as motors, coils, solenoids, and relays, etc.
- Thyristors or other semiconductor devices which are not zero crossover-fired (randomly-fired or phase angle-fired devices).
- All welding machinery and heavy current carrying conductors.
- Fluorescent and neon lights.

Decreasing Noise Sensitivity

- Physical separation and wire routing must be given careful consideration in planning the system layout. For example, A.C. power supply lines should be bundled together and physically kept separate from input signal lines (sensor lines). A 12" (305 mm) minimum separation is usually effective. Keep all switched output signal lines (high power level) separate from input signal lines (sensor lines). Cross other wiring at 90° angles whenever crossing lines is unavoidable.
- Look at the system layout; identify and locate electrical noise sources such as solenoids, relay contacts, motors, etc. Route the wire bundles and cables as far away as possible from these noise sources. Don't mount relays or switching devices close to a microprocessor control. Don't have phase angle-fired devices in the same electrical enclosure or on the same power line with the control.
- Shielded cables should be used for all low power signal lines to protect from magnetic and electrostatic coupling of noise. Some simple pointers are:
 - ◊ Whenever possible, run low level signal lines unbroken from signal source to the control circuit.
 - ◊ Connect the shield to the control circuit common at the control end only. Never leave the shield unconnected at both ends. Never connect both shield ends to a common or ground.
 - ◊ Maintain shield continuity at daisy chain connection points by reconnecting the broken shield.
 - ◊ Assume no electrostatic shielding when using the shield as a signal return. If you must do this, use triaxial cable (electrostatically shielded coaxial cable).

- Use twisted pair wire any time control circuit signals must travel over two feet, or when you bundle them parallel with other wires.
- Select the size or gauge of wire by calculating the maximum circuit current and choosing the gauge meeting that requirement. Using greatly larger wire sizes than required generally increases the likelihood of electrostatic (capacitance) coupling of noise.
- Eliminate ground loops in the entire control system. You can spot the obvious loops by studying the "as-built" wiring diagram. There are also not-so-obvious ground loops resulting from connecting internal circuit commons in the manufacturers equipment.
- Do not daisy chain A.C. power (or return) lines, or output signal (or return) lines to multiple control circuits. Use a direct line from the power source to each input requiring A.C. power. Avoid paralleling L1 (power lead) and L2 (return lead) to load power solenoids, contactors, and control circuits. If an application uses L1 (power lead) to switch a load, L2 (return lead) has the same switched signal and could couple unwanted noise into a control circuit.
- Tie all ground terminals together with one lead (usually green wire) tied to ground at one point. Don't connect ground to the control case if the control is in a grounded enclosure (preventing ground loops).
- Do not confuse chassis grounds (safety ground) with control circuit commons or with A.C. supply L2 (return or neutral line). Each return system wiring must be separate. Absolutely never use chassis ground (safety) as a conductor to return circuit current.

Eliminating Noise

- Use "snubbers" ("QUENCHARC™") to filter out noise generated by relays, relay contacts, solenoids, motors, etc. A snubber is a simple filter device using a 0.1 μ f, 600 volt, non-polarized capacitor in series with a 100 Ω , 1/2 watt resistor. The device can be used on A.C. or D.C. circuits to effectively dampen noise at its source.
- The ultimate protection is an "uninterruptable" power supply. This "senses" the A.C. power line; when the line fluctuates, a battery powered 60Hz inverted circuit takes over, supplying power within one-half to one cycle of the A.C. line; very expensive.

Calibration

Before attempting to calibrate, make sure you have the proper equipment called for in each procedure.

Entering the Calibration Menu

In the Calibration Menu, various input signals must be supplied for the control to go through its auto calibration. The calibration menu can only be entered from the LOC parameter in the Setup menu. Press the UP/DOWN keys simultaneously for 3 seconds (± 1 second). The CAL parameter appears in the lower display with "no" in the upper display.

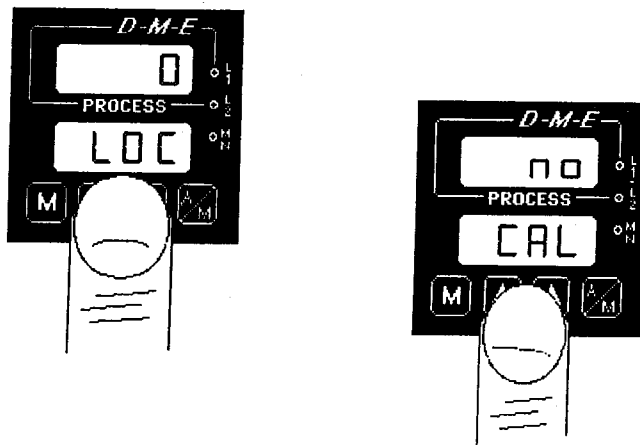

Figure 27 -
Entering the
Calibration Menu.

NOTE:

Calibration values will not be retained unless you are in the MANUAL mode. Do not enter the MANUAL mode until you are at the correct input parameters.

Any inadvertent change in the displayed data, when pressing the UP/DOWN keys, is ignored. Calibration values won't be retained unless you are in the manual mode. Press the UP/DOWN key to change the upper display to "YES." Press MODE to enter the calibration sequence.

Upon entering the calibration menu, the upper display window indicates CAL. It continues to indicate CAL (with the exception of calibration of the 4-20mA output) while the operator walks through the entire calibration parameter list. While calibrating the 4-20mA output, the upper display contains a numeric value to be slewed up or down until the output value is correct. The control uses the lower display to prompt the user as to what the input should be.

NOTE:

While in the Calibration Menu, the control output(s) go OFF and the alarm output (if present) is ON.

With the dFL parameter, select either U.S. parameters which include displaying °F, rate, reset, and proportional band in degrees or units. Or select SI (System International) and the displayed parameters are °C, integral, derivative, and proportional band in % of span.

Once the information has been properly established and maintained for at least 5 to 10 seconds, the MODE key may then be used to display the next prompt. After the final input is established, press the MODE key twice to return the unit to the configuration menu at the top of the parameter list.

Restoring Factory Calibration

The rSt parameter restores the factory calibration values to the Series 965. If you calibrate your control incorrectly, you have the option to default to the original values. Once you leave the CAL menu, the values are entered.

1. Press the UP/DOWN keys simultaneously for three seconds. The LOC parameter appears in the lower display. Continue holding the UP/DOWN keys until the lower display reads CAL.
2. Press the UP key until YES appears in the upper display.
3. MODE through the calibration menu until rSt appears in the lower display.
4. Press the UP key until YES appears in the upper display.
5. Press the MODE key and the 965 advances to test the displays.

This procedure is used only to restore calibration, it is not meant to clear values.

Calibration Menu

Figure 28 - Calibration Parameters

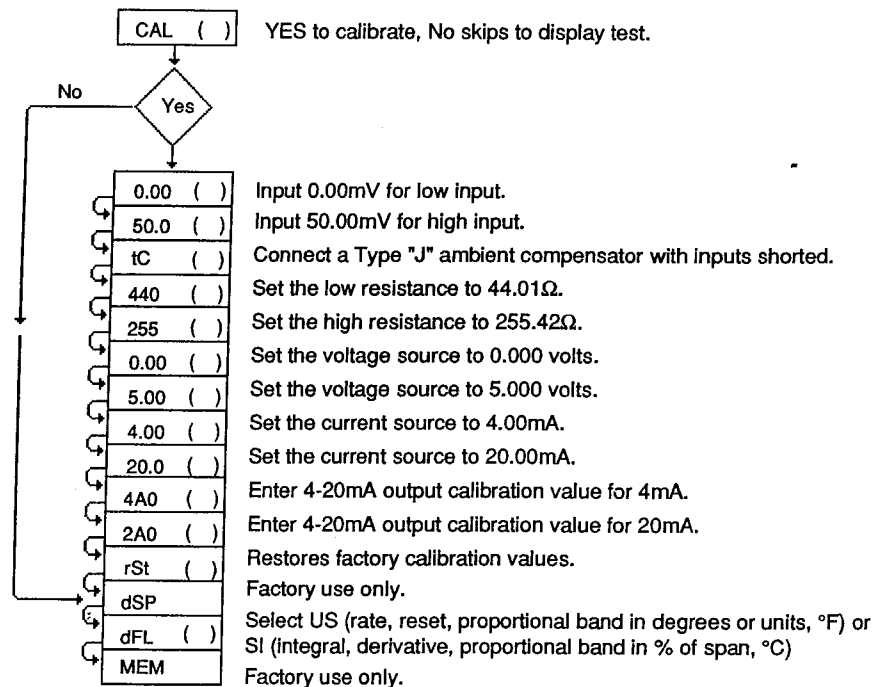

Before attempting to calibrate, make sure you have the proper equipment called for in each procedure.

The Series 965 is calibrated and tested before leaving the factory.

Equipment Required

- Type "J" Reference Compensator with reference junction at 32°F/0°C, or Type "J" Thermocouple Calibrator set at 32°F/0°C.
- Precision millivolt source, 0-50mV min. range, 0.01mV resolution

Setup And Calibration

1. Connect the AC line voltage L1 and L2 to the proper terminals.
2. Connect the millivolt source to Terminal #5 Negative and Terminal #3 Positive on the Series 965 terminal strip. Use regular 20 - 24 gauge wire. Make sure the DIP switch is set for thermocouple input, see Chapter 4.
3. Apply power to the unit and allow it to warm up for 15 minutes. **After warm-up** put the unit in the CAL menu. See Figure 27 on Page 29. Select **YES**.
-  4. Press the A/M key twice to enter the MANUAL mode. The unit is calibrating when the MN LED is ON. Make sure the unit is in MANUAL mode **only** when you are in the correct parameters.
5. At the **0.00** prompt, enter 0.00mV from the millivolt source to the control. Allow at least 10 seconds to stabilize. Press the MODE key.
6. At the **50.0** prompt, enter 50.00mV from the millivolt source to the Series 965. Allow at least 10 seconds to stabilize. Press the MODE key.
7. At the **tC** prompt, disconnect the millivolt source, and connect the reference compensator or T/C calibrator to Terminal #5 Negative, and Terminal #3 Positive on the Series 965 terminal strip. If using a compensator, turn on and short the input wires. If using "J" calibrator, set to simulate 32°F/0°C. Allow 10 seconds for the control to stabilize. The unit will leave the CAL mode if 1 minute passes between key activations. To conclude the T/C calibration, advance the MODE key to the next prompt or exit the CAL menu. Press the A/M key twice to exit the MANUAL mode.

NOTE

Before calibration on an installed control, make sure all data and parameters are documented. See Setup and Operation Tables, Pages 18 and 20.

NOTE:

When the MN LED is ON the unit is automatically calibrating. Your sequence is **VERY** important. Always move to the next parameter before changing the calibration equipment.

RTD Field Calibration Procedure

Equipment Required

- 1K Ω precision decade resistance box with 0.01 Ω resolution.

Setup And Calibration

1. Connect the AC line voltage L1 and L2 to the proper terminals.
2. Connect the decade resistance box to Terminal #2, 3 and 5 on the terminal strip. Use regular 20 - 24 gauge wire of the same length and type. Make sure the DIP switch is set for RTD input, see Chapter 4.
3. Apply power to the unit and allow it to warm up for 15 minutes. **After warm-up** put the unit in the CAL menu. See Figure 27 on Page 29. Select **YES**. Press the MODE key until the **440** prompt is displayed.
-  4. Press the A/M key twice to enter the MANUAL mode. The unit is calibrating when the MN LED is ON. Make sure the unit is in MANUAL mode **only** when you are in the correct parameters.
5. At the **440** prompt, set the decade resistance box to 44.01. Allow at least 10 seconds to stabilize. Press the A/M key twice to exit the MANUAL mode. The unit will leave the CAL mode if 1 minute passes between key activations. To conclude the RTD calibration, advance the MODE key to the next prompt or exit the CAL menu.
6. At the **255** prompt, set the decade resistance box to 255.42. Allow at least 10 seconds to stabilize. Press the MODE key.

0 - 5 Volt Input Field Calibration Procedure

NOTE

Before calibration on an installed control, make sure all data and parameters are documented. See Setup and Operation Charts, Pages 18 and 20.

Equipment Required:

- Precision voltage source 0-5 volt minimum range with 0.001 volt resolution.

Setup and Calibration

1. Connect the AC line voltage L1 and L2 to the proper terminals on the 965.
2. Connect the voltage/current source to Terminal #3 (+) and #5 (-) on the Series 965 terminal strip. Use regular 20 - 24 gauge wire. Make sure the DIP switch is set for process input, see Chapter 4.
3. Apply power to the unit and allow it to warm up for 15 minutes. **After warm-up** put the unit in the CAL menu. See Figure 27 on Page 29. Select **YES**. Press the MODE key until 0.00 is displayed.
4.  Press A/M twice to enter the MANUAL mode. The unit is calibrating when the MN LED is ON. Make sure the unit is in the MANUAL mode **only** when you are in the correct parameters. See Figure 28.
5. At the 0.00 parameter, set the voltage source to 0.000 volts. Allow at least 10 seconds to stabilize. Press the MODE key.
6. At the 5.00 parameter, set the voltage source to 5.000 volts. Allow at least 10 seconds to stabilize. The unit leaves the CAL mode if 1 minute passes between key activations. Press A/M twice to exit the MANUAL mode. To conclude the 0-5 Volt calibration, advance the MODE key to the next prompt or exit the CAL menu.

NOTE:

When the MN LED is ON the unit is automatically calibrating. Your sequence is VERY important. Always move to the next parameter before changing the calibration equipment.

4 - 20mA Input Field Calibration Procedure

Equipment Required:

- Precision current source 0-20mA minimum range with 0.01mA resolution.

Setup and Calibration

1. Connect the AC line voltage L1 and L2 to the proper terminals on the 965.
2. Connect the current source to Terminal #2 (-) and #5 (+) on the Series 965 terminal strip. Use regular 20 - 24 gauge wire. Make sure the DIP switch is set for process input, see Chapter 4.
3. Apply power to the unit and allow it to warm up for 15 minutes. **After warm-up** put the unit in the CAL menu. See Figure 27 on Page 29. Select **YES**. Press the MODE key until 4 is displayed.
4.  Press A/M twice to enter the MANUAL mode. The unit is calibrating when the MN LED is ON. Make sure the unit is in the MANUAL mode. **only** when you are in the correct parameters. See Figure 28 on Page 30.
5. At the 4.00 parameter, set the current source to 4.00mA. Allow at least 10 seconds to stabilize. Press the MODE key.
6. At the 20.0 parameter, set the current source to 20.00mA. Allow at least 10 seconds to stabilize. The unit leaves the CAL mode if 1 minute passes between key activations. Press A/M twice to exit the MANUAL mode. To conclude, advance the MODE key to the next prompt or exit the CAL menu.

4-20mA Output Field Calibration Procedure

Equipment Required

- 300 Ω , 1/2 watt 10% resistor.
- 4 - 1/2 digit Digital Multimeter.

Setup And Calibration

1. Connect the AC line voltage L1 and L2 to the proper terminals of the 965. See Chapter 2. Set the multimeter to measure current.
2. Connect the multimeter in series with the 300 Ω resistor to Terminal #9 Positive and #10 Negative on the Series 965 terminal strip. Use regular 20 - 24 gauge wire.
3. Apply power to the unit and allow it to warm up for 15 minutes. After warm-up put the unit in the CAL menu. Press the MODE key until the 4A0 prompt is displayed.
4. Press the A/M key twice to enter the MANUAL mode. The unit is calibrating when the MANUAL LED is ON.
5. At the 4A0 prompt, the multimeter should read approximately 4mA. Allow at least 10 seconds to stabilize.
6. Use the UP/DOWN keys (reverse acting) to adjust the reading on the multimeter for 3.85mA \pm 0.10mA. Press the MODE key.
7. At the 2A0 prompt, the multimeter should read approximately 20mA. Allow at least 10 seconds to stabilize. The unit will leave the CAL mode if 1 minute passes between key activations except for 4-20mA units.
8. Use the UP/DOWN keys (reverse acting) to adjust the reading on the multimeter for 20.15mA \pm 0.10mA.
9. To conclude the 4-20mA output calibration, advance the MODE key to the next prompt or exit the CAL menu.

NOTE

Before calibration on an installed control, make sure all data and parameters are documented. See Setup and Operation Charts, Pages 18 and 20.

NOTE:

When the MN LED is ON the unit is automatically calibrating. Your sequence is VERY important. Always move to the next parameter before changing the calibration equipment.

Alarm: A condition, generated by a controller, indicating that the process has exceeded or fallen below the set or limit point.

Alarm Silence: Disables the alarm relay output.

Anti-reset: Control feature that inhibits automatic reset action outside the proportional band.

Automatic prompts: Data entry points where a microprocessor-based control "prompts" or asks the operator/programmer for information input.

Auto-tune: Automatically tunes the Series 965 PID parameters to fit the characteristics of your particular thermal system.

Bumpless transfer: When transferring from auto to manual operation, the control output(s) will not change ("bumpless," smooth transition).

Closed loop: Control system that has a sensing device for process variable feedback.

Cold junction: Point of connection between thermocouple metals and the electronic instrument.

Cold junction compensation: Electronic means to compensate for the effective temperature at the cold junction.

Cycle time: The time necessary to complete a full ON-through-OFF period in a time proportioning control system.

Derivative: Anticipatory action that senses the rate of change of the process, and compensates to minimize overshoot and undershoot. Also "rate."

Deviation alarm: An alarm referenced at a fixed number of degrees, plus or minus, from set point.

Default parameters: The parameters, or programmed instructions, permanently stored in microprocessor software to provide a data base.

DIN: Deutsche Industrial Norms, a widely-recognized German standard for engineering units.

Display capability: In a digital indicating instrument, the entire possible span of a particular parameter or value.

Droop: Difference in temperature between set point and stabilized process temperature.

Duty cycle: Percentage of "load ON time" relative to total cycle time.

Hysteresis: In ON/OFF control, the temperature change necessary to change the output from full ON to full OFF.

Hunting: Oscillation or fluctuation of process temperature between set point and process variable.

Input: Process variable information being supplied to the instrument.

Integral: Control action that automatically eliminates offset, or "droop," between set point and actual process temperature. Also "reset."

Isolation: Electrical separation of sensor from high voltage circuitry. Allows for application of grounded or ungrounded sensing element.

JIS: Joint Industrial Standards. Also Japanese Industrial Standards Committee (JISC). Establishes standards on equipment and components.

Offset: Adjustment to actual input temperature and to the temperature values the Series 965 uses for display and control.

ON/OFF control: Control of temperature about a set point by turning the output full ON below set point and full OFF above set point in the heat mode.

Open loop: Control system with no sensory feedback.

Output: Action in response to difference between set point and process variable.

Overshoot: Condition where temperature exceeds setpoint due to initial power up or process changes.

P control: Proportioning control.

Parameter: A physical property whose value determines the response of an electronic control to given inputs.

PD control: Proportioning control with rate action.

PI control: Proportioning control with auto-reset.

PID control: Proportioning control with auto-reset and rate.

Process variable: Thermal system element to be regulated, such as time, temperature, relative humidity, etc.

Programmed display data: Displayed information which gives the operator/programmer the "programmed" or intended process information, i.e., intended set point, intended alarm limit, etc. See "Actual displayed data."

Proportional band: Span of temperature about the set point where time proportional control action takes place.

Proportioning control: See Time Proportioning Control.

Rate: Anticipatory action that senses the rate of change of temperature and compensates to minimize overshoot. Also "derivative."

Rate Band: A thermal control band that defines where the rate (derivative) function begins. A Watlow rate band occurs centered on set point at one or more times the width of the proportional band.

Reference junction: Synonymous with cold junction. See "Cold junction."

Reset: Control action that automatically eliminates offset, or "droop," between set point and actual process temperature. Also "integral."

Reset windup inhibit: Synonymous with anti-reset. See "Anti-reset."

RTD: Resistance Temperature Detector. Resistive sensing device displaying resistance versus temperature characteristics. Displays positive temperature coefficient.

Set point: Intended value of the process variable.

Switching sensitivity: In ON/OFF control, the temperature change necessary to change the output from full ON to full OFF.

Thermal system: A regulated environment consisting of a heat source, heat transfer medium, sensing device and a process variable control instrument.

Thermocouple: Temperature sensing device that is constructed of two dissimilar metals wherein a measurable, predictable voltage is generated corresponding to temperature.

Thermocouple break protection: Fail-safe operation that assures output shutdown upon an open thermocouple condition.

Three mode control: Proportioning control with reset and rate.

Time Proportioning Control: Action which varies the amount of ON and OFF time when "close" to the set point, i.e., in the proportional band. This variance is proportional to the difference between the set point and the actual process temperature. In other words, the amount of time the output relay is energized depends on the system temperature.

Triac: Solid state switching device.

Upper display data: Displayed information which gives the operator/programmer real or "actual" data, i.e., actual process temperature. See "Programmed display data."

Warm Start: Start-up condition where all program information is remembered by the instrument's memory back-up protection.

Zero switching: Action that provides output switching only at the zero voltage crossing points of the AC line.

A

Alarms, 24
 Wiring, 11
Appendix, 27
A/M key, 13
Automatic Operation, 13, 23
Auto-tuning, 21

B

Bumpless transfer, 23

C

Calibration, 29

D

DC Output 1, 10
DC Output 2, 11
Default Parameters,
 Operation, 20
 Setup, 18
Dimensions,
 Faceplate 5
 Panel Cutout, 5
 Sideview, 5
PID Switches, 14
Displays, 13, 17
DOWN key, 13

E

Eliminate Noise, 28
Entering the Setup Menu, 15
Error Codes, 25

F, G

General Description, 4
Glossary, 34

H

High Voltage Wiring, 7
Hysteresis, 17

I

Input,
 Wiring, 8
 DIP Switch, 14
 Ranges, 18
Input/Installation, 5

J, K

Keys, 13

L

L1 & L2 LEDs, 13
Ladder Wiring Diagram, System, 12
Lock Parameter, 16
Low Voltage Wiring, 7
Lower Display, 13

M

M/N Key, 13
Manual Operation, 13, 23
Manual Tuning, 22
Mechanical Relay, 5 Amp,
 Output 1 Wiring, 10
 Output 2 Wiring, 11
MODE key, 13
Model Number, 39

N

Noise,
 Eliminating, 28
 Sources, 27
 Decreasing Sensitivity, 27

O

Operation Parameters, 19
Output Wiring,
 5A Mechanical Relay, 10 & 11
 4-20mA, 10
 DC (Open Collector), 10 & 11
 Solid State Relay w/o Supp., 10 & 11
Overview of the Series 965, 4

P

Power Limiting, 17
Power Wiring, 7
Process Input, 8 & 9
Process Output, 10

Q

Quick Reference Sheet, 41

R

Ramping, 17
Rate, 17
Restoring Calibration, 30
Returns, 37
RTD Calibration, 31
RTD Sensor Wiring, 9

S

Sensor Wiring, 8
Series 965 Input And Output Overview, 4
Setup Menu and Parameters, 15
Specifications, 38
System Wiring Example, 12

T

Thermocouple Break Protection, 7, 8, 16, 23
Thermocouple Calibration, 31
Thermocouple Sensor Wiring, 8
Tuning, 21

U, V, W

UP/DOWN keys, 13
Upper Display, 13
Warranty, 37

Warranty

The D-M-E Series 965 is warranted to be free of defects in material and workmanship for 36 months after delivery to the first purchaser for use, providing that the units have not been misapplied. Since D-M-E has no control over their use, and sometimes misuse, we cannot guarantee against failure. D-M-E's obligations hereunder, at D-M-E's option, are limited to replacement, repair or refund of purchase price, and parts which upon examination prove to be defective within the warranty period specified. This warranty does not apply to damage resulting from transportation, alteration, misuse, or abuse.

Returns

1. Call D-M-E Customer Service, 1-800-626-6653, for a return authorization before sending any item in for repair. We need this information:
 - Ship to address
 - Bill to address
 - Contact name
 - Phone number
 - Ship via
 - Your P.O. number
 - Symptoms and/or special instructions
 - Name and phone number of person returning the material.
2. Prior approval a return authorization, from the Customer Service Department, is needed when returning any product. Ship on a Freight Prepaid basis.
3. After we receive your return, we will examine it and determine the necessary action.
4. In cases of manufacturing defect, we will enter a repair order, replacement order, or issue credit for material. A 10 percent restocking charge is applied for all returned stock controls and accessories if they are in new condition.
5. If the unit is unrepairable, it will be returned to you so noted.

D-M-E Company

D-M-E Company is a division of Fairchild Corporation. D-M-E is the largest manufacturer of injection molding tooling in the world. The Series 965 controller is just one of a host of injection molding temperature controls products offered by D-M-E.

D-M-E offers a broad range of products for the mold designer, mold builder and injection molder. D-M-E also offers tooling and controls for the die cast industry.

For support around the world, D-M-E is your best choice. With sales offices in over 25 countries and representatives in even more, D-M-E offers sales and service in over 60 countries around the globe.

For further information on our company and products, please contact D-M-E Customer Service at 1-800-626-6653. On the west coast, call 1-213-263-9261. In Canada call 1-416-677-6370. In Europe call (32) (15) 215011 to get further information on your closest sales and service representative. In the far east, call our Hong Kong office at (852) 7951035 for the same.

Specifications

Control Mode

- Microprocessor-based, user selectable control modes
- Single input, dual output
- Ramp to set point: 0 to 9999° or units per hour
- Heat or cool auto-tune
- Output #1: User selectable as:
 - ON/OFF: P, PI, PD, PID, heat or cool action
 - Adjustable switching differential: 1 to 99°F/1 to 55°C
 - Proportional band: 0 to 500°F/0 to 278°C or 0.0 to 999.9 % of span.
 - Integral: 0 and 00.1 to 99.9 minutes per repeat
 - Reset: 0.00 to 9.99 repeats per minute
 - Derivative/Rate: 0.00 to 9.99 minutes
 - Cycle time: 0.1 to 999.9 seconds
- Output #2: User selectable as:
 - Control with action opposite that of Output 1 (heating or cooling)
 - Process or deviation alarm with flashing alarm message
 - Process or deviation alarm without alarm message
 - Alarm with separate high and low set points
 - Hysteresis: 1 to 9999° or units switching differential

Operator Interface

- Sealed membrane front panel
- Dual, four-digit red and green displays
- MODE, INCREMENT, DECREMENT, and AUTO/MANUAL keys
- User selectable screen display

Sensor Input

- Sensor input sampling rate: 2.5 samples/second, 2.5Hz
- Thermocouple, grounded or ungrounded sensors
- RTD 2 or 3 wire, platinum, 100 @ 0°C calibration to JIS curve(0.003916Ω/Ω/°C) or DIN curve (0.00385Ω/Ω/°C)
- Process, 0-20mA, or 0-5VDC, 5Ω input impedance
- Sensor break protection de-energizes control output to protect system or selectable bumpless transfer to manual operation
- °F or °C or process units display, user selectable
- Sensor operating ranges

| | | | |
|-----------|-------------------------|----|--------------------|
| J t/c: | 32 to 1382°F | or | 0 to 750°C |
| K t/c: | -328 to 2282°F | or | -200 to 1250°C |
| T t/c: | -328 to 662°F | or | -200 to 350°C |
| N t/c: | 32 to 2282°F | or | 0 to 1250°C |
| S t/c: | 32 to 2642°F | or | 0 to 1450°C |
| 1° RTD: | -328 to 1292°F | or | -200 to 700°C |
| 0.1° RTD: | -199.9 to 999.9°F | or | -199.9 to 700.0°C |
| Process: | 0mA to 20mA | or | -999 to 9999 units |
| | (calibrated for 4-20mA) | | |
| Process: | 0VDC to 5VDC | or | -999 to 9999 units |

Primary Control Output (Heating or Cooling)

- Output update rate: 1/second (1Hz)
- Output response time: 0.1 second for time proportioned outputs; 0.63 second for one time constant (0.707 of a full scale response) on process outputs.
- Solid state relay, 0.5A @ 24VAC min., 264VAC max., opto isolated zero cross switched; no contact suppression (snubber); for resistive loads only; OFF state impedance of 31MΩ.
- Electromechanical relay, Form C, 5 amps @ 120/250VAC maximum, rated resistive load, 5A @ 30VDC.

- Open collector, switched DC signal provides a minimum turn ON voltage of 3VDC into a minimum 500Ω load; maximum ON voltage not greater than 32 VDC into an infinite load.
- 4-20mA reverse (heat) or direct (cool) acting, non-isolated 0 to 800Ω load.

Secondary Control Output (Heat, Cool or Alarm)

- Output update rate: 1/second (1Hz)
- Output response time: 0.1 second for time proportioned outputs; 0.63 second for one time constant (0.707 of a full scale response) on process outputs.
- Solid state relay, 0.5A @ 24VAC min., 264VAC max., opto isolated zero cross switched; no contact suppression (snubber); for resistive loads only; OFF state impedance of 31MΩ.
- Electromechanical relay, Form C, 5 amps @ 120/250VAC maximum, rated resistive load, 5A @ 30VDC.
- Open collector, switched DC signal provides a minimum turn ON voltage of 3VDC into a minimum 500Ω load; maximum ON voltage not greater than 32 VDC into an infinite load.
- Alarm output can be latching or non-latching, and process or deviation with separate high and low values. Alarm silencing (inhibit) on power up.

Accuracy

- Calibration accuracy & sensor conformity: ± 0.1% of span, ± 1 LSD @ 77°F ± 5°F (25°C ± 3°C) ambient ± 5°F, & rated line voltage ± 10%
- Accuracy span: 1000°F (540°C) minimum
- Temperature stability: ± 0.2°F/°F ± 0.2°C/°C rise in ambient maximum excluding type "S" thermocouple input which is ± 0.3°F/°F typical, ± 1°F/°F maximum.
- Voltage stability: ± 0.01% of span per percent of rated line voltage.

Agency Approvals

- UL recognized, File #E43684, UL873
- CSA certified, File LR30586, C22.2, #24-1984
- NEMA 4X rating

Terminals

- #6 compression universal head screw terminals, accepts 20-14 gauge wire

Power

- 100-240VAC, -15%, +10%; (85 - 264VAC); 50/60Hz, ±5%
- 12-24VAC, -15%, +10%; (10 - 26VAC) 50/60Hz, ±5% or VDC
- 5VA typical power consumption
- Data retention upon power failure via nonvolatile memory

Operating Environment

- 32 to 149°F (0 to 65°C)
- 0 to 90% RH, non-condensing
- Storage temperate: -40° to 158°F (-40° to 70°C)

Dimensions

- Height: 53 mm
- Width: 53 mm
- Overall depth: 119 mm
- Behind panel depth: 104 mm
- Weight: 0.5 lb. or 0.2 kg.

Series 965 Model Number Information

The Series 965 Model Number, listed on your unit sticker, is defined below.

Microprocessor-based
1/16 DIN, single universal input,
dual output, four digit displays

Model Numbers

- DIN-9650: Single solid state relay output
- DIN-9651: Single mechanical relay output, form C
- DIN-9652: Dual solid state relay output
- DIN-9653: Dual mechanical relay output, form C

All of the above standard units have 100 to 240VAC input power supplies. All have red upper (process) and green lower (set point) displays. Custom configurations can include open collector or 4-20mA outputs, 12 to 24VAC or VDC input power supplies and different display color configurations.

Note: If these outputs drive a solenoid, MDR, contactor or other inductive device, order a Quencharc™ (DIN-0001) for output protection.
See Chapter 2 for wiring.

Spare Parts

- DIN-0001 Quencharc™ snubber
- DIN-0005 1/4 DIN to 1/16 DIN control adapter plate
- DIN-0006 1/8 DIN to 1/16 DIN control adapter plate
- DIN-0007 B/C 520 to 1/16 DIN control adapter plate

Use this page as a quick reference for the Series 965. Tear along the perforation.

Keys & Displays

Upper Display: Red or green, LED display, indicating either process actual temperature, the operating parameter values, or an open sensor.

Lower Display: Red or green, four digit LED display, indicating the set point, output value, parameters for data in the upper display, or error and alarm codes.

MODE Key: Steps the control through the operating menu, also, in the Auto mode, new data is self entering in 5 seconds.

UP Key: Increases the value of the displayed parameter. New data is self entering in 5 seconds.

DOWN Key: Decreases the value of the displayed parameter. New data is self entering in 5 seconds.

UP/DOWN Keys: When pressed simultaneously for 3 seconds, the Setup Menu appears displaying the LOC parameter. Continue to press the UP/DOWN keys, and the Calibration menu appears.

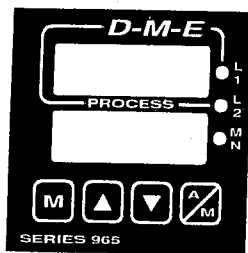

L1: When lit it indicates Output #1 is energized.

L2: When lit it indicates when Output #2 is active. This output can be configured as a control or alarm output.

MN: Lit when in manual operation. Press A/M twice to enter Automatic. When blinking, press A/M to toggle between Auto and Manual. After 5 seconds without key activations it returns to its previous state.

A/M Key: Press once to clear latched alarms and toggles between Auto and Manual. If pressed within 5 seconds it changes from Auto to Manual or vice versa. While in Manual, percent power is in the lower display.

Alarms

Process Alarm sets an absolute temperature. When the process exceeds that absolute temperature limit an alarm occurs. The process alarm set points may be independently set high and low. Under the Setup menu, select the type of alarm output with the Ot2 parameter. PrA = Process alarm
Pr = Process alarm with no alarm message displayed

Deviation Alarm: Alerts the operator when the process strays too far from set point. The operator can enter independent high and low alarm settings. The reference for a deviation alarm is set point. Any change in set point causes a corresponding shift in the deviation alarm. Under the Setup menu, select the type of alarm output with the Ot2 parameter.
dEA = Deviation alarm
dE = Deviation alarm with no alarm message displayed

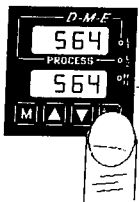

Press once to clear a latched and corrected alarm.



the deviation alarm band. Once the process value crosses into the "safe" region, both a latching or a non-latching alarm is ready. Any future deviation outside this safe band triggers an alarm. Both alarms can be latching or non-latching. When the alarm condition is removed a non-latching alarm automatically clears the alarm output. You must manually clear a latching alarm before it will disappear.

Flashing LO or HI in the lower display indicates an alarm when Ot2 = PrA or dEA. The lower display alternately shows information from the current parameter and a LO or HI alarm message at one second intervals. The alarm output is de-energized, L2 is lit.

Alarm Silencing is available with the deviation alarm. When SIL is selected as "on," the operator must manually disable the alarm by pressing the A/M key once on initial power up (in either the latching or non-latching mode). Alarm silencing disables the alarm output relay. However, the L2 LED (also the lower display when Ot2 = dEA) shows an alarm condition until the process value is within the "safe" region of

To clear an alarm...

- First correct the alarm condition, then...
 - If the alarm is latching...
Clear it manually; press the A/M key once as soon as the process temperature is inside the HSA parameter alarm limit.
 - If the alarm is non-latching...
The alarm clears itself automatically as soon as the process temperature is inside the HSA parameter alarm limit.

Error Codes

Four dashes, "- - - -" or a negative number, in the upper display indicate a Series 965 error. The error code is visible in the lower display.

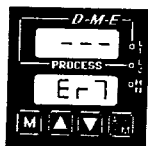

Er 2 - Sensor underrange error (For RTD units only)

The sensor input generated a value lower than the allowable signal range, or the A/D circuitry malfunctioned. Enter a valid input. Make sure the In parameter matches your sensor and DIP switch setting. Refer to the table below for the appropriate input type and range.

Er 4 - Configuration error

The unit's microprocessor is faulty; call the factory.

Er 5 - Non volatile checksum error

The nonvolatile memory checksum discovered a checksum error. Unless a momentary power interruption occurred while the unit was storing data, the nonvolatile memory is bad. Call the factory.

Er 6 - A/D underflow error

The A/D circuit is underrange. An open or reversed polarity sensor is the most likely cause. Check the sensor; if the connection is good and functions properly, call the factory. The A/D underrange voltage is too low to convert an A/D signal. Make sure the In parameter matches your sensor and the DIP switches are set accordingly.

Er 7 - A/D overflow error

The A/D circuit is overrange. An open or reversed polarity sensor is the most likely cause. Check the sensor; if the connection is good and the sensor functions properly, call the factory. The A/D overrange voltage is too high to convert an A/D signal. Make sure the In parameter matches your sensor and the DIP switches are set accordingly.

Entering the Setup Menu

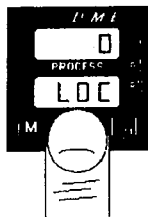
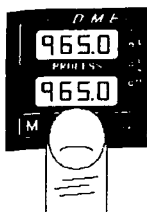

The Setup Menu displays the parameters that configure the Series 965's features to your application.

Enter the Setup menu by pressing the UP/DOWN keys simultaneously for 3 seconds. The lower display shows the LOC parameter, and the upper display shows its current level. All keys are inactive until you release both keys. You can reach the LOC parameter from anywhere.

You will not see all parameters in these menus depending on your unit's configuration and model number.

Setup Menu

Do not enter any values here; make photocopies instead.

| Parameters | Value | Range | Factory Default | Appears If: |
|------------|-------|--|-----------------|-----------------------------|
| LOC | | 0 through 4 | 0 | |
| In | | J, K (appears as H), t, n, S, rtd, rt.d, 0-5, 420 | J | DIP switch selectable |
| dEC | | 0, 0.0, 0.00 | 0 | In = 0-5 or 420 |
| C_F | | C or F | C | dFL = SI or In = T/C or RTD |
| | | | F | dFL = US or In = T/C or RTD |
| rL | | rL to rH | Input dependent | |
| rH | | rH to rL | Input dependent | |
| Ot1 | | ht or CL | ht | |
| HSC | | 1 to 99, 0.1 - 9.9, 0.01 - 0.99 | 3, 0.3, 0.03°F | |
| Ot2 | | Con = Control PrA = Process alarm Pr = Process with no alarm message dEA = Deviation alarm dE = Deviation with no alarm message no = None | Con | |
| HSA | | 1 to 9999, 0.1 - 999.9, 0.01 - 99.99 | 3, 0.3, 0.03°F | Ot2 ≠ Con or no |
| LA | | LA or nLA | nLA | Ot2 ≠ Con or no |
| SIL | | On or OFF | OFF | Ot2 = dEA or dE |
| rtd | | JIS or din | din | In = rtd or rt.d |
| rP | | Str = Ramping on power up on = Ramping to set point at all times OFF = None | OFF | |
| rt | | 0 to 9999 | 100°/hr | rP ≠ OFF |
| PL | | 0 to 100 | 100 | |
| dSP | | nor = Normal SEt = Set Point (lower display only) Pro = Process (upper display only) | nor | |

Operation Menu

Do not enter any values here; make photocopies instead.

| Parameters | Value | Range | Factory Default | Appears If: |
|------------|-------|---|---------------------------|------------------------------|
| Pb1 | | 0 to 999°F/0 to 555°C/0 to 999 Units 0 to 99.9°F/0 to 55.5°C/0 to 99.9 UNITS 0.0 to 999.9% of span 0 = ON/OFF control, HSC = Switching diff. | 25°F 2.5°F 3% / .3% | dFL = US dFL = SI |
| rE1 | | 0.00 to 9.99 repeats/minute / 0.00 = No reset | 0.00 repeats/minute | Pb1 ≠ 0 or dFL = US |
| It1 | | 00.0 to 99.9 minutes/repeat / 0.00 = No integral | 00.0 minutes/repeat | Pb1 ≠ 0 or dFL = SI |
| rA1 | | 0.00 to 9.99 minutes / 0.00 = No rate | 0.00 minutes | Pb1 ≠ 0 or dFL = US |
| dE1 | | 0.00 to 9.99 minutes / 0.00 = No derivative | 0.00 minutes | Pb1 ≠ 0 or dFL is SI |
| Ct1 | | 0.1 to 999.9 seconds | 5.0 seconds | Pb1 ≠ 0 or Output 1 ≠ 420 |
| Pb2 | | 1 to 999°F/0 to 555°C/0 to 999 Units 1 to 99.9°F/0 to 55.5°C/0 to 99.9 Units 0.1 to 999.9% of span | 25°F 2.5°F 3% / .3% | dFL = US |
| rE2 | | 0.00 to 9.99 repeats/minute / 0.00 = No reset | 0.00 repeats/minute | dFL = SI, Ot2 = Con, Pb1 ≠ 0 |
| It2 | | 00.0 to 99.9 minutes/repeat / 0.00 = No integral | 00.0 minutes/repeat | dFL = US, Ot2 = Con, Pb1 ≠ 0 |
| rA2 | | 0.00 to 9.99 minutes / 0.00 = No rate | 0.00 minutes | dFL = SI, Ot2 = Con, Pb1 ≠ 0 |
| dE2 | | 0.00 to 9.99 minutes / 0.00 = No derivative | 0.00 minutes | dFL = US, Ot2 = Con, Pb1 ≠ 0 |
| Ct2 | | 0.1 to 999.9 seconds | 5.0 seconds | Ot2 = Con, Pb1 ≠ 0 |
| ALO | | -999° to 0 | -999° | Ot2 = dE or dEA |
| AHI | | rL to AHI | rL | Ot2 = Pr or PrA |
| AHI | | 0 to 999° | 999° | Ot2 = dE or dEA |
| CAL | | ALO to rH | rH | Ot2 = Pr or PrA |
| CAL | | ± 180°F/±100°C/±180 Units | 0 | |
| AUt | | 0 = off, 1 = slow, 2 = medium, 3 = fast | 0 | |



| | |
|---------|-----------------------|
| LOC () | User lock out |
| In () | Input type |
| dEC () | Decimal place |
| C_F () | Celcius_Fahrenheit |
| rL () | Range low |
| rH () | Range high |
| Ot1 () | Output 1 |
| HSC () | Control hysteresis |
| Ot2 () | Output 2 |
| HSA () | Output 2 hysteresis |
| LA () | Latching for alarm |
| SIL () | Silence alarm |
| rtd () | RTD calibration curve |
| rP () | Ramp function |
| rt () | Ramp rate |
| PL () | Power limiting |
| dSP () | Display |
| 75 | |



| | |
|-------------|---------------------|
| 75 | Control Set Point |
| Pb1 () | Proportional band 1 |
| rE1/It1 () | Reset 1/Integral 1 |
| rA1/dE1 () | Rate 1/Derivative 1 |
| Ct1 () | Cycle time 1 |
| Pb2 () | Proportional band 2 |
| rE2/It2 () | Reset 1/Integral 1 |
| rA2/dE2 () | Rate 2/Derivative 2 |
| Ct2 () | Cycle time 2 |
| ALO () | Alarm low |
| AHI () | Alarm high |
| CAL () | Calibration offset |
| AUt () | Auto-tune |