



# SMART SERIES® Me

User Manual for Me6 & Me12

version 1



REMOVE AND RETAIN THIS SHEET

Every machine leaves our factory with two levels of password protection. We recommend that you remove this sheet in order to establish your own security.

User Password: unix  
System Password: linux

# Contents

<b>Section 1 - Introduction .....</b>	<b>1-1</b>
1.1 Intended Use.....	1-1
1.2 Release Details .....	1-1
1.3 Warranty Details.....	1-1
1.4 Returned Goods Policy.....	1-1
1.5 Movement or Resale of DME Products or Systems .....	1-1
1.6 Copyright.....	1-2
1.7 Units of Measure and Conversion Factors.....	1-2
<b>Section 2 - Global Support .....</b>	<b>1-3</b>
2.1 Corporate Offices.....	1-3
<b>Section 3 - Safety.....</b>	<b>3-1</b>
3.1 Introduction.....	3-1
3.2 Safety Hazards.....	3-2
3.3 Operational Hazards .....	3-5
3.4 General Safety Symbols.....	3-7
3.5 Wiring Check.....	3-8
3.6 Lockout Safety.....	3-9
3.7 Electrical Lockout .....	3-10
3.8 Energy Forms and Lockout Guidelines .....	3-11
3.9 Ground Connection .....	3-12
3.10 Disposal .....	3-12
3.11 Me Controller User Hazards.....	3-13
3.12 Operational Environment.....	3-13
<b>Section 4 - Overview .....</b>	<b>4-1</b>
4.1 Specification .....	4-1
4.2 The Controller Cabinet.....	4-2
4.3 Controller Modules .....	4-2
4.4 Thermocouple Inputs.....	4-2
4.5 Central Processor Units (CPUs) .....	4-2
4.6 Output Triacs.....	4-2
4.7 Power Supply .....	4-2
4.8 Screen Layout.....	4-3
4.9 Main Page .....	4-4
4.10 Monitoring .....	4-4
4.11 Main Page - Change Modes .....	4-5
4.12 More Pages.....	4-6
4.13 The User Interface.....	4-7
4.14 Screen Saver .....	4-7

## **Section 5 - Setup .....5-1**

5.1 Introduction.....	5-1
5.2 Default Settings .....	5-2
5.3 Configure the Controller.....	5-2
5.4 Set the Global Parameters .....	5-4
5.5 Zone Settings .....	5-6
5.6 Set the Temperature.....	5-8
5.7 Monitor Temperature Limits .....	5-10
5.8 Set Boost Temperature.....	5-12
5.9 Set Standby Value.....	5-14
5.10 Save a New Tool .....	5-16
5.11 Password Security .....	5-18
5.12 Password Options .....	5-18
5.13 Password Active Times.....	5-18
5.14 Set Password Control.....	5-19
5.15 Password Application Table.....	5-21

## **Section 6 - Operation .....6-1**

6.1 Isolate the Controller .....	6-1
6.2 Switch On.....	6-1
6.3 Switch Off (Shutdown).....	6-1
6.4 More about Run and Shutdown .....	6-2
6.5 Control Modes for All Zones .....	6-2
6.6 Boost Mode – Individual Zones .....	6-3
6.7 Switch Off Individual Zones.....	6-5
6.8 Return a Zone to Normal Operation .....	6-6
6.9 Set or Change Zone Temperatures.....	6-7
6.10 Change to Manual Mode .....	6-9
6.11 Slave Mode.....	6-11
6.12 Alarms .....	6-12
6.13 Mode Window.....	6-12
6.14 Status Window .....	6-13
6.15 Identify Zone Alarms.....	6-14
6.16 Alarm Extensions.....	6-14
6.17 The ToolStore Page .....	6-15
6.18 Choose a Tool .....	6-15
6.19 Load Tool Settings .....	6-16
6.20 Save the Tool Settings .....	6-17
6.21 Save the Changed Tool Settings.....	6-17
6.22 Delete a Tool .....	6-19
6.23 Backup Tool Settings .....	6-21
6.24 Restore Tool Settings.....	6-22
6.25 Restore a Tool .....	6-22

## **Section 7 - Maintenance.....7-1**

7.1 Self Diagnostic Tests .....	7-1
7.2 How the Test Works.....	7-1
7.3 Run a Self Diagnostic Test .....	7-2
7.4 Interpret the Test Results.....	7-4
7.5 Service and Repair The Controller .....	7-5
7.6 Replacement Parts .....	7-5
7.7 Cleaning and Inspection .....	7-5
7.8 Upgrade the Software.....	7-5
7.9 Preparation .....	7-5
7.10 Procedure .....	7-6
7.11 Fuses and Overcurrent Protection .....	7-6
7.12 Replacement Fuses.....	7-6
7.13 Supplementary Fuses.....	7-6
7.14 Controller Cards .....	7-7

## **Section 8 - Troubleshooting .....8-1**

8.1 Introduction.....	8-1
8.2 Other Possible Fault Conditions .....	8-4
8.3 Module Removal.....	8-4

## **Section 9 - Wiring of Hot Runner Controller .....9-1**

9.1 Three Phase Designation - Star / Delta Option .....	9-1
9.2 Set the Power Rail to the STAR Configuration .....	9-2
9.3 Set the Power Rail to the DELTA Configuration.....	9-4
9.4 Filter Option .....	9-6
9.5 Alarm Output / Auxiliary Input .....	9-6
9.6 USB Port.....	9-7
9.7 Standard Tool Connections .....	9-8

## **Index .....I**

## **Section 10 - Index .....I**

# Section 1 - Introduction

The purpose of this manual is to assist users in the integration, operation and maintenance of the Me controller. This manual is designed to cover most system configurations. If you need additional information specific to your system please contact your representative or a *DME* office whose location can be found in the “Global Support” section.

## 1.1 Intended Use

The Me Series controller together with the PTS console is an electrical distribution and control device designed as a multi channel temperature controller for use in hot runner plastic molding equipment. It uses feedback from thermocouples within the nozzles and manifolds to give precise closed-loop temperature control, and it is designed to be safe during normal operation. Any other uses would fall outside the engineered intent of this machine which may be a safety hazard and would void any and all warranties.

This manual is written for use by skilled persons who are familiar with injection molding machinery and their terminology. Operators should be familiar with plastic injection molding machines and the controls of such equipment. Maintenance persons should have sufficient understanding of electrical safety to appreciate the dangers of 3-phase supplies. They should know how to take appropriate measures to avoid any danger from electrical supplies.

## 1.2 Release Details

Table 1-1 Release Details		
Document Number	Release Date	Version
MeV2-UM-EN-00-01	January 2021	01

## 1.3 Warranty Details

For current warranty information please refer to the documents available from our website: <https://www.dme.net/terms-of-sale-returns/> or contact your *DME* representative.

## 1.4 Returned Goods Policy

Please do not return any parts to *DME* without pre-authorization and a return authorization number supplied by *DME*.

Our policy is one of continuous improvement and we reserve the right to alter product specifications at any time without giving notice.

## 1.5 Movement or Resale of DME Products or Systems

This documentation is intended for use in the country of destination for which the product or system was purchased.

*DME* takes no responsibility for documentation of products or systems if they are relocated or resold outside the intended country of destination, as stated on the accompanying invoice and/or waybill.

## 1.6 Copyright

© 2021 Mold-Masters (2007) Limited. All Rights Reserved. *Mold-Masters*® and the *Mold-Masters* logo are trademarks of Mold-Masters Limited.

## 1.7 Units of Measure and Conversion Factors



### NOTE

The dimensions given in this manual are from original manufacturing drawings.

All values in this manual are in S.I. units or subdivisions of these units. Imperial units are given in parenthesis immediately after the S.I. units.

Table 1-2 Units of Measure and Conversion Factors		
Abbreviation	Unit	Conversion Value
bar	Bar	14.5 psi
in.	Inch	25.4 mm
kg	Kilogram	2.205 lb
kPa	Kilopascal	0.145 psi
gal	Gallon	3.785 l
lb	Pound	0.4536 kg
lbf	Pound force	4.448 N
lbf.in.	Pound force inch	0.113 Nm
l	Litre	0.264 gallon
min	Minute	
mm	Millimeter	0.03937 in.
mΩ	Milli Ohm	
N	Newton	0.2248 lbf
Nm	Newton Meter	8.851 lbf.in.
psi	Pound per square inch	0.069 bar
psi	Pound per square inch	6.895 kPa
rpm	Revolutions per minute	
s	Second	
°	Degree	
°C	Degree Celsius	0.556 (°F -32)
°F	Degree Fahrenheit	1.8 °C +32

# Section 2 - Global Support

## 2.1 Corporate Offices

### GLOBAL HEADQUARTERS

**DME Company**  
29111 Stephenson Hwy.  
Madison Heights  
MI  
48071  
USA  
E: [dme@dme.net](mailto:dme@dme.net)  
P: +248.398.6000  
F: +248.544.5113  
TF: +800.626.6653  
(U.S. Only)

**DME of Canada**  
A – 99 First Gulf Blvd.  
Brampton  
ON  
L6W 4T8  
Canada

Unit 3  
5345 Outer Drive  
Oldcastle  
ON  
N9G 0C3  
Canada

E: [dme\\_canada@dme.net](mailto:dme_canada@dme.net)  
P: +905.677.6370  
F: +905.677.5280  
TF: +800.387.6600  
(Canada Only)

### DME de México

Circuito el Marqués Norte  
No. 55  
Parque Industrial El Marqués  
El Marqués  
Querétaro  
CP 76246  
Mexico  
E: [dme\\_mexico@dme.net](mailto:dme_mexico@dme.net)  
P: +442.713.5666

### DME of China

DME Mold Technology (Shenzhen) Co., Ltd.  
No 502, Building 5C  
Skyworth Innovation Valley Tangtou 1st RD  
Shiyan Subdistrict  
Baoan District Shenzhen  
Guangdong  
China  
E: [DMECN\\_CS@dme.net](mailto:DMECN_CS@dme.net)  
P: +86 (755) 8601 9031/9032  
F: +86 (755) 8601 6583  
TF: +800 830 9802

### DME EU

Czech Republic s.r.o.  
Smetanova 841  
CZ 755 01 Vsetín  
Czech Republic  
E: [dme\\_cz@dme.net](mailto:dme_cz@dme.net)  
P: +800 142 451 | +420 572 151 754  
F: +800 142 450 | +420 571 611 996



# Section 3 - Safety

## 3.1 Introduction

Please be aware that the safety information provided by *DME* does not absolve the integrator and employer from understanding and following international and local standards for safety of machinery. It is the responsibility of the end integrator to integrate the final system, provide necessary e-stop connections, safety interlocks and guarding, to choose the appropriate electrical cable for the region of use and to ensure compliance with all relevant standards.

It is the responsibility of the employer to:

- Properly train and instruct its personnel in the safe operation of equipment, including the use of all the safety devices.
- Provide its personnel with all necessary protective clothing, including such items as a face shield and heat resistant gloves.
- Ensure the original and continuing competence of personnel caring for, setting up, inspecting and maintaining injection molding equipment.
- Establish and follow a program of periodic and regular inspections of injection molding equipment to ensure it is in safe operating condition and proper adjustment.
- Ensure that no modifications, repairs or rebuild of portions are made to the equipment that reduces the level of safety existing at time of manufacture or remanufacture.

## 3.2 Safety Hazards



### WARNING

Also refer to all machine manuals and local regulations and codes for safety information.

The following safety hazards are most commonly associated with injection molding equipment. See European Standard EN201 or American Standard ANSI/SPI B151.1.

Refer to the illustration of hazard areas below when reading the Safety Hazards Figure 3-1 on page 3-2.

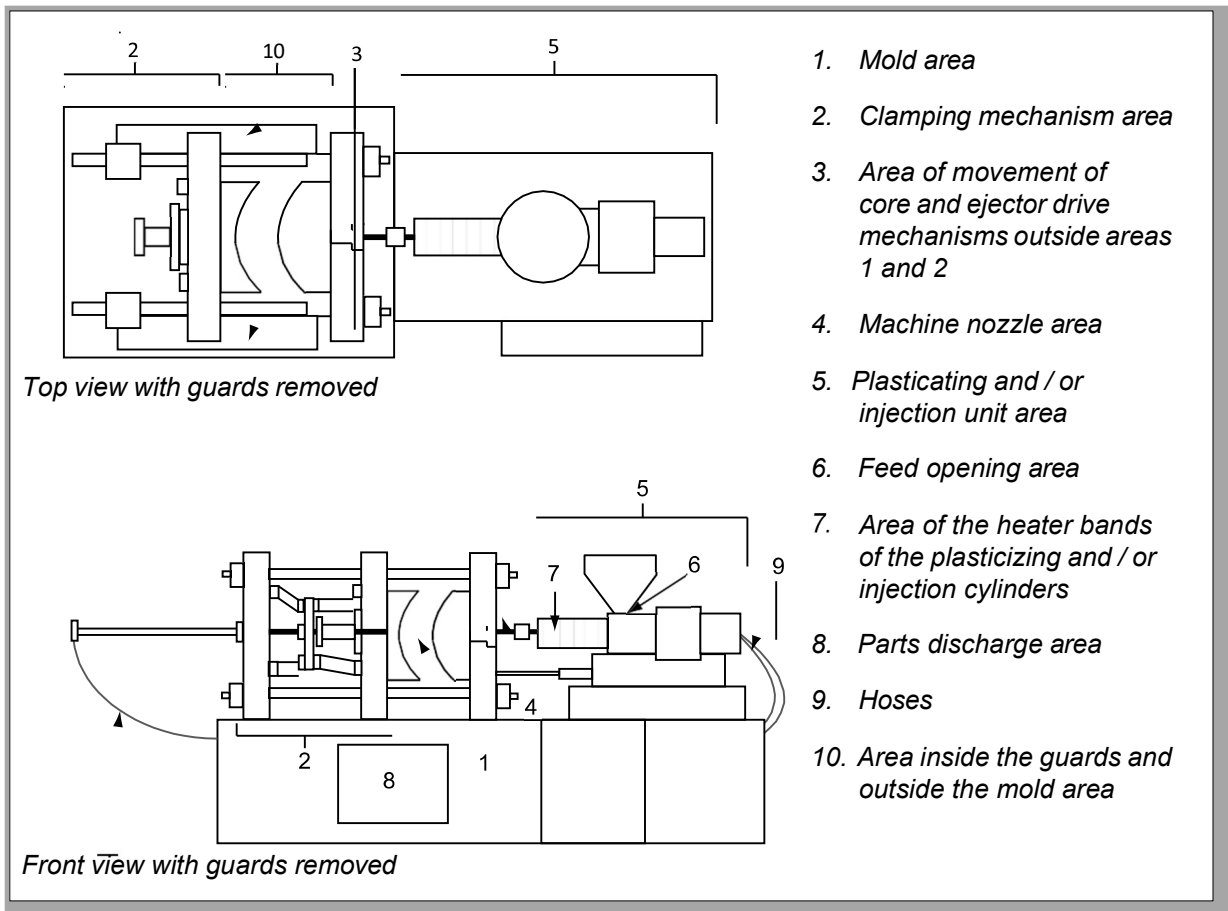

Figure 3-1 Hazard areas of an injection molding machine

<b>Table 3-1 Safety Hazards</b>	
<b>Hazard Area</b>	<b>Potential Hazards</b>
<p><b>Mold Area</b> Area between the platens. See Figure 3-1 area 1</p>	<p><b>Mechanical Hazards</b> Crushing and / or shearing and / or impact hazards caused by:</p> <ul style="list-style-type: none"> <li>• Movement of the platen.</li> <li>• Movements of the injection barrel(s) into the mold area.</li> <li>• Movements of cores and ejectors and their drive mechanisms.</li> <li>• Tie bar motion.</li> </ul> <p><b>Thermal Hazards</b> Burns and / or scalds due to operating temperature of:</p> <ul style="list-style-type: none"> <li>• The mold heating elements.</li> <li>• Material released from/through the mold.</li> </ul>
<p><b>Clamping Mechanism Area</b> See Figure 3-1 area 2</p>	<p><b>Mechanical Hazards</b> Crushing and / or shearing and / or impact hazards caused by:</p> <ul style="list-style-type: none"> <li>• Movement of the platen.</li> <li>• Movement of the drive mechanism of the platen.</li> <li>• Movement of the core and ejector drive mechanism.</li> </ul>
<p><b>Movement of Drive Mechanisms Outside the Mold Area and Outside the Clamping Mechanism Area</b> See Figure 3-1 area 3</p>	<p><b>Mechanical Hazards</b> Mechanical hazards of crushing, shearing and / or impact caused by the movements of:</p> <ul style="list-style-type: none"> <li>• Core and ejector drive mechanisms.</li> </ul>
<p><b>Nozzle Area</b> The nozzle area is the area between the barrel and the sprue bushing. See Figure 3-1 area 4</p>	<p><b>Mechanical Hazards</b> Crushing, shearing hazards and / or impact hazards caused by:</p> <ul style="list-style-type: none"> <li>• Forward movement of the plasticizing and / or injection unit including nozzle.</li> <li>• Movements of parts of the power-operated nozzle shutoff and their drives.</li> <li>• Over pressurization in the nozzle.</li> </ul> <p><b>Thermal Hazards</b> Burns and or scalds due to operating temperature of:</p> <ul style="list-style-type: none"> <li>• The nozzle.</li> <li>• Material discharging from the nozzle.</li> </ul>
<p><b>Plasticizing and / or Injection Unit Area</b> Area from the adapter / barrel head / end cap to the extruder motor above the sled including the carriage cylinders. See Figure 3-1 area 5</p>	<p><b>Mechanical Hazards</b> Crushing, shearing and / or drawn-into hazards caused by:</p> <ul style="list-style-type: none"> <li>• Unintentional gravity movements e.g. for machines with plasticizing and / or injection unit positioned above the mold area.</li> <li>• The movements of the screw and / or the injection plunger in the cylinder accessible through the feed opening.</li> <li>• Movement of the carriage unit.</li> </ul> <p><b>Thermal Hazards</b> Burns and / or scalds due to operating temperature of:</p> <ul style="list-style-type: none"> <li>• The plasticizing and / or injection unit.</li> <li>• The heating elements e.g. heater bands.</li> <li>• The material and / or vapors discharging from the vent opening, feed throat or hopper.</li> </ul> <p><b>Mechanical and / or Thermal Hazard</b></p> <ul style="list-style-type: none"> <li>• Hazards due to reduction in mechanical strength of the plasticizing and / or injection cylinder due to overheating.</li> </ul>
<p><b>Feed Opening</b> See Figure 3-1 area 6</p>	<p>Pinching and crushing between injection screw movement and housing.</p>

<b>Table 5-1 Safety Hazards</b>	
<b>Hazard Area</b>	<b>Potential Hazards</b>
<b>Area of the Heater Bands of the Plasticizing and / or Injection Cylinders</b> See Figure 3-1 area 7	Burns and / or scalds due to operating temperature of: <ul style="list-style-type: none"> <li>• The plasticizing and / or injection unit.</li> <li>• The heating elements e.g. heater bands.</li> <li>• The material and / or vapors discharging from the vent opening, feed throat or hopper.</li> </ul>
<b>Parts Discharge Area</b> See Figure 3-1 area 8	<b>Mechanical Hazards</b> Accessible Through the Discharge Area Crushing, shearing and / or impact hazards caused by: <ul style="list-style-type: none"> <li>• Closing movement of the platen</li> <li>• Movements of cores and ejectors and their drive mechanisms.</li> </ul> <b>Thermal Hazards</b> Accessible through the discharge area Burns and or scalds due to operating temperature of: <ul style="list-style-type: none"> <li>• The mold.</li> <li>• Heating elements of the mold.</li> <li>• Material released from / through the mold.</li> </ul>
<b>Hoses</b> See Figure 3-1 area 9	<ul style="list-style-type: none"> <li>• Whipping action caused by hose assembly failure.</li> <li>• Possible release of fluid under pressure that can cause injury.</li> <li>• Thermal hazards associated with hot fluid.</li> </ul>
<b>Area Inside the Guards and Outside the Mold Area</b> See Figure 3-1 area 10	Crushing and / or shearing and / or impact hazards caused by: <ul style="list-style-type: none"> <li>• Movement of the platen.</li> <li>• Movement of the drive mechanism of the platen.</li> <li>• Movement of the core and ejector drive mechanism.</li> <li>• Clamp opening movement.</li> </ul>
<b>Electrical Hazards</b>	<ul style="list-style-type: none"> <li>• Electrical or electromagnetic disturbance generated by the motor control unit.</li> <li>• Electrical or electromagnetic disturbance that can cause failures in the machine control systems and adjacent machine controls.</li> <li>• Electrical or electromagnetic disturbance generated by the motor control unit.</li> </ul>
<b>Hydraulic Accumulators</b>	High pressure discharge.
<b>Power Operated Gate</b>	Crush or impact hazards caused by the movement of the power operated gates.
<b>Vapors and Gases</b>	Certain processing conditions and / or resins can cause hazardous fumes or vapors.

### 3.3 Operational Hazards



#### WARNINGS

- Refer to all machine manuals and local regulations and codes for safety information.
- The equipment supplied is subjected to high injection pressures and high temperatures. Ensure that extreme caution is observed in the operation and maintenance of the injection molding machines.
- Only fully trained personnel should operate or maintain equipment.
- Do not operate the equipment with unconfined long hair, loose clothing or jewelry, including name badges, neckties, etc. These may get caught in the equipment and can cause death or serious injury.
- Never disable or bypass a safety device.
- Ensure that the protective guards are placed around the nozzle to prevent the material from splashing or drooling.
- A burn hazard exists from material during routine purging. Wear heat-resistant personal protective equipment (PPE) to prevent burns from contact with hot surfaces or splatter of hot material and gases.
- Material purged from machine may be extremely hot. Ensure protective guards are in place around the nozzle to prevent material from splashing. Use proper personal protective equipment.
- All operators should wear personal protective equipment, such as face shields and use heat resistant gloves when working around the feed inlet, purging the machine or cleaning the gates of the mold.
- Remove purged material from the machine immediately.
- Decomposing or burning material could result in noxious gases being emitted from the purged material, feed inlet or mold.
- Ensure proper ventilation and exhaust systems are in place to help prevent inhalation of harmful gases and vapors.
- Consult manufacturer's Material Safety Data Sheets (MSDS).
- Hoses fitted to the mold will contain high or low temperature fluids or air under high pressure. The operator must shut down and lockout these systems as well as relieving any pressure before performing any work with these hoses. Regularly inspect and replace all flexible hoses and restraints.
- Water and / or hydraulics on the mold may be in close proximity to electrical connections and equipment. Water leakage may cause an electrical short circuit. Hydraulic fluid leakage may cause a fire hazard. Always keep water and / or hydraulic hoses and fittings in good condition to avoid leaks.
- Never perform any work on the mold machine unless the hydraulic pump has been stopped.
- Check frequently for possible oil leaks / water leaks. Stop the machine and make repairs.

**WARNING**

- Make sure that the cables are connected to the correct motors. Cables and motors are clearly labeled. Reversing the cables can result in unexpected and uncontrolled motion causing a safety risk or damage to the machine. A crushing hazard exists between the nozzle and mold melt inlet during carriage forward motion.
- A possible shearing hazard exists between the edge of the injection guard and the injection housing during injection.
- The open feed port could present a hazard to a finger or a hand inserted during operation of the machine.
- The electric servo motors could overheat presenting a hot surface which could cause burns to someone touching it.
- The barrel, barrel head, nozzle, heater bands and mold components are hot surfaces which could result in burns.
- Keep flammable liquids or dust away from the hot surfaces as they could ignite.
- Follow good housekeeping procedures and keep floors clean to prevent slips, trips and falls due to spilled material on the work floor.
- Apply engineering controls or hearing conservation programs as necessary to control noise.
- When doing any work on the machine that requires moving and lifting the machine, ensure that lifting equipment (eyebolts, fork lift truck, cranes, etc.) will have sufficient capacity to handle mold, auxiliary injection unit or Hot Runner weight.
- Connect all lifting devices and support the machine using a crane of adequate capacity before commencing work. Failure to support the machine can result in severe injury or death.
- Mold cable from the controller to the mold must be removed before servicing the mold.

### 3.4 General Safety Symbols















Table 3-2 Typical Safety Symbols	
Symbol	General Description
	<b>General – Warning</b> Indicates an immediate or potentially hazardous situation, which if not avoided, could result in a serious injury or death, and / or damage to equipment.
	<b>Warning – Barrel Cover Grounding Strap</b> Lockout / tagout procedures must be followed before removing the barrel cover. Barrel cover can become energized upon removal of grounding straps and contact can result in death or serious injury. Grounding straps must be reconnected before reconnecting power to machine.
	<b>Warning – Crushing and / or Impact Points</b> Contact with moving parts can cause serious crushing injury. Always keep guards in place.
	<b>Warning – Crush Hazard Closing Mold</b>
	<b>Warning – Hazardous Voltage</b> Contact with hazardous voltages will cause death or serious injury. Turn off power and review electrical schematics before servicing equipment. May contain more than one live circuit. Test all circuits before handling to make sure circuits have been de-energized.
	<b>Warning – High Pressure</b> Overheated fluids may cause severe burns. Discharge pressure before disconnecting water lines.
	<b>Warning – High Pressure Accumulator</b> Sudden release of high pressure gas or oil can cause death or serious injury. Discharge all gas and hydraulic pressure before disconnecting or disassembling accumulator.
	<b>Warning – Hot Surfaces</b> Contact with exposed hot surfaces will cause serious burn injury. Wear protective gloves when working near these areas.
	<b>Mandatory – Lockout / Tagout</b> Ensure that all energies are properly locked out, and remain locked out until the service work is completed. Servicing equipment without disabling all internal and external power sources can cause death or serious injury. De-energize all internal and external power sources (electrical, hydraulic, pneumatic, kinetic, potential, and thermal).
	<b>Warning – Molten Material Splashing Hazard</b> Molten material or high pressure gas can cause death or severe burns. Wear personal protective equipment while servicing the feed throat, nozzle, mold areas and when purging the injection unit.
	<b>Warning – Read Manual Before Operation</b> Personnel should read and understand all instructions in the manuals before working on equipment. Only properly trained personnel should operate the equipment.
	<b>Warning – Slip, Trip or Fall Hazard</b> Do not climb on equipment surfaces. Serious slip, trip, or fall injuries can result from personnel climbing on equipment surfaces.

Table 3-2 Typical Safety Symbols	
Symbol	General Description
	<b>Caution</b> Failure to follow instructions may damage equipment.
	<b>Important</b> Indicates additional information or used as a reminder.

### 3.5 Wiring Check



#### CAUTION

##### System Mains Supply Wiring:

- Before connecting the system to a power supply, it is important to check that the wiring between the system and the power supply has been done correctly.
- Particular attention must be given to the current rating of the power supply. For example, if a controller is rated at 63A, then the power supply must also be rated at 63A.
- Check that the phases of power supply are wired correctly.

##### Controller to Mold Wiring:

- For separate power and thermocouple connections, ensure that the power cables are never connected to the thermocouple connectors and vice-versa.
- For mixed power and thermocouple connections, ensure that the power and thermocouple connections have not been wired incorrectly.

##### Communications Interface and Control Sequence:

- It is the customer's responsibility to verify functionality of any custom machine interface at safe speeds, prior to operating equipment in the production environment at full speed in automatic mode.
- It is the customer's responsibility to verify all required motion sequences are correct, prior to operating equipment in the production environment at full speed in automatic mode.
- Switching the machinery into Auto mode without having verified the control interlocks and motion sequence are correct, may cause damage to machinery and / or equipment.

Failure to do wiring or connections properly will result in equipment failure.

The use of *DME* standard connections can help to eliminate the potential for wiring errors.

*DME Company* cannot be responsible for damage caused by customer wiring and / or connection errors.



## 3.6 Lockout Safety



### WARNING

DO NOT enter the cabinet without first isolating the supplies.

High voltage and amperage cables are connected to the controller and the mold. Electrical power must be shut off and lockout / tagout procedures followed prior to installing or removing any cables.

Use lockout / tagout to prevent operation during maintenance.

All maintenance should be performed by properly trained personnel based on local laws and regulation. Electrical products may not be grounded when removed from the assembled or normal operating condition.

Ensure proper grounding of all electrical components before performing any maintenance to avoid potential risk of electrical shock.

Often power sources are inadvertently turned on or valves are opened mistakenly before maintenance work is completed, resulting in serious injuries and fatalities. Therefore, it is important to ensure that all energies are properly locked out and that they remain locked out until the work is completed.

If a lockout is not performed, uncontrolled energies could cause:

- Electrocution from contact with live circuits
- Cuts, bruises, crushing, amputations or death, resulting from entanglement with belts, chains, conveyors, rollers, shafts, impellers
- Burns from contact with hot parts, materials or equipment such as furnaces
- Fires and explosions
- Chemical exposures from gases or liquids released from pipelines



### 3.7 Electrical Lockout

#### **WARNING - READ MANUAL**

Refer to all machine manuals and local regulations and codes.

#### **NOTE**

In some instances, there may be more than one power source feeding equipment and steps must be taken to ensure that all sources are effectively locked out.

Employers must provide an effective lockout / tagout program.

1. Shut down machine using normal operational shutdown procedure and controls. This should be done by, or in consultation with the machine operator.
2. After ensuring that the machinery has been completely shut down, and all controls in the “off” position, open the main disconnect switch located in the field.
3. Using your own personal padlock, or one assigned by your supervisor, lock the disconnect switch in the off position. Do not lock only the box. Remove the key and retain. Complete a lockout tag and affix to the disconnect switch. Each person working on the equipment must follow this step. The lock of the person doing the work or in charge must be installed first, remain throughout and be removed last. Test the main disconnect switch and make sure it cannot be moved to the “on” position.
4. Try to start the machine using the normal operation controls and point of operation switches to make sure that the power has been disconnected.
5. Other sources of energy that could create a hazard while working on the equipment must also be de-energized and appropriately “locked-out”. This can include gravity, compressed air, hydraulics, steam and other pressurized or hazardous liquids and gases. See Table 3-3.
6. When the work is completed, prior to removing the last lock, make sure the operational controls are in the “off” position so that the main disconnect switching is done under “no load”. Ensure all blocks, tools and other foreign materials are removed from machine. Also ensure that all personnel that may be affected are informed that the lock(s) will be removed.
7. Remove lock and tag, and close the main disconnect switch if permission has been given.
8. When the work has not been completed on the first shift, the next operator should install a personal lock and tag before the first operator removes the original lock and tag. If the next operator is delayed, a lock and tag could be installed by the next supervisor. Lockout procedures should indicate how the transfer is to be conducted.
9. It is important that, for their personal protection, each worker and/or foreperson working in or on a machine places his/her own safety lock on the disconnect switch. Use tags to spotlight work in progress and give details of work being done. Only when the work is completed and the work permit signed off, may each worker remove his/her lock. The last lock to be removed should be that of the person supervising the lockout and this responsibility should not be delegated.

© Industrial Accident Prevention Association, 2008.

### 3.8 Energy Forms and Lockout Guidelines

Table 3-3 Energy Forms, Energy Sources and General Lockout Guidelines		
Energy Form	Energy Source	Lockout Guidelines
<b>Electrical Energy</b>	<ul style="list-style-type: none"> <li>• Power transmission lines</li> <li>• Machine power cords</li> <li>• Motors</li> <li>• Solenoids</li> <li>• Capacitors (stored electrical energy)</li> </ul>	<ul style="list-style-type: none"> <li>• Turn off power at machine first (i.e., at point of operation switch), and then at the main disconnect switch for the machine.</li> <li>• Lock and tag the main disconnect switch.</li> <li>• Fully discharge all capacitive systems (e.g., cycle machine to drain power from capacitors) according to the manufacturer's instructions.</li> </ul>
<b>Hydraulic Energy</b>	<ul style="list-style-type: none"> <li>• Hydraulic systems (e.g., hydraulic presses, rams, cylinders, hammers)</li> </ul>	<ul style="list-style-type: none"> <li>• Shut off, lock (with chains, built-in lockout devices, or lockout attachments) and tag valves.</li> <li>• Bleed off and blank lines as necessary.</li> </ul>
<b>Pneumatic Energy</b>	<ul style="list-style-type: none"> <li>• Pneumatic systems (e.g., lines, pressure reservoirs, accumulators, air surge tanks, rams, cylinders)</li> </ul>	<ul style="list-style-type: none"> <li>• Shut off, lock (with chains, built-in lockout devices, or lockout attachments) and tag valves.</li> <li>• Bleed off excess air.</li> <li>• If pressure cannot be relieved, block any possible movement of machinery.</li> </ul>
<b>Kinetic Energy (Energy of a moving object or materials. Moving object may be powered or coasting)</b>	<ul style="list-style-type: none"> <li>• Blades</li> <li>• Flywheels</li> <li>• Materials in supply lines</li> </ul>	<ul style="list-style-type: none"> <li>• Stop and block machine parts (e.g. stop flywheels and ensure that they do not recycle).</li> <li>• Review entire cycle of mechanical motion, ensure that all motions are stopped.</li> <li>• Block material from moving into area of work.</li> <li>• Blank as necessary.</li> </ul>
<b>Potential Energy (Stored energy that an object has the potential to release due to its position)</b>	<ul style="list-style-type: none"> <li>• Springs (e.g., in air brake cylinders)</li> <li>• Actuators</li> <li>• Counterweights</li> <li>• Raised loads</li> <li>• Top or movable part of a press or lifting device</li> </ul>	<ul style="list-style-type: none"> <li>• If possible, lower all suspended parts and loads to the lowest (rest) position.</li> <li>• Block parts that might be moved by gravity.</li> <li>• Release or block spring energy.</li> </ul>
<b>Thermal Energy</b>	<ul style="list-style-type: none"> <li>• Supply lines</li> <li>• Storage tanks and vessels</li> </ul>	<ul style="list-style-type: none"> <li>• Shut off, lock (with chains, built-in lockout devices, or lockout attachments) and tag valves.</li> <li>• Bleed off excess liquids or gases.</li> <li>• Blank lines as necessary.</li> </ul>

### 3.9 Ground Connection

The ground connection is in the following location on the Me controller:

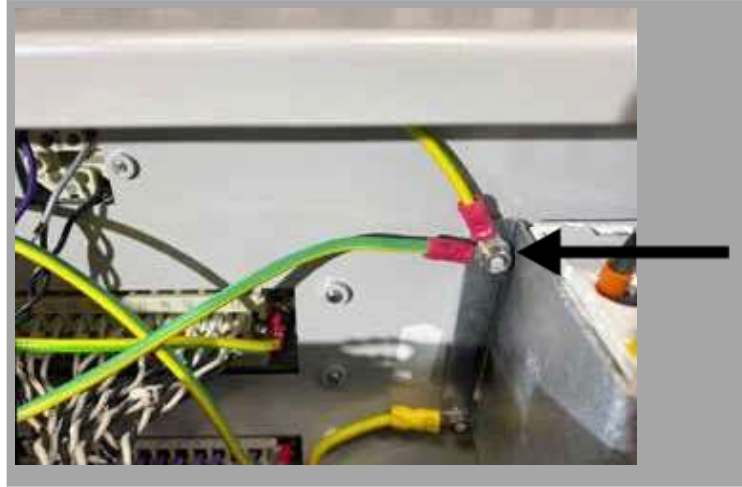

Figure 3-2 Ground connection of the Me controller

### 3.10 Disposal



#### **WARNING**

DME declines any responsibility for personal injury or personal damage arising from reuse of the individual components, if these parts are used other than for the original and proper intended purpose.

1. Hot runner and system components must be disconnected from the power supply fully and properly before disposal, including electricity, hydraulics, pneumatics and cooling.
2. Ensure that the system to be disposed of is free from fluids. In the case of hydraulic needle valve systems, drain the oil from the lines and cylinders and dispose it in an environmentally responsible manner.
3. The electrical components are to be dismantled, separating them accordingly as environmentally-friendly waste or disposed as hazardous waste if necessary.
4. Remove the wiring. The electronic components are to be disposed in accordance with the national electric scrap ordinance.
5. The metal parts are to be returned for metal recycling (waste metal and scrap trade). The instructions of the corresponding waste disposal company are to be observed in this case.

Recycling of all recyclable materials should be a priority of the disposal process.

### 3.11 Me Controller User Hazards



#### **WARNING - ELECTRIC SHOCK HAZARD**

It is crucial to comply with these warnings to minimize any personal danger.

- Ensure that all energies are properly locked out in the controller and mold machine before installation of the controller into the system.
- DO NOT enter the cabinet without first ISOLATING the supplies. There are unguarded terminals inside the cabinet which may have a dangerous potential across them. Where a three-phase supply is used, this potential may be up to 415 VAC.
- Voltage and amperage cables are connected to the controller and the mold. Electric power must be shut off and lockout / tagout procedures followed prior to installing or removing any cables.
- Integration should be done by properly trained personnel based on local codes and regulations. Electrical products may not be grounded when removed from the assembled or normal operating condition.
- Do not mix electrical power cables with thermocouple extension cables. They are not designed to carry the power load or list accurate temperature readings in each other's application.
- The main power switch is on the lower left of the rear of the controller. It is sufficiently rated to disconnect the total load current during switch on and switch off.
- The main power switch can be locked using a padlock applied under the lockout / tagout procedure found in "3.6 Lockout Safety" on page 3-9.
- Use lockout / tagout to prevent operation during maintenance.
- All maintenance should be performed by properly trained personnel based on local codes and regulation. Electrical products may not be grounded when removed from the assembled or normal operating condition.
- Ensure proper grounding of all electrical components before performing any maintenance to avoid potential risk of electrical shock.

### 3.12 Operational Environment



#### **WARNING**

The display console and controller cabinet together are designed for use in the plastic injection moulding industry as temperature controllers for third party hot runner systems as commonly used in mold tools. They must not be used in residential, commercial or light-industrial environments. Furthermore, they must not be used in an explosive atmosphere, or where there is a possibility of such an atmosphere developing.

The controller cabinet and touchscreen console should be installed in a clean dry environment where the ambient conditions do not exceed the following limits:

- Temperature                    +5 to +45°C
- Relative Humidity            90% (non-condensing)

# Section 4 - Overview



## WARNING

Ensure that you have fully read "Section 3 - Safety" before connecting or operating the controller.

## 4.1 Specification

The following are general specifications. The actual controller / console supplied may have contractual variations and differ in some specified options.

Table 4-1 General Specifications	
<b>Alarm Output</b>	Closing Contact Relay 5 Amp max
<b>Control Range</b>	0 - 472° Celsius (Centigrade), 32-842° Fahrenheit
<b>Heater Tool Connector</b>	Harting type Han E or equivalent
<b>Mains Voltage Output Pattern</b>	Burst-fired or zero voltage crossover
<b>Output Overload Protection</b>	High-speed semiconductor fuse links
<b>Overload Protection</b>	Miniature Circuit Breaker
<b>Tool Transfer Connector</b>	USB port
<b>Relative Humidity Limit</b>	90% (non-condensing)
<b>Supply Earth-Leakage Trip</b>	300mA <b>Note:</b> this is for tool protection
<b>Supply Voltage</b>	415 Volts 3-phase 50/60 Hz with neutral. Other available include 240/380/400 and 600 volts in Star or Delta configuration
<b>T/C Tool Connector</b>	Harting type Han A or equivalent
<b>Temperature Control Method</b>	Closed loop (Auto) or open loop (Manual) with HR software
<b>Temperature Scale</b>	Celsius (Centigrade) or Fahrenheit
<b>Voltage Bandwidth</b>	Stable within (20% supply voltage swing)

## 4.2 The Controller Cabinet

The power supply to the control cabinet is via a strain-relief mounted cable and plug, and it may be wired in Star or Delta configuration. Please check your specifications for details on which style has been configured. There are normally two types of cables supplied: a thermocouple connection and a power connection, both using type HAN24E as a preferred connector.

Refer to "Section 9 - Wiring of Hot Runner Controller" for more information.

An alarm output option is available for extending the alarm or inhibiting the injection process.

## 4.3 Controller Modules

The controller uses six-zone modules that provide real time temperature control.

Each card has three main components:

- thermocouple input CPU
- two control CPUs
- multi-voltage output triacs

## 4.4 Thermocouple Inputs

The thermocouple inputs have preset responses for both J and K- type thermocouples. The associated console provides means of selecting the sensor type which, in turn, sets the CPU linearization to match the selected thermocouple type.

## 4.5 Central Processor Units (CPUs)

The CPU provides the following facilities:

- closed and open loop control of the zones
- processes thermocouple and current readings to show on display
- checks for alarm conditions, including excess current, incorrect thermocouple wiring, zone over temperature condition, low impedance between heater and ground, and generates alarm information for the display screen and alarm relay
- controls the output power to the on-board triac using a number of self-tuning algorithms

The card requires no analogue calibration and is ready for use once set up from the display console.

## 4.6 Output Triacs

The controller card has six on-board triacs, one for each channel that are capable of controlling heating loads of up to 15 Amps peak.

## 4.7 Power Supply

The DC power supplies for the cards, data communications and an alarm output relay are all provided by a single power supply unit. This is located on top of the upper chassis panel.

## OVERVIEW

## 4.8 Screen Layout

### Monitoring

The main page has up to 12 zones displayed at maximum size.

Probe 1	Probe 2	Probe 3	Probe 4	
250	250	250	250	Run
250 °C	250 °C	250 °C	250 °C	Standby
1.0 A	1.1 A	1.2 A	1.3 A	Shutdn
Probe 5	Probe 6	Probe 7	Probe 8	
249	249	249	249	Boost
250 °C	250 °C	250 °C	250 °C	Stop
1.4 A	1.5 A	1.6 A	1.7 A	
Probe 9	Probe 10	Probe 11	Probe 12	
248	250	250	250	Tool
250 °C	250 °C	250 °C	250 °C	
1.8 A	1.9 A	2.0 A	2.1 A	
Mode: RUN				Status: NORMAL

### Control

The side command buttons change from page to page.

Probe 1	Probe 2	Probe 3	Probe 4	
250	250	249	249	Run
250 °C	250 °C	250 °C	250 °C	Standby
1.0 A	1.1 A	1.2 A	1.3 A	Shutdn
Probe 5	Probe 6	Probe 7	Probe 8	
249	249	249	249	Boost
250 °C	250 °C	250 °C	250 °C	Stop
1.4 A	1.5 A	1.6 A	1.7 A	
Probe 9	Probe 10	Probe 11	Probe 12	
250	250	250	250	Tool
250 °C	250 °C	250 °C	250 °C	
1.8 A	1.9 A	2.0 A	2.1 A	
Mode: RUN				Status: NORMAL

### Information

The bottom row shows

- on the left: the Mode window
- on the right: the Status window

Probe 1	Probe 2	Probe 3	Probe 4	
250	250	249	249	Run
250 °C	250 °C	250 °C	250 °C	Standby
1.0 A	1.1 A	1.2 A	1.3 A	Shutdn
Probe 5	Probe 6	Probe 7	Probe 8	
249	249	249	249	Boost
250 °C	250 °C	250 °C	250 °C	Stop
1.4 A	1.5 A	1.6 A	1.7 A	
Probe 9	Probe 10	Probe 11	Probe 12	
250	250	250	250	Tool
250 °C	250 °C	250 °C	250 °C	
1.8 A	1.9 A	2.0 A	2.1 A	
Mode: RUN				Status: NORMAL





### 4.9 Main Page

Can be used for:

- **Monitor** – observe zone condition
- **Control** – Start / Stop / Boost / Standby / Shutdown. All modes are available from the **[Mode]** button.
- **Set** – choose any one or more zones to get **[Set]** function to set or alter zone setpoints.

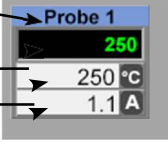
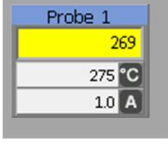
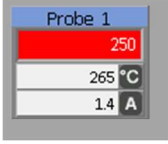
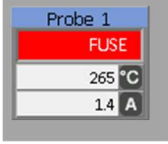
### 4.10 Monitoring

<p><b>Healthy Zone</b> which shows</p> <p>Zone Name (Alias) _____</p> <p>Actual Temperature _____</p> <p>Scale + Set Temperature _____</p> <p>Applied Current _____</p>		<p>Actual temperature is green text on black background.</p>
<p><b>Warning Zone</b></p> <p>Deviation exceeds 1st stage (Warning).</p>		<p>Actual temperature is black text on a yellow background.</p>
<p><b>Alarm Zone</b></p> <p>Deviation exceeds 2nd stage (Alarm).</p>		<p>Actual temperature is white text on red background.</p>
<p><b>Fatal Error</b></p> <p>Problem detected.</p> <p>See Table 8-1 for a list of possible error messages.</p>		<p>Error message reads as white text on red background.</p>
<p><b>Zone Off</b></p> <p>Individual zone switched off.</p>		

OVERVIEW

### 4.11 Main Page - Change Modes

The main page shows all available modes.



Confirmation is required to choose a new mode.



### 4.12 More Pages

#### The ToolStore Page

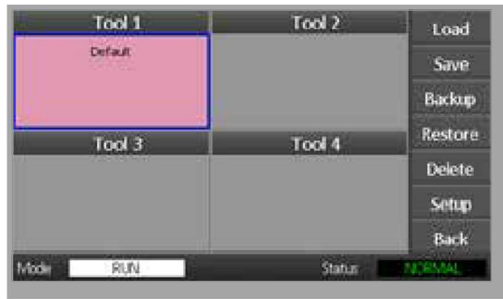

#### The Setup Tool Page

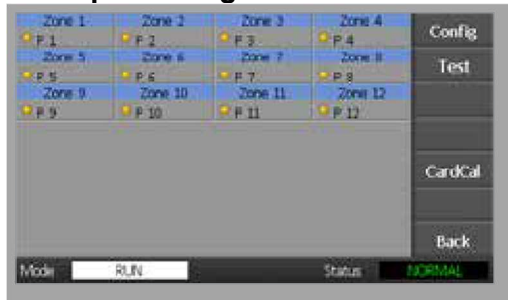

#### The Graph Page

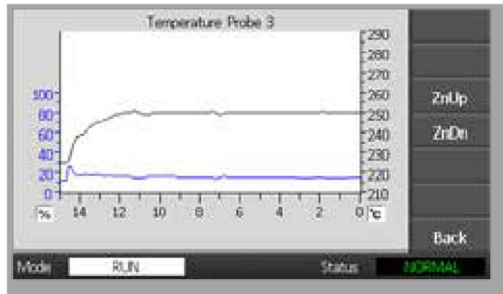

#### The Zoom Page



## 4.13 The User Interface

Where the configuration of parameters requires a user interface then either a keyboard or a keypad is displayed.

**Keyboard** - for alphanumeric input



**Keypad 1** – for basic numeric input



**Keypad 2** - is an extended keypad which adds:

- **Value Keys** – Set, Add and Subtract, to set temperature
- **Mode Keys** – Auto, Manual and Boost, to set working mode

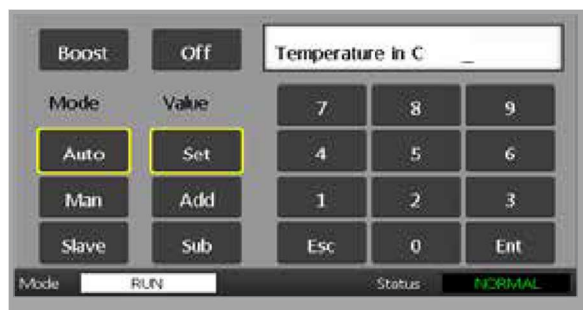

## 4.14 Screen Saver

The screen backlight turns off after five minutes of inactivity.

Touch the screen to reactivate it.

# Section 5 - Setup

## 5.1 Introduction



### WARNING

Ensure that you have fully read "Section 3 - Safety" before connecting or operating the controller.

It is the responsibility of the integrator to understand and follow international and local standards for safety of machinery when integrating the controller with the molding system.

The Me controller should be located in such a way that the main disconnect is easily accessible in case of emergency.

Me controllers are shipped with a power cable which is a correct size to run the system. When you install a connector on the cable, ensure that the connector can safely withstand the full system load.

The Me controller supply should have a fused disconnect or main circuit breaker according to local safety codes. Refer to the serial plate on the controller cabinet for confirmation of the supply requirements. If the local supply is outside the specified range, please contact *DME* for advice.



### WARNING - ELECTRICAL SHOCK HAZARD

It is crucial to comply with these warnings to minimize any personal danger.

- Ensure that all energies are properly locked out in the controller and molding machine before installation of the controller into the system.
- There are unguarded terminals inside the cabinet which may have a dangerous potential across them. Where a three-phase supply is used, this potential may be up to 415 VAC.
- Integration should be done by properly trained personnel based on local law or regulation requirements. Electrical products may not be grounded when removed from the assembled or normal operating condition.
- Voltage and amperage cables are connected to the controller and the mold. Electric power must be shut off and lockout / tagout procedures followed prior to installing or removing any cables.
- Do not mix electrical power cables with thermocouple extension cables. They are not designed to carry the power load or list accurate temperature readings in each other's application.



### WARNING - TRIP HAZARD

The integrator should ensure that the controller cables do not present a trip hazard on the floor between the controller and the mold machine.



### IMPORTANT

We recommend that you run a self diagnostic routine (See Section 7.3) to check that all zones are correctly sequenced and that there is no crosswiring between zones or between heater outputs and thermocouple inputs.

## 5.2 Default Settings

Me controllers leave the factory with their default settings as shown below:

Table 5-1 Default Controller Settings	
Boost Level	0°C or 0°F
Over / Under Temperature Range	10°C or 18°F
Maximum Power	85%
Standby Level	65°C or 118°F
Zone Temperature	0°C or 0°F

## 5.3 Configure the Controller

The following options apply universally for every tool.



### NOTE

The tool settings may be different for different tools. For example, Tool 1 may display temperatures in °C and Tool 2 may display temperatures in °F.

1. Choose **[Tool]** to open the ToolStore page.



2. Choose **[Setup]** to open the Setup Tool page. If prompted, enter the System password.

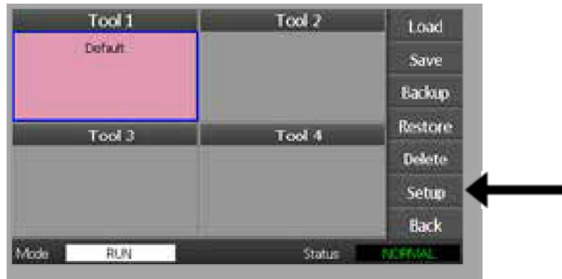

3. Choose **[Config]** to display the configuration options.

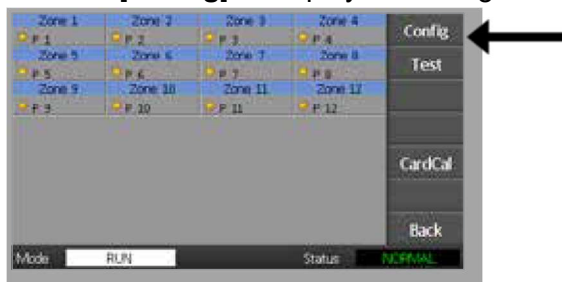

4. Choose [**Options**] to open the Controller Settings pages.

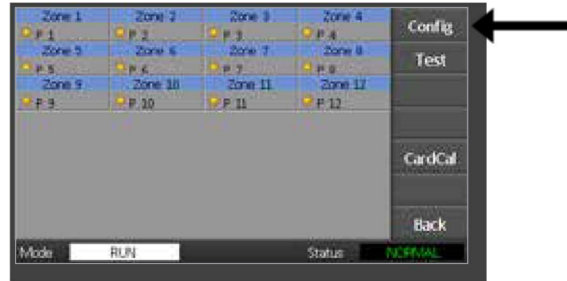

Settings on these pages include:

- (a) [**Input**] – the single channel input (HAN4A socket) can be configured to start in Boost or Standby mode.
- (b) [**Power Display**] – choose the zone panel information to show percentage power or actual current.
- (c) [**Amps Display**] – choose to display the actual peak current or the average current.
- (d) [**Language**] – choose the preferred user language.
- (e) [**Scale**] – temperatures may be set to show as either Celsius or Fahrenheit.
- (f) [**Password Control**] – allows you to disable passwords so that all operations may be available for open control.
- (g) [**Earth Leakage**] – allows you to disable the display of Earth Leakage current and switch on or off the earth leakage control on the card.
- (h) [**Force if Slow**] – allows you to force to Fast zones that are in Auto and detected as Slow.



5. Choose an option.  
The option button will turn blue.
6. Choose [**Enter**] to confirm the selection or [**Back**] to leave the page without making any changes.

### 5.4 Set the Global Parameters

Setting of the global parameters applies to all tools of the controller.

1. Choose **[Tool]** to open the ToolStore page.



2. Choose **[Setup]** to open the Setup Tool page. If prompted, enter the System password.



3. Choose **[Config]** to display the configuration options.





4. Choose [**Global**] to open the Global Settings panel.



Settings within this panel include:



- **Boost Time** - to enter the time for which the temperature will increase whenever the Boost mode is selected.



**NOTE**

The maximum Boost Time that is permitted is 500 seconds.

- **Maximum Temperature** – to limit the highest temperature to which any zone may be raised.



**NOTE**

The Maximum Temperature that is permitted is 450° C or 842°F.

- **Maximum Power** – to limit the highest power to which any zone may be raised.



**NOTE**

The Maximum Power level that is permitted is 100%.

Choose [**Edit**] to set any parameter or [**Back**] to close the panel and leave without making any changes.

### 5.5 Zone Settings

When setting up a new tool, the following options can be set on a zone by zone basis for any tool.

1. Choose **[Tool]** to open the ToolStore page.



2. Choose **[Setup]** to open the Setup Tool page. If prompted, enter the System password.

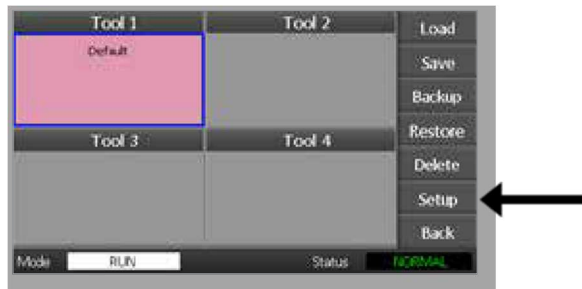

3. Choose one or more zones to see new command buttons. Choose **[Set]** to view the next page.



4. Choose [**Options**] to open the Zone Settings pages.

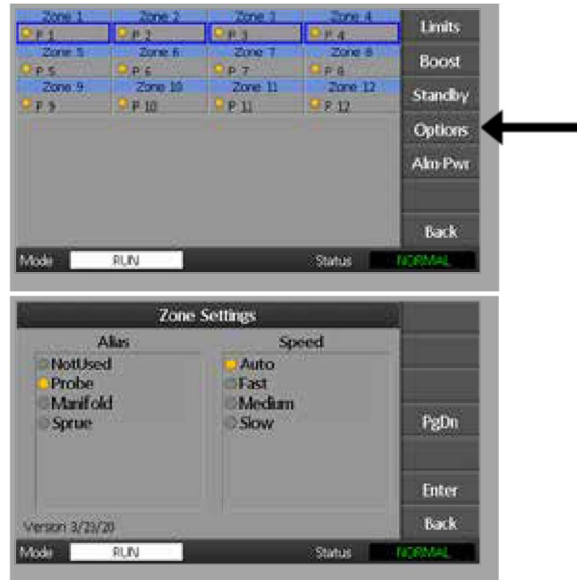

Settings on these pages include:

- **Alias** – uses the selected a title to identify a group of zones as either Probes, Manifolds or Sprues. “Not Used” allows you to switch off spare zones so they do not show on the main page.
  - **Speed** – zones can be set to Auto-detect, Fast, Medium, or Slow.
  - **Sensor** – allows you to match the controller to either a J-type or K-type thermocouple.
5. Choose an option.  
The option button will turn blue.
  6. Choose [**Enter**] to confirm the selection or [**Back**] to leave the page without making any changes.

### 5.6 Set the Temperature

1. Choose the first zone.



2. Choose the last zone.



3. Choose [Range].



4. Choose [Set].



If prompted, enter the User password.



5. Use the keypad to enter a new temperature. Choose **[Ent]** to set the required temperature or **[Bsp]** to leave the page without making any changes.

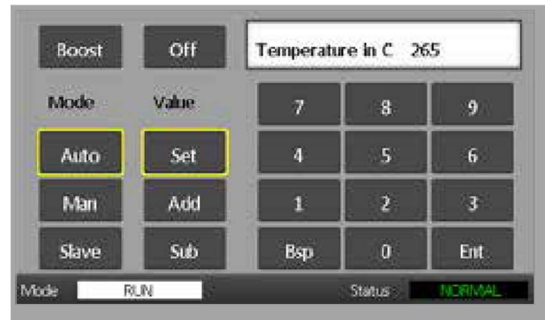

The new set temperatures are now displayed on the Main page:



**NOTE**

The zones may individually show an alarm if the new set temperature is significantly different from the actual temperature. The system sees this as a temporary condition and will not show an overall alarm condition until the tool has had time to reach the new set temperatures.

## 5.7 Monitor Temperature Limits

The controller card monitors the actual temperature of each zone and verifies that the zone is operating within specific limits. Rather than fixed points of temperature, the High and Low limits are set as deviation above or below the set point. If any zone temperature goes outside these limits, a visual alarm is shown which is extended to an alarm relay for external switching.

### Warning and Alarm Limits

Although there is only one upper and one lower alarm setting, each gives a visual warning at a halfway point. If a High alarm is set to 10 degrees then a Warning will show at 5 degrees. The same is applicable for the under temp alarm level.

1. Choose **[Tool]** to open the ToolStore page.



2. Choose **[Setup]** to open the Setup Tool page. If prompted, enter the System password.



3. Choose one or more zones, using one of the following methods.
  - Choose one zone at a time until you have selected all the required zones.
  - Choose the first zone, the last zone, and **[Range]** to include all the zones in between.

- Choose **[Set]** to show the zone setting options.



- Choose **[Limits]** to open the Alarm Limits panel.



- Choose either High or Low **[Edit]** from the Alarm Limits panel to reveal a keypad.
- Enter the amount by which the temperature must rise or fall to trigger an alarm.



**NOTE**

Temperature limits are applicable to the current scale. A High limit of “10” in Celsius automatically becomes “18” if the scale is changed to Fahrenheit.

- Choose **[Back]** to return to Main page.

### 5.8 Set Boost Temperature

The Boost temperature may be individually set for each zone as described in the table below.

When Boost is activated, the controller will raise the zone temperature.



**NOTE**

On a slow responding manifold, if you set a high Boost temperature, the zone may not reach the set Boost temperature before the Boost time limit expires.

The Boost period is user-configurable. To set the Boost period, see section "5.4 Set the Global Parameters".

1. Choose **[Tool]** to open the ToolStore page.



2. Choose **[Setup]** to open the Setup Tool page. If prompted, enter the System password.

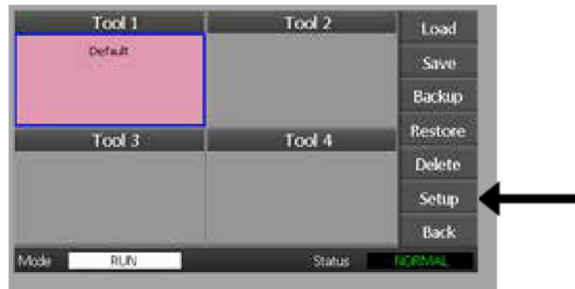

3. Choose one or more zones, using one of the following methods.
  - Choose one zone at a time until you have selected all the required zones.
  - Choose the first zone, the last zone, and **[Range]** to include all the zones in between.



- Choose [Set] to show the zone setting options.



- Choose [Boost].



- Choose [Edit] from the Boost panel.
- Enter the required Boost temperature.



**NOTE**

The maximum permitted Boost temperature is 100° C or 180° F.



- Choose [Back] to return to the Main page.

### 5.9 Set Standby Value

The Standby amount must be configured before this feature can be used. The Standby settings made here are only for Standby temperature and are individually set for each zone. When Standby is activated, those zones with any Standby value configured will reduce their temperature.

1. Choose **[Tool]** to open the ToolStore page.



2. Choose **[Setup]** to open the Setup Tool page. If prompted, enter the System password.

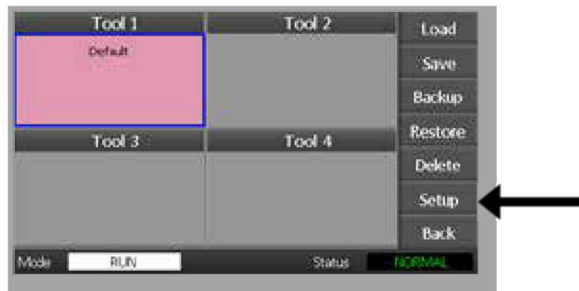

3. Choose one or more zones, using one of the following methods.
  - Choose one zone at a time until you have selected all the required zones.
  - Choose the first zone, the last zone, and **[Range]** to include all the zones in between. Choose **[Set]** to show the Zone setting options

4. Choose **[Standby]** to open the Standby panel.



5. Choose **[Edit]** from the Standby panel to show the keypad.

6. Enter the required Standby temperature.

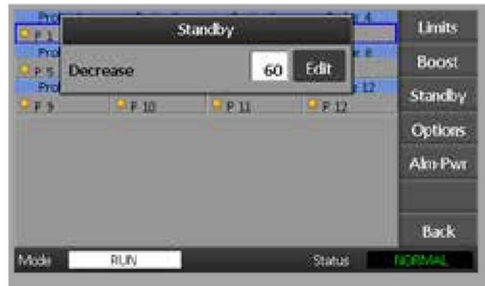
**NOTE**

The maximum permitted Standby temperature is 100° C or 180° F.

7. Choose **[Back]** to return to the Main page.

### 5.10 Save a New Tool

1. Choose [Tool] to open the ToolStore Page.



2. Choose any blank tool slot then choose [New].

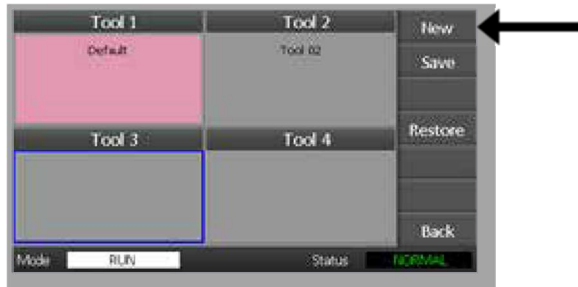

3. Enter the Tool Name and choose the [Enter] button.



**NOTE**

The maximum length allowed for a tool name is 12 characters.



4. Choose [Load] and [OK] to accept the new tool.

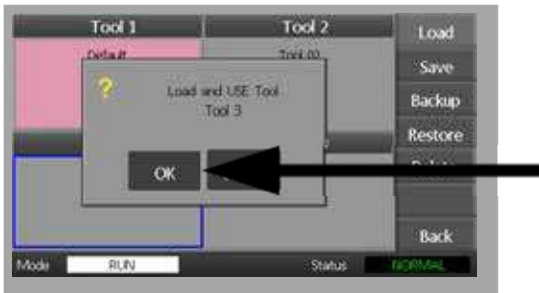

- Return to the ToolStore page to see the new tool with the new name.

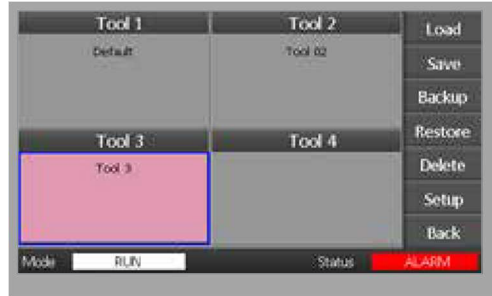

- Choose **[Back]** to return to the Main page with the new tool saved.



## 5.11 Password Security

Every machine leaves our factory with two levels of password protection, and these passwords are provided on a detachable page at the front of the manual.

Some functions of the touchscreen controller are protected by password access. If a password is required, the keyboard will be displayed.

## 5.12 Password Options

### 5.12.1 Password Enabled

If the user password option is set to [**Enabled**] then there are three levels of control:

1. Open Level - includes various functions that need no password, such as Run and Stop
2. User is a Level-1 password that gives low level access to
  - (a) switch tools
  - (b) change temperatures
  - (c) create, save, and backup new tools
3. System is a Level 2 password which gives high level access to
  - (a) all user level functions
  - (b) reconfigure the settings for a new tool
  - (c) restore and delete tools

### 5.12.2 Password Disabled

If the password option is set to [**Disabled**], then all functions that would normally need a User / Level 1 password become Open level and they no longer require any password to access.

## 5.13 Password Active Times

After you key in a password, access is possible while you continue to input data. Each keytouch resets the timer. After 20 seconds of inactivity, the screen will time out.



#### **NOTE**

This is the same for both User / Level 1 and System / Level 2 passwords.

If the system user password is active but the user visits a page requiring a Level 1 password or no password, then the System password will expire after 20 seconds. The user will still be able to access any page that requires a Level 1 password or no password.

### 5.14 Set Password Control

1. Choose [Tool].



2. Choose [Setup].

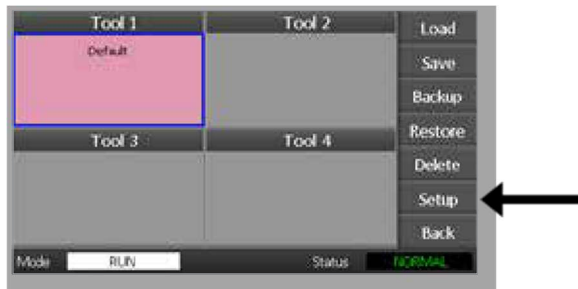

If prompted, enter a password.



**NOTE**

Either the User or System password can be used.



3. Choose [**Config**].



4. Choose [**Options**].



5. Choose [**PgDn**] three times to go to Password Control.



6. Choose [**Enable**] to have a higher level password control or [**Disable**] for Open control.
7. Choose [**Enter**] to accept the setting or [**Back**] to return to the Main page.



### 5.15 Password Application Table

Use Table 5-2 as a quick reference for password level requirements:

<b>Table 5-2 Password Application Table</b>			
<b>Page / Screen</b>	<b>No Password is required to</b>	<b>Level 1 (User) Password is required to:</b>	<b>Level 2 (System) password is required to:</b>
<b>Main</b>	Run / Stop / Change Modes Change display options Go to Zoom or Graph page	Set (Alter temperatures or modes)	
<b>Zoom</b>	View only No other function except zone up or down		
<b>Graph</b>	View only No other function except zone up or down		
<b>Tools</b>	View available tools	Load Save Backup New (Create new tools)	Restore Delete
<b>Tools - Setup</b>			Set Config (Change any values)

# Section 6 - Operation



## WARNING

Ensure that you have fully read "Section 3 - Safety" before operating the controller.

The Operation section of the manual describes how use the controller. This includes stopping and starting the controller, how to adjust temperatures and settings and how to recognize alarms.

## 6.1 Isolate the Controller

The main power switch is sufficiently rated to disconnect the total load current during switch on and switch off. To prevent its operation during maintenance, you can use a suitably-sized padlock or similar device to lock the switch in the off position.

## 6.2 Switch On

When the controller is switched on, all zones go into Stop mode.

## 6.3 Switch Off (Shutdown)



## NOTE

DME recommends that you use the console to shut down the heating load.

1. On the Main page, choose **[Stop]** to shut down the heating load.



2. Pull down the breaker switch to shut down the controller.



## 6.4 More about Run and Shutdown

**RUN** – the system measures the heat gain of every zone and automatically holds back the faster (probe) zones to the same rise rate as the slowest rising zone. This ensures that you get a homogenous rise across the whole tool.

**SHUTDOWN** – the system operates in a similar but reverse method to startup. It switches off the slowest zone and sets the set temperature of all others to be 30° lower. This ensures that you get a smooth uniform cool down across the whole tool.

## 6.5 Control Modes for All Zones



### WARNING

Choosing Stop mode does not remove voltage from the heaters.

**Do not try to change fuses or disconnect units while in this mode.**

1. Choose a control mode.



2. Choose [OK] to confirm the change to the new mode.



Table 6-1 Control Modes for All Zones

Operation	Available By	Description
<b>BOOST</b>	Mode Button	Temporarily raises the temperature of all zones that have any Boost temperature configured. When the Boost period expires, zone temperatures return to their normal set levels.
<b>RUN</b>	Mode Button	System is started in a homogenous heat rise, in which all zones follow the slowest rising zone. It will switch to RUN when working temperature has been reached.
<b>SHUTDOWN</b>	Mode Button	System is shutdown in a homogenous heat reduction. It will switch to STOP when temperatures are less than 90°C.
<b>STANDBY</b>	Mode Button	Reduces temperatures of all zones that have Standby Temperatures configured. Temperature remains reduced until RUN command is given.
<b>STOP</b>	Mode Button	Set all power levels to zero. Tool cools down to room temperature at its own rate.

## 6.6 Boost Mode – Individual Zones

This mode provides a means of temporarily boosting the zone temperature for any one or more zones for a preset (user-configurable) period.

1. Choose any one or more zones.



2. Choose [Set].



3. Enter a password.



**NOTE**

Either the User or System password can be used.

The keypad is displayed:



4. Choose [**Boost**] and set the required Boost temperature.



The screen returns to the Main page and the boosted temperature is shown:



The zone returns to normal temperature after the preset Boost time.

### 6.7 Switch Off Individual Zones

1. Choose any one or more zones.



2. Choose [Set].



3. Enter a password.



**NOTE**  
Either the User or System password can be used.

The keypad is shown:



## OPERATION

- Choose **[Off]** to switch off the selected zones.



- Return to the Main page to check that the selected zone is switched off.



## 6.8 Return a Zone to Normal Operation

- Choose the zone.
- Choose **[Set]**.



- On the keypad, choose **[On]**.

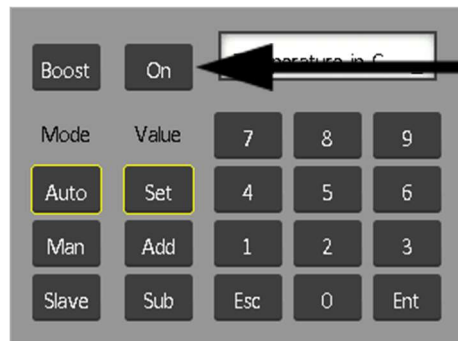

## 6.9 Set or Change Zone Temperatures

1. Choose the first zone.



2. Choose the last zone.



3. Choose [Set].



### NOTE

Temperature and power settings have preset limits as described in section "5.4 Set the Global Parameters".

4. Enter the password.



## OPERATION

- To set a new temperature, choose **[Set]** and enter a value.  
To raise the overall temperature, choose **[Add]** and enter a value to raise the current temperature by.  
To lower the overall temperature, choose **[Sub]** and enter a value to lower the current temperature by.

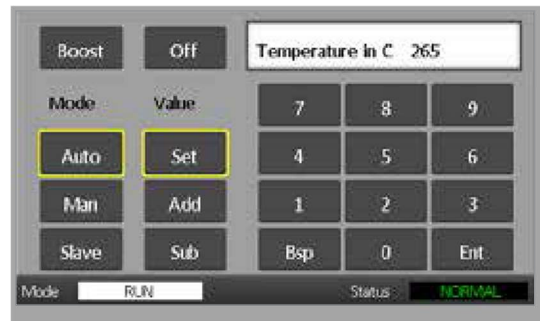

The new set temperatures are shown on the Main page:

Probe 1	Probe 2	Probe 3	Probe 4	
250	250	250	250	Run
260 °C	260 °C	260 °C	260 °C	Standby
1.0 A	1.1 A	1.2 A	1.3 A	Shutdown
Probe 5	Probe 6	Probe 7	Probe 8	
250	250	250	250	Boost
265 °C	265 °C	265 °C	265 °C	Stop
1.4 A	1.5 A	1.6 A	1.7 A	Tool
Probe 9	Probe 10	Probe 11	Probe 12	
250	250	250	250	
250 °C	250 °C	250 °C	250 °C	
1.8 A	1.9 A	2.0 A	2.1 A	

Mode: RUN Status: NORMAL

**NOTE**

The zones may individually show an alarm if the new set temperature is significantly different from the actual temperature. The system interprets this as a temporary condition and will not show an overall alarm condition until the tool has had time to attain the new set temperatures.

## 6.10 Change to Manual Mode

Manual mode (open loop working) can be selected as an alternative to running in Auto mode (closed loop working).

1. Choose the first zone



2. Choose the last zone.



3. Choose [Set].



4. Enter a password.



### NOTE

Either the User or System password can be used.

- Choose **[Man]** and enter the percentage.  
Choose **[Ent]**.



**NOTE**

Temperature and power settings have preset limits as described on page 5-5.



## 6.11 Slave Mode

Slave mode is an alternative to Manual mode and can be selected if one zone has a faulty thermocouple. The slaved zone mimics the same power output as the healthy zone, and, provided that they had been running at a similar power level previously, the slaved zone will maintain a similar temperature.

1. Choose any zone to display the Command buttons.



2. Choose [Set].



3. Enter a password.



**NOTE**

Either the User or System password can be used.

4. Choose [Slave].  
Enter the number of a healthy zone.  
Choose [Ent].



5. Return to the Main page to check that the first zone is now slaved to the second selected zone.  
The slaved zone will display the number of the zone to which it has been slaved:



## 6.12 Alarms

The Mode and Status windows are found at the bottom of every page.



If the controller is switched on and running normally, the Mode window will show RUN and the Status window will show NORMAL.

## 6.13 Mode Window

The Mode window at the bottom left corner of the display shows the current mode for the controller. The mode flashes.

Table 6-2 lists the different mode window displays:

Mode	Display	Description
RUN	Black text on white	All control zones are working normally.
STOP	White text on blue	The System has been shut down and the heaters are below 90°C / 194°F.
STANDBY	Yellow text on black	Any zones with Standby temperatures configured have been reduced in temperature until the next command is given.
STARTUP		The system has been started in a homogenous heat rise. It will switch to RUN when working temperature has been reached.
SHUTDOWN		The system has been shut down in a homogenous heat fall. It will switch to STOP when 90°C / 194°F has been reached.
BOOST	Black text on yellow	Any zones with Boost temperatures configured are being temporarily raised.

## 6.14 Status Window

The right Status window shows NORMAL if all the zones are at their set temperature and no faults have been detected. If any zone detects a fault then the Status window changes its display and color as detailed below:

Display	Color	Description
<b>NORMAL</b>	Green text on black	Controller is running normally.
<b>WARNING</b>	Black text on yellow	A zone's temperature exceeds the warning limits.
<b>ALARM</b>	White text on red	This shows either a fatal error or that a zone's temperature exceeds alarm limits.





### NOTE

The Status Alarm is only active when in RUN mode in order to prevent slower systems from raising unnecessary alarms.

Once at their set temperature, systems switch to RUN mode and the alarm becomes active.

## 6.15 Identify Zone Alarms

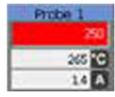
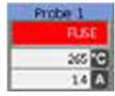
Zone	Display	Description
<b>Normal Zone</b> This shows a healthy zone.		The Actual Temperature is green text on black background.
<b>Warning Zone</b> This shows a first stage warning.		The Actual Temperature is black text on yellow background.
<b>Alarm Zone</b> This shows a second stage alarm.		The Actual Temperature is white text on red background.
<b>Fatal Error</b> An abbreviated error message. For a list of error messages see Table 8-1.		The error message is white text on red background.

## 6.16 Alarm Extensions

There is a ring of LEDs in the Alarm light in the upper left of the front of the console that act as an alarm repeater. They light up whenever the console generates an alarm.

This may not mimic the Status window. Individual zones may show alarms if the new set temperatures are significantly different to the existing temperatures. The system will not show an overall alarm condition until the tool has had time to reach the new set temperatures.

## 6.17 The ToolStore Page

The initial page shows the 4 tool slots that can be used to save different settings for different tools.

The tool that is currently loaded and being used is highlighted in pink:

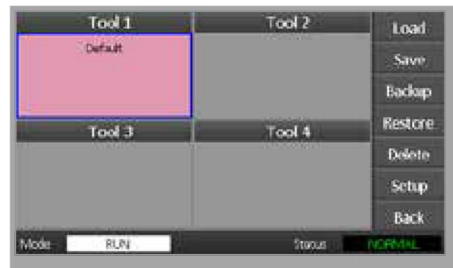

Other tool slots that have saved tool settings can be identified by the names within their boxes.

## 6.18 Choose a Tool

1. Choose a tool slot.  
The border of the box turns to blue to indicate that it has been chosen.
2. Choose **[Load]**.  
Choose **[OK]** to confirm use of this tool.
3. Choose **[Back]** to return to the previous page.
4. Choose **[Setup]**.  
Enter the System password.

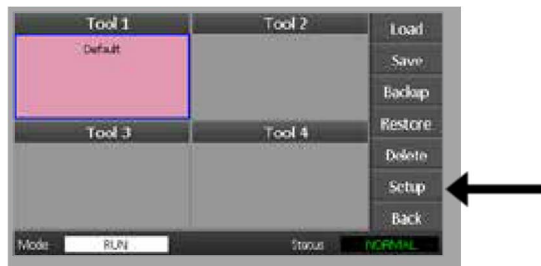

The Tool Setup page offers more control of the setup of the tool. See "Section 5 - Setup".





## 6.19 Load Tool Settings



### NOTE

If the controller is in RUN mode and another tool setting with a different temperature is selected and loaded, then the tool will immediately change to run at the new incoming temperature setting.

1. Choose a tool.



2. Choose [Load].
3. Enter the System password.
4. Choose [OK] to load the tool.



## 6.20 Save the Tool Settings

Changes made to the currently loaded tool will be saved shortly after your last screen touch.

## 6.21 Save the Changed Tool Settings

If you need to use different tools for different applications, you must create new tools to hold the different settings.

1. Choose a blank tool slot.



2. Choose [**Save**].



3. Enter the System password.
4. Enter a new tool name.



5. Choose [**Ent**].

6. Return to the ToolStore page to see the new tool with the new name.
7. Choose the tool.

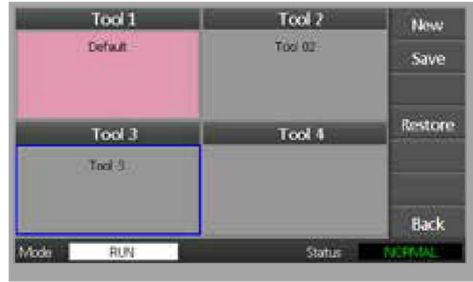

8. Choose **[Load]**.
9. Choose **[OK]** to confirm.

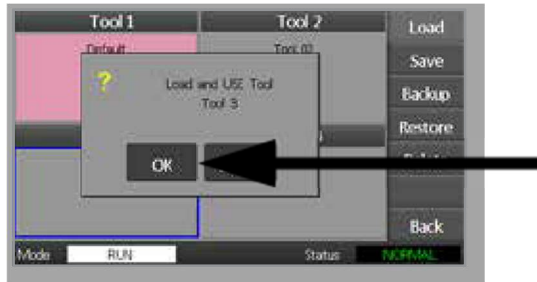

10. Leave this page, and make all necessary changes.

This process creates a new tool with new settings.

To restore the original tool settings, return to the ToolStore page and choose the original tool.

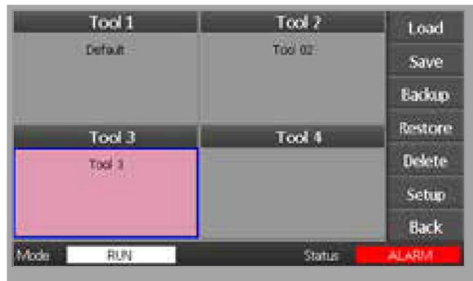

## 6.22 Delete a Tool



### CAUTION

Once you have deleted a tool there is no way to recover its previous settings. Ensure that you are deleting the correct tool.

1. Choose the tool to be deleted.

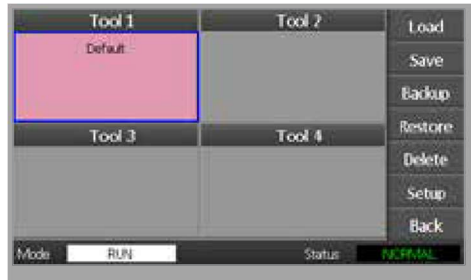

2. Choose **[Delete]**.

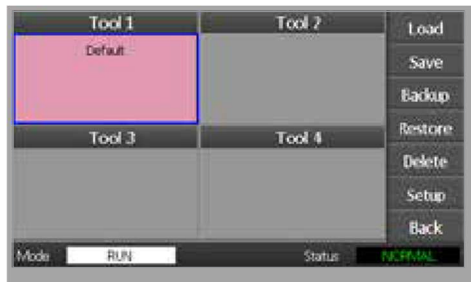

### NOTE

If you try to delete the current tool, a warning panel appears telling you that you cannot delete the current tool.

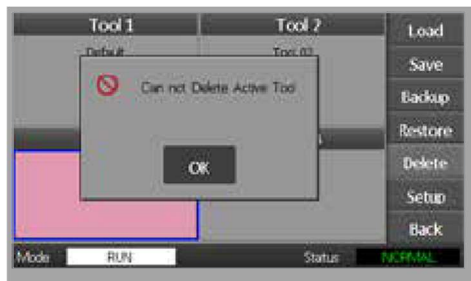

3. Press **[OK]** to return to the ToolStore page.
4. Choose the tool to be deleted.
5. Choose **[Delete]**.  
A prompt appears asking the user to confirm the action.

6. Choose **[OK]** to confirm.

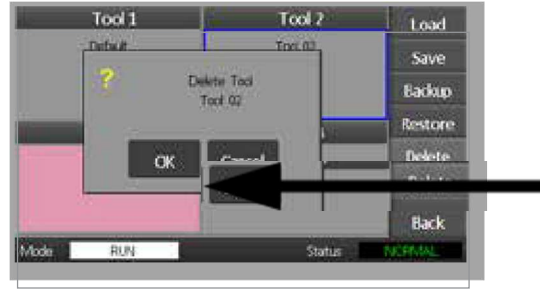

7. Return to the ToolStore page to check that the unwanted tool has been deleted.

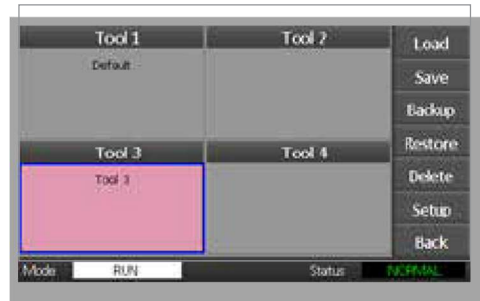

## 6.23 Backup Tool Settings

Backing up tools is a means of saving tool settings to an external storage device. The saved settings can be used for secure recovery or can be transferred to another controller for use.

1. Insert the memory stick.

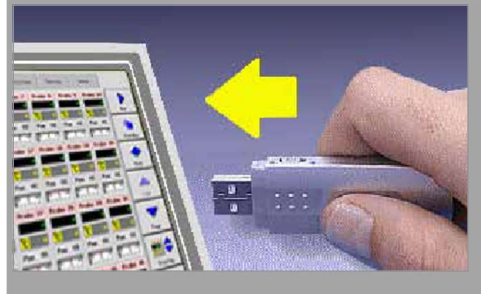

2. Choose the tool to backup.

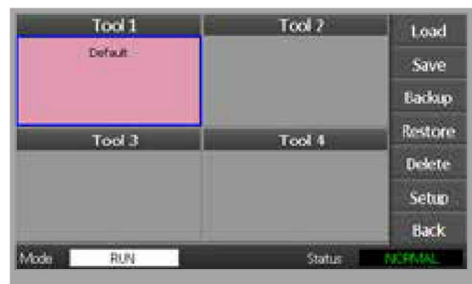

3. Choose **[Backup]**.

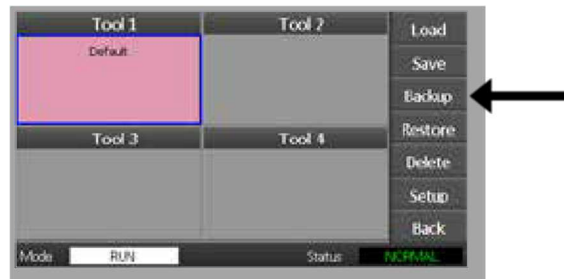

### NOTE

If there is a problem saving to the memory stick, a warning message is displayed. Repeat the procedure using a different memory stick.

4. Remove the memory stick.



## 6.24 Restore Tool Settings



### IMPORTANT

Any information stored in the selected tool slot will be overwritten with the information from the memory stick.

## 6.25 Restore a Tool

1. Insert the memory stick.

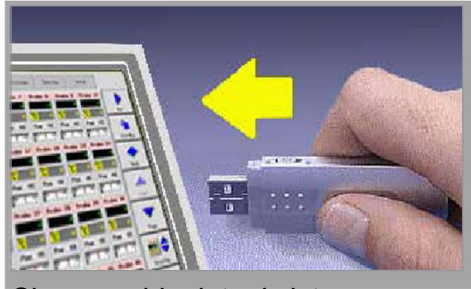

2. Choose a blank tool slot.

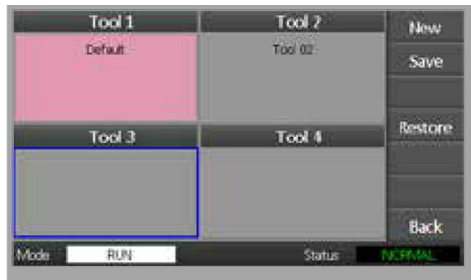

3. Choose **[Restore]**.

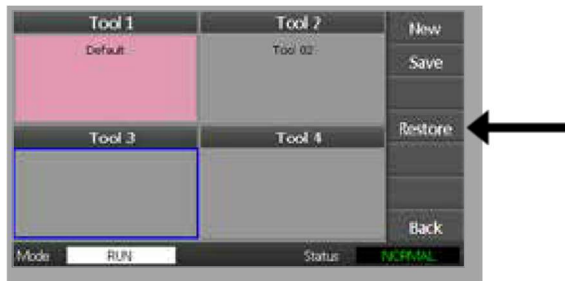

4. Remove the memory stick.

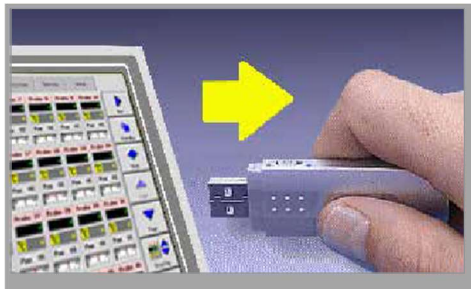

# Section 7 - Maintenance



## WARNING

Ensure that you have fully read "Section 3 - Safety" before doing maintenance procedures on the controller.

Maintaining the controller includes checking records and settings, and running self-diagnostic tests.

There are no user serviceable parts inside the touchscreen controller. In the unlikely event of equipment failure, return the unit for repair.

## 7.1 Self Diagnostic Tests

The controller has a diagnostic testing tool, which allows you to check that every zone is functioning correctly.

It is the correct routine that you should use:

- as an acceptance check
- to see that a new tool is wired up correctly
- as a maintenance aid, to check that a working tool is functioning correctly

## 7.2 How the Test Works

The following describes the test sequence to show how it works.

It applies 10% power and observes that:

- (a) the temperature of the zone under test does not reduce further – which would indicate a reversed thermocouple on that zone
- (b) the zone under test rises sufficiently to a set level – if not it increases the applied power and looks again for that temperature rise. It continues to raise the power and look for the expected temperature until a set timer expires. If it does not see the right temperature within the right time, then the zone has failed
- (c) no other zone rises by as much as the first set temperature, which would indicate cross-wiring between the zone under test and another thermocouple
- (d) no other zone rises significantly which would indicate excessive thermal conduction between adjacent zones

After completing the test on the first zone, the routine then moves on to subsequent zones until all have been tested.

At the end of the test it builds a list of results to show how the test progressed.



### 7.3 Run a Self Diagnostic Test

The diagnostic routine may be performed at any time that the controller is connected to the tool, if it is not in use for production.

1. Choose **[Tool]**.



2. Choose **[Setup]**.  
If prompted, enter the System password.

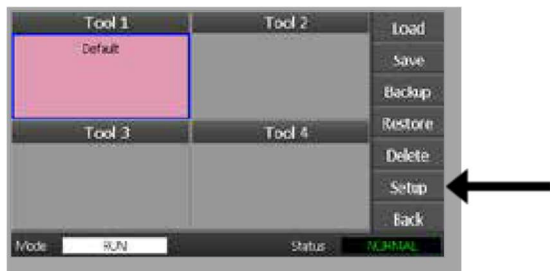

3. Choose **[Test]**.



4. Choose **[OK]** to start the test.



## MAINTENANCE

The Mode window then shows “Testing” and the first zone temperature display will read “Test”.

- (a) Choose [**Stop**] at any time to end the test prematurely.
- (b) Choose [**Skip**] at any time to skip a zone and move on to the next.
- (c) If you choose [**Back**] the test will finish and no test results will be displayed.



At the end of the test sequence the controller will build a test result page to show how the test progressed for each zone.

Any zone that fails a test is highlighted by a red button marker followed by a brief explanation or a code to show why it failed.



5. At the end of the test, choose [**Save**] to export the results to an external memory stick as a CSV file.
6. Choose [**Back**] to leave the test page and return to the ToolStore page.

## 7.4 Interpret the Test Results

### 7.4.1 Satisfactory Test

If the diagnostic test finds no fault with any zone then the message “Zone Test OK” is displayed against every zone.

### 7.4.2 Unsatisfactory Test

If the test detects any problems then it displays an error message against the particular zone. See Table 7-1 for a full list of error messages.

Table 7-1 System Diagnosis Error Messages	
Error Message	Description
<b>Below 0 or Reversed T/C</b>	May be caused by a reversed thermocouple. <b>Note:</b> if the test was carried out at an ambient temperature below 0°C, the controller would not work with the resulting negative temperature readings.
<b>FUSE</b>	Check card fuse.
<b>REV</b>	Temperature appeared to be decreasing when power was applied.
<b>Failed to React Correctly</b>	Unexpected results. This message is followed by further error messages.
<b>Heater / T/C Common with Zone NN?</b>	Crosswiring fault between displayed zones. Could be either heater or thermocouple wiring at fault.
<b>Heating Test Failed</b>	Temperature did not rise by the set number of degrees within the heating period. This may be caused by an open circuit heater, a pinched, shorted or dislodged thermocouple.
<b>No Mains Sync. Pulse</b>	Likely due to an error in the supply wiring.
<b>N/Z</b>	No card was detected in the unit at the slot identified with the displayed zone.
<b>T/C</b>	Thermocouple detected as being open circuit. Check thermocouple wiring for displayed zone.
<b>T/C Interaction with Zone NN?</b>	Different zone(s) to the one being tested had an unacceptable rise in temperature, greater than Bad Rise set in test values. Indicates faulty T/C positioning or close zone proximity.
<b>User Stopped</b>	The test was stopped.
<b>User Skipped</b>	The test for this zone was skipped while it was being tested.

## 7.5 Service and Repair The Controller



### WARNING - HIGH VOLTAGE

Always isolate the controller at source before you open the unit to inspect it or replace fuses.



### CAUTION

External cables should be checked to see that there has been no damage to the flexible conduit, plugs or sockets. If the flexible conduit has been damaged or if there are any exposed conductors, it must be replaced.

Any internal cable forms that flex to accommodate opening doors should be checked to see that there is no fraying or damage to cable insulation.



### CAUTION

Only use ceramic body fuses on control cards. Never use glass-bodied fuses.

## 7.6 Replacement Parts

DME does not expect that you will need to repair any controller parts at board level other than fuses. In the unlikely event of any board failure, we provide an excellent repair and exchange facility for all our customers.

## 7.7 Cleaning and Inspection

Any excess dust that has entered into the cabinet may be removed with a light brush and vacuum cleaner.

If the equipment is subject to vibration then we recommend that you use an insulated screwdriver to check that no terminals have become loose.

## 7.8 Upgrade the Software

In order to maintain our high quality, our development engineers are making continual improvements to our control system.

It may be possible to apply system upgrades to your own controller depending on the type and age of your equipment. Please contact your supplier and provide the serial number for your model to find out if your particular console can be upgraded.

There is usually no need to return your control system to your supplier for any upgrades. They may be downloaded via the internet.

## 7.9 Preparation

1. Download the upgrade from the internet onto a personal computer.
2. Copy the upgrade program / data onto memory stick.



### IMPORTANT

Before you start any upgrade, shutdown your machine to leave your console free.

### 7.10 Procedure

1. Release the controller from production.
2. Plug the memory stick into the USB socket.
3. Power cycle the controller and let the upgrade self-install.
4. Remove the memory stick and return the controller to production.

### 7.11 Fuses and Overcurrent Protection



**CAUTION**

The fuse detection circuit requires a continuous low level current through a high impedance bleed resistor to maintain the alarm condition.

As a result the load circuit is still connected to the mains voltage supply and it is not safe to attempt to repair or replace the fuse without first isolating the circuit.

There is a miniature circuit breaker that offers general overcurrent protection for the complete unit.

### 7.12 Replacement Fuses

If any fuse has ruptured, then ensure it is replaced with a new fuse that has identical characteristics. See Table 7-2, and Table 7-3 for the correct fuse types.

### 7.13 Supplementary Fuses

All the supplementary circuits (console supply, power supply, fans) are protected by a pair of fuses which are fed from the upper and lower supply busbars.

These are DIN-rail mounted and can be found inside the left side cover (viewed from the front) of an M1-48 and under the cover at the top on an M1-12.

Table 7-2 Supplementary Fuses	
Fuse	20 mm anti-surge
Rating	10 A

## 7.14 Controller Cards



### CAUTION

Only use ceramic body fuses on control cards. Never use glass bodied fuses.



Figure 7-1 Only use ceramic body fuses

The controller card has protection fuses for the heating load output.

Table 7-3 Output Fuse Type	
Fuse	32 mm Ceramic FF Ultra-Fast
Rating	15 A

# Section 8 - Troubleshooting

**WARNING**

Ensure that you have fully read "Section 3 - Safety" before troubleshooting any issues with the controller.

**CAUTION**

The fuse detection circuit requires a continuous low level current through a high impedance bleed resistor to maintain the alarm condition.

As a result the load circuit is still connected to the mains voltage supply and it is not safe to attempt to repair or replace the fuse without first isolating the circuit.

## 8.1 Introduction

The control system has several features that provide an early diagnosis of faults in the control system, the tool heaters and thermocouple sensors:

If the system detects any abnormal condition, it displays a warning message on the Main page.

If a zone temperature is seen to deviate from the actual setting beyond the alarm limits then the display will change to white text in red box and generate a remote alarm.

If the system detects a malfunction in one or more of the control zones, then it displays an error message on the Main page in place of a temperature value.

See "Table 8-1 Fault and Warning Messages" for more details.

Table 8-1 Fault and Warning Messages		
Error Message	Cause	Action
<b>ERR!</b>	<p>Little or no temperature rise has been detected in that zone.</p> <p>When the console starts to apply power it expects to see an equivalent heat rise at the thermocouple.</p> <p>If the thermocouple has been trapped and pinched in the tool or cable then the console cannot see the full heat rise that occurs at the tip. If left uncorrected there is a danger that the zone could overheat and damage the tip.</p> <p>The circuit maintains the output at whatever level it reached when the monitor circuit detected the fault.</p>	<ul style="list-style-type: none"> <li>• Check thermocouple wiring, as it may be reversed.</li> <li>• Heater wiring may be faulty or element may be open circuit.</li> </ul>
<b>FUSE</b>	<p>The output fuse for that zone has failed.</p> <p><b>IMPORTANT: Read hazard warnings at the start of Section 8.</b></p> <p><b>IMPORTANT:</b> A fuse can only fail due to a fault external to the controller. Identify and rectify the fault before replacing the fuse.</p> <p><b>Note:</b> If the fuse in question is mounted on a control card then it is safe to unplug the board in order to isolate the circuit and replace the fuse on the card.</p>	<ul style="list-style-type: none"> <li>• Replace the fuse with one of the same rating and type [High Rupture Current load fuse].</li> </ul> <p><b>NOTE:</b> The blown fuse is located on the control card.</p>
<b>GND</b>	<p>The system has detected an earth fault.</p>	<ul style="list-style-type: none"> <li>• Check the heater wiring for a low impedance path to earth.</li> </ul>
<b>LINE</b>	<p>No mains supply synchronization pulses being received.</p> <p>The three-phase supply is used in a crossover detection circuit to generate timing pulses for accurate phase control and firing the triac.</p> <p>If the phase detection fails on one or two phases then there is no pulse to use to measure phase angle and the LINE error message is generated.</p> <p>All circuits on the healthy phases will continue to work normally.</p>	<ul style="list-style-type: none"> <li>• There is a phase detection circuit on each card and a common phase detection circuit on all other controller types.</li> <li>• Although a fault in such circuits may cause the <b>LINE</b> error message, such fault is very rarely seen.</li> <li>• The most common error is either the absence of one phase or, if a plug has been rewired incorrectly, a swapped phase and neutral.</li> <li>• If a <b>LINE</b> error message occurs then switch off and isolate the controller and check supply wiring for presence of all three phases.</li> </ul>
<b>REV</b>	<p>The card has detected an abnormal input at the thermocouple termination that indicates a shorted or reversed thermocouple.</p>	<ul style="list-style-type: none"> <li>• If the <b>REV</b> alarm persists, switch off the controller and investigate the zone.</li> <li>• The offending zone can also be slaved to a good zone until the fault can be cleared.</li> </ul>



Table 8-1 Fault and Warning Messages		
Error Message	Cause	Action
<b>T/C</b>	An open circuit thermocouple has been detected and no auto-response has been selected in the TC Open Error column of the Setup page.	For immediate recovery: <ul style="list-style-type: none"><li>• slave that control zone to an adjacent zone OR change to open loop control</li><li>• When the controller is free, check to see whether the input fuse on the control card has ruptured.</li><li>• If the fuse is good, then check the wiring for faults or replace the thermocouple</li></ul>

## 8.2 Other Possible Fault Conditions



### **WARNING - SHOCK HAZARD**

The shrouded terminals on the Euroback board are live unless the power supply is switched to OFF.

### **8.2.1 Rapid Temperature Fluctuations**

The most likely cause of temperature fluctuations is extraneous voltages being picked up by the thermocouple cable, i.e. common mode. This may be due to poor earthing of the tool, a faulty shielded thermocouple wire or a faulty heater. We recommend that all earth connections be tested.

### **8.2.2 Ground Fault Detection**

Ground fault detection detects any fault caused by earth leakage current. Earth faults can occur if a tool has been idle for some time and damp has gotten into one heater. It may be possible to identify the heater and repair the faulty zone by using the adjacent heaters to heat it up and dry it out.

## **8.3 Module Removal**

To remove any control module from the controller, cabinet power must be isolated from the source.

# Section 9 - Wiring of Hot Runner Controller

**WARNING**

Ensure you have fully read "Section 3 - Safety" before connecting the controller.

**WARNING - HIGH VOLTAGE**

Please take extreme care when connecting the controller to the three-phase supply.

Do not change the supply wiring until the controller has been disconnected from all electrical supplies.

If you change the configuration from Star to Delta, then the neutral wire must be disconnected and made safe in order to protect from a live back feed.

**CAUTION**

Please take care with Star / Delta configuration since incorrect connection may appear to work but can result in damage to the controller.

The following standards only apply to controllers wired to *DME* standard. Other specifications may have been stated when the controller was ordered. Please refer to the supplied specification details.

## 9.1 Three Phase Designation - Star / Delta Option

The cabinet comes with a five-core mains 3-phase cable which may be used for either Star or Delta configuration. There are connectors within the case to change between Star and Delta supply.

At the upper connection blocks, located behind the left hand panel, change the Star / Delta cross-links using a single 3-way link for Star supplies or three 2-way links for Delta supplies. The connector strip shows the appropriate cross-links to use.

## 9.2 Set the Power Rail to the STAR Configuration



### WARNING

Before changing the wiring, pull down the breaker switch at the back of the controller to disconnect the controller from the power source.

1. Unscrew the terminal cover from the right side panel.
2. Remove the 6 position jumper from the terminal cover.

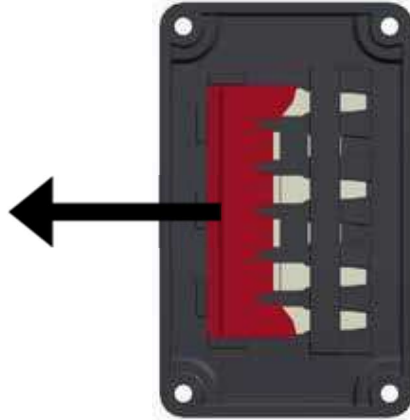

3. Remove the 3x2 position jumpers from the terminal block.

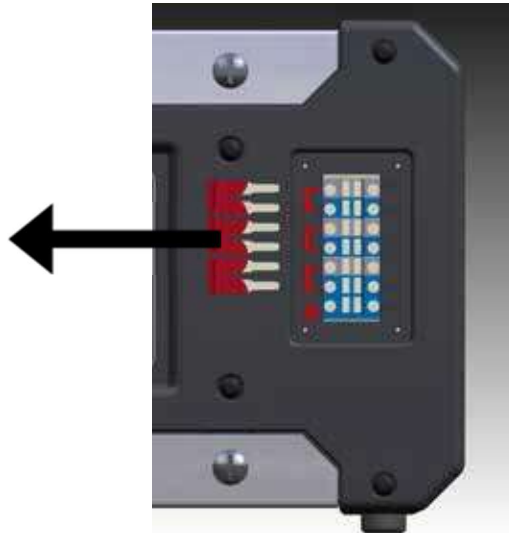

## WIRING OF HOT RUNNER CONTROLLER

4. Insert the 6 position jumper into the terminal block.

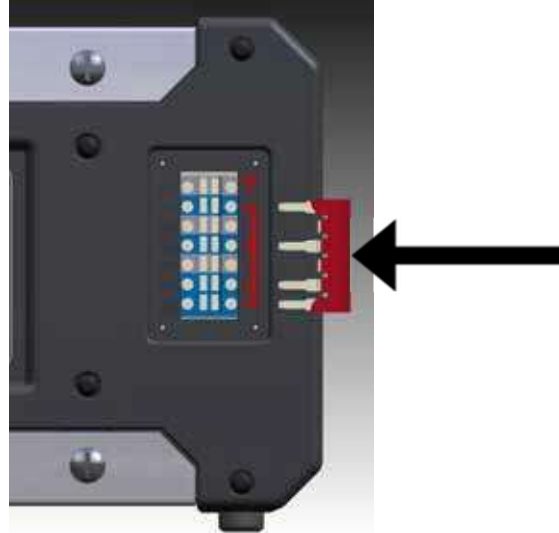

5. Place the 3x2 position jumpers in the terminal cover.

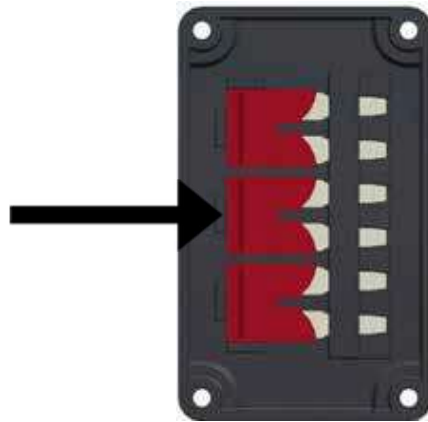

6. Screw the terminal cover onto the controller.

### 9.3 Set the Power Rail to the DELTA Configuration

**WARNING**

Before changing the wiring, pull down the breaker switch at the back of the controller to disconnect the controller from the power source.

1. Unscrew the terminal cover from the right side panel.
2. Remove the 3x2 position jumpers from the terminal cover.

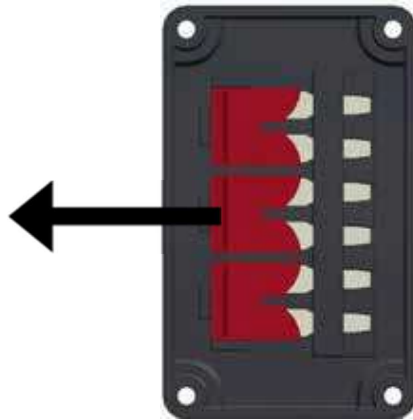

3. Remove the 6 position jumper from the terminal block

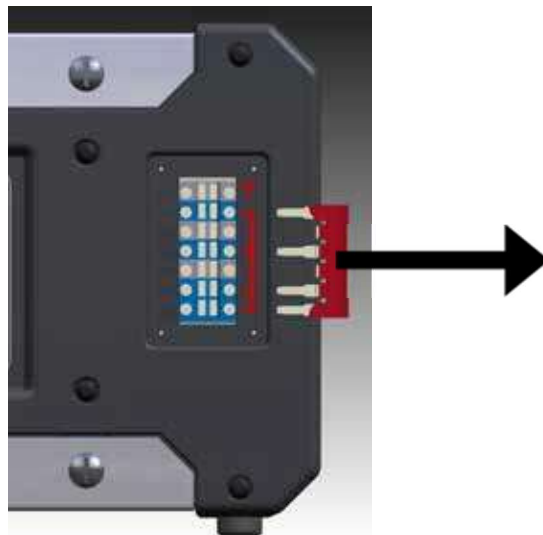

4. Insert the 3x2 position jumpers into the terminal block.

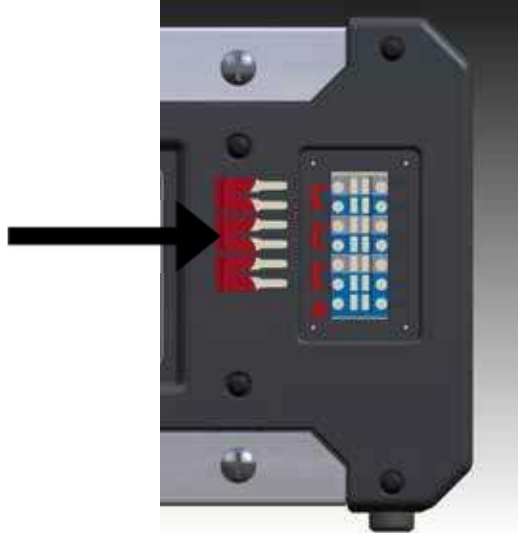

5. Place the 6 position jumper in the terminal cover.

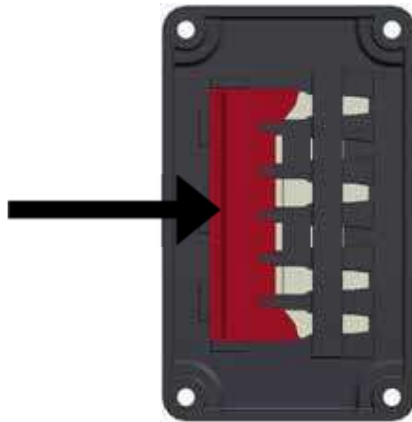

6. Screw the terminal cover onto the controller.

## 9.4 Filter Option

In countries where noise across power lines is a concern, *DME* recommends that an inline filter is fitted. Please contact *DME* for details.

## 9.5 Alarm Output / Auxiliary Input

An optional cabinet connector provides an alarm output from an internal set of relay contacts. Using an external power source the cabinet can initiate a number of warning devices whenever any zone goes into an alarm state. This is commonly used for beacons, audible alarms or informing the molding machine. In order to capture fleeting alarm conditions, the relay is held on for about 15 seconds after the alarm condition is cleared. The contacts are rated for 5 A at 240 V.

Pin	Connection	Input / Output
1	Auxiliary Input signal	Standby
2	Auxiliary Input Ground	
3	Alarm 240 V contact 1	Normally Open Contacts
4	Alarm 240 V contact 2	

An optional input can be accepted through the same connector. It may be used for Cycle Synch spear tips, Inhibit mode, remote Boost / Standby or any other user-definable function. For exact details, consult the specification for your particular model.

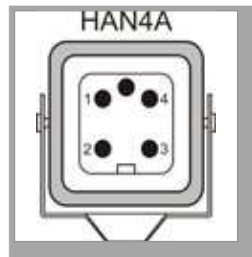

Figure 9-1 HAN4A connector



## 9.6 USB Port

A USB port is provided which enables certain functions such as:

- backup and restore tool settings
- save tool-test results

<b>Pin</b>	<b>Connection</b>
1	VCC
2	D-
3	D+
4	GND

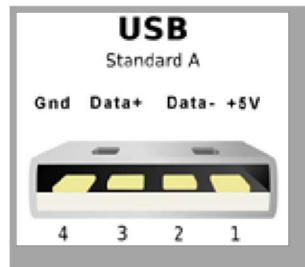

*Figure 9-2 USB port*

## 9.7 Standard Tool Connections

The diagrams below show the preferred standard for power and thermocouple connection cables. Custom controllers may differ and a custom wiring datasheet will be provided.

### 9.7.1 Connector for Me Controller

#### THERMOCOUPLE INPUT CONNECTOR

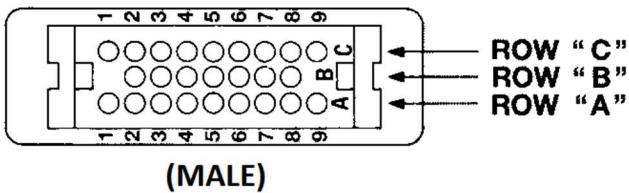

#### POWER OUTPUT CONNECTOR

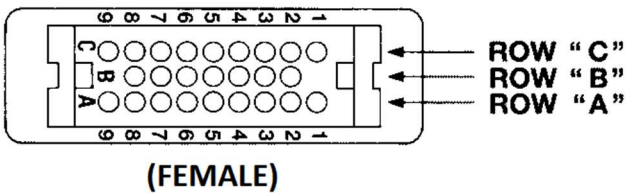

THERMOCOUPLE INPUT	
ZONE 1	ROW "A" TERMINALS 1 (WHT) + 2 (RED)
ZONE 2	ROW "A" TERMINALS 3 (WHT) + 4 (RED)
ZONE 3	ROW "A" TERMINALS 5 (WHT) + 6 (RED)
ZONE 4	ROW "A" TERMINALS 7 (WHT) + 8 (RED)
ZONE 5	ROW "B" TERMINALS 2 (WHT) + 3 (RED)
ZONE 6	ROW "B" TERMINALS 4 (WHT) + 5 (RED)
ZONE 7	ROW "B" TERMINALS 6 (WHT) + 7 (RED)
ZONE 8	ROW "C" TERMINALS 1 (WHT) + 2 (RED)
ZONE 9	ROW "C" TERMINALS 3 (WHT) + 4 (RED)
ZONE 10	ROW "C" TERMINALS 5 (WHT) + 6 (RED)
ZONE 11	ROW "C" TERMINALS 7 (WHT) + 8 (RED)
ZONE 12	ROW "A" TERM. 9 (WHT) ROW "C" TERM. 9 (RED)
ROW "B" TERMINAL 8 IS NOT USED	

POWER OUTPUT	
ZONE 1	ROW "A" TERMINALS 1 + 2
ZONE 2	ROW "A" TERMINALS 3 + 4
ZONE 3	ROW "A" TERMINALS 5 + 6
ZONE 4	ROW "A" TERMINALS 7 + 8
ZONE 5	ROW "B" TERMINALS 2 + 3
ZONE 6	ROW "B" TERMINALS 4 + 5
ZONE 7	ROW "B" TERMINALS 6 + 7
ZONE 8	ROW "C" TERMINALS 1 + 2
ZONE 9	ROW "C" TERMINALS 3 + 4
ZONE 10	ROW "C" TERMINALS 5 + 6
ZONE 11	ROW "C" TERMINALS 7 + 8
ZONE 12	ROW "A" + "C" TERMINALS 9
ROW "B" TERMINAL 8 IS NOT USED	



Figure 9-3 Rear View of Controller

# Index

## A

Alarm Extension 6-14  
Alarms 6-12

## B

Backing Up Tool Settings 6-21  
Boost Temperature 5-12

## D

Deleting a Tool 6-19

## F

Fuses 7-6  
Fuses and Overcurrent Protection 7-6

## G

Global Settings 5-4

## I

Interpreting the Test Results 7-4

## L

Language 5-3

## M

Main Page 4-4  
Manual Mode 6-9  
Mode Window 6-12  
Monitoring Temperature Limits 5-10

## O

Operating Modes 6-2

## R

Restoring Tool Settings 6-22

## S

Safety  
  Lockout 3-10  
Safety Instructions 3-1  
Screen Layout 4-3  
Screen Layout and Navigation 4-3  
Service and Repair 7-5  
Setting Boost Temperature 5-12  
Setting Password Control 5-19  
Setting Standby Value 5-14  
Standby Value 5-14  
Status Window 6-13

## T

Temperature Setting 5-8  
The Controller Cabinet 4-2

## U

User Interface 4-7

## Z

Zone Settings 5-6