



Process Controls

ACHIEVING OPTIMAL MOLDING
RESULTS WITH INJECTION PROCESS
CONTROLLERS, BUTTON SENSORS
AND SLIDE SENSORS



Process Controls



Portable Cavity and Hydraulic Pressure Monitor and Controller



- COMPACT AND SELF CONTAINED
- PROVIDES DIGITAL DISPLAY READOUT OF HYDRAULIC AND CAVITY PRESSURES
- PROVIDES AMPLIFIED OUTPUT OF PRESSURE SIGNAL
- 1 AMP RELAY OUTPUT FOR CONTROL OF BOOSTER PUMP CUTOFF
- PROVIDES EASY CALIBRATION OF D-M-E CONSTANT CALIBRATION SENSORS

The IPC-01-01 Injection Process Controller is a portable device that provides an inexpensive means of controlling peak plastics pressure in the mold. Peak pressure control is accomplished using a mold pressure sensor and a single setpoint to control filling and packing of the mold. By closely monitoring and controlling cavity pressure the user will reduce cycle time, reject rates and plastics usage. The controller operates the booster pump for the absolute minimum time required to fill and pack the cavities, significantly reducing electrical power consumption.

The IPC-01-01 controller uses a technique known as Dynamic Pressure Control (DPC). DPC maintains a more constant peak cavity pressure than machine timers and limit switches, regardless of plastic viscosity changes. This is accomplished by switching from High Volume (Fill) to Low Volume (Hold) injection at a predetermined cavity pressure.

Because of a direct correlation between peak cavity pressure and part weight (and therefore part size), accurate control of peak cavity pressure means more consistent part production.

Because part weight range can be reduced by using DPC, the average part weight can be reduced without occurrences of short shots. This translates into potential reduction in material usage. Increased repeatability in part weight also means less scrap as a result of short shots, over packed and flashed parts. Reducing these occurrences can also reduce associated wear and damage to tooling.

The IPC offers the three most requested features in a pressure monitor/controller:

1. Display of the pressure reading, including the peak pressure that occurred.
2. Amplification of the pressure signal for use by other equipment.
3. A relay contact set for direct control of the molding machine's booster pump cutoff function.

The IPC uses an injection signal or other switch closure to arm the holding of the peak pressure that occurred during the shot. The peak pressure reading is held until the end of the injection sequence.

A connector on the rear of the IPC provides the amplified pressure signal. A zero to 1, 2, 5, or 10 VDC (or 4 to 20 mA DC) signal directly corresponds to a zero to 20,000 PSI pressure. This signal can be routed to strip chart recorders, plant wide

monitors or other equipment. The signal can also be input into molding machines offering closed loop pressure control but that lack the necessary amplifiers for the sensing equipment.

The IPC offers a one amp, form C (normally open, normally closed) relay contact set for direct control of the machine's booster cutout function. The relay contacts are also gold plated for switching of low level signals such as the potentiometers used to set the machine's injection velocity. Many control relays are not capable of switching such sensitive signals. The relay contacts carry a voltage rating of up to 120 VAC.

The IPC is designed for use with D-M-E's Constant Calibration sensors but can be used with other manufacturers strain gage based sensors as well.

FRONT PANEL CONTROLS AND INDICATORS

The IPC offers quick easy calibration of pressure sensors via front panel adjustments. Calibration is quickly performed by pressing a push button and then adjusting the calibration setting.

A rotary switch allows for rapid selection of the pressure sensor and ejector pin size. A second rotary switch allows for selecting what is displayed: The pressure signal with peak hold, the pressure signal without peak hold or the DPC pressure setpoint.

A DPC light illuminates when the mold (or hydraulic) pressure reaches setpoint. This is an indication that the IPC's control relay has activated.

A toggle switch allows the user to override the control function while allowing for continued monitoring of pressures. A high accuracy ten-turn potentiometer allows for input of the pressure setpoint for booster cutout.

A three and one-half digit display allows for direct readout of pressures up to 19,990 PSI. This is displayed as pressure (times 10) for mold pressure.

A UL, CSA, VDE approved power switch allows the user to turn the IPC on and off from the front panel. Internal fuses (not shown) protect the unit from both sides of the AC line voltage. While the standard unit (IPC-01-01) is constructed for 120 VAC use, an optional IPC-01-02 is available. The unit is easily converted between 120 and 240 VAC operation. The 120 VAC unit comes with a standard wall outlet plug.

Portable Cavity and Hydraulic Pressure Monitor and Controller

OPERATION

The user plugs the IPC into a standard wall outlet. If machine control or automatic hold of the peak pressure signal is desired, a normally open relay contact is attached via the rear panel connector. If control of the machine is desired, the IPC's control relay is wired back to the machine via the same connector. A D-M-E pressure sensor is then attached via the rear panel and the unit is set to the appropriate pin size calibration. The pressure offset value is adjusted to zero with the front panel ZERO adjustment. The CAL push-button is pressed in and the CAL adjustment is then set for 8900 PSI. The user then sets IPC to the actual pin size being used and the IPC is ready to run. With the IPC set to MONITOR, the user notes and records the peak pressure obtained during acceptable part production. The SETPOINT is adjusted to 50 to 80% of the recorded peak. The user then places the IPC into the CONTROL mode and adjusts the SETPOINT until the desired peak pressure is achieved. It will be necessary to add time or distance to the machine's booster setting for the IPC to take control. The amplified signal output can be connected to process recording equipment or a molding machine's pressure signal input.

REAR PANEL (LEFT TO RIGHT)

Analog Output: is a standard 1/4 inch stereo headphone jack that outputs an amplified pressure signal of zero to 1, 2, 5 or 10 VDC (or 4 to 20 mA DC) corresponding to zero to 20,000 PSI.

D-M-E Sensor: accepts a D-M-E slide, or button sensor or related extension cable. Also accepts other sensors via a conversion cable.

Machine Interface: provides the injection forward and booster cutout wiring connections to the molding machine.

Power Input: provides 120 VAC (standard) or 240 VAC (optional) power for operation.



IPC-01-01 SPECIFICATIONS:

| | |
|--------------------------------|--------------------------------------------------------------------------------------------------------------------|
| Accuracy: | Analog output and digital display: $\pm 1\%$ full scale Setpoint: 0.8% of full scale |
| Repeatability: | Analog output and digital display: $\pm 0.5\%$ full scale Setpoint: 0-25% of full scale |
| Recorder Output: | Proportional to cavity pressure. Zero to 1, 2, 5 or 10 VDC (or 4 to 20 mA DC) corresponds to zero to 20,000 PSI |
| Control Span Range: | Zero to 20,000 PSI |
| Temperature Range: | 50° to 130°F |
| Power Required: | 115 VAC (105-125), 50-60Hz |
| Zero Drift, Analog Out: | Long Term: 0.1%/month, with temperature 0.1%/°F |
| Control Relay: | 1 amp, form C, 0-120 VAC, VDC |
| Injection Forward In: | normally open contact closure, less than 10 milliamps |
| Dimensions: | 7.2" wide, 2.7" high, 8.6" deep |

ORDERING INFORMATION

CONTROLLER

Includes 19 foot integral power cable, mating control and analog output connectors and two spare fuses. Pressure sensors and extension cables must be ordered separately.

| | |
|--------------------------|-------------------------------------|
| Catalog Numbers: | IPC-01-01 (120 VAC standard) |
| | IPC-01-02 (240 VAC optional) |
| Fuse Requirement: | (2) ABC-1 fuses |

SLIDE MOLD PRESSURE SENSORS

| | |
|-------------------------|------------------------------|
| Catalog Numbers: | SS-405C (500 pound)* |
| | SS-406C (2000 pound)* |

BUTTON MOLD PRESSURE SENSORS

| | |
|----------------------------|-------------------------------|
| Catalog Numbers: | BS-411C (125 pound) |
| | BS-412C (500 pound)* |
| | BS-413C (2000 pound)* |
| Requires Extension: | BSC-10 (10 foot cable) |

EXTENSION CABLES

| | |
|-------------------------|---------------------------------------------------------------|
| Catalog Numbers: | SSC-10 works with all sensors, 10' |
| | BSC-10 one req'd for button sensor |
| | SI-900 JIG box with 15' cable, works with all sensors. |

***NOTE:** 500 pound sensors are recommended for use with ejector pins from 1/16 to 3/16 inch diameters. 2000 pound sensors are recommended for use with ejector pins from 3/16 to 1/2 inch diameters. The 125 pound Sensor is recommended for 1/16 inch or less diameter pins.

DESIGNED, MANUFACTURED AND TESTED IN THE U.S.A.

U.S. 800-626-6653 ■ Canada 800-387-6600 ■ www.dme.net

Button Mold Pressure Sensors

Both Models Available in 12, 24 and 36 inch lengths



D-M-E Button Mold Pressure Sensors are used for measuring pressures in conjunction with auxiliary recording and control equipment in injection, die cast and transfer molds. They provide a full-scale output of 2 millivolts per volt of excitation.

Three Models

Available in 125, 500 and 2000 pounds force.

Hermetically Sealed

Allows sensor to be used where moisture is present.

Permanently Installed

Minimizes damage due to mishandling of sensors.

Temperature Compensated

Special amplifiers that compensate for temperature changes are avoided.

Constant Output

Because each sensor is electrically identical, each sensor has the same output. This similarity practically eliminates the need to recalibrate the readout system when sensors are exchanged. Only a slight readjustment of the zero setting of the readout system may be required when exchanging sensors. Therefore errors in calibration are non-existent and operators will spend less time setting up control systems and recorders.

Small Size

Suitable for small molds or molds where water lines, support pillars, etc., inhibit the use of slide sensors.

Installation

The Button Sensor is usually installed under an ejector pin and the shielded lead wire is run to the outside of the mold for mounting. To accommodate the button sensor, a slot and counterbored hole is machined into the ejector plate. See installation information for details.

NIST TRACEABLE
SUPPLIED WITH CERTIFICATE OF CALIBRATION

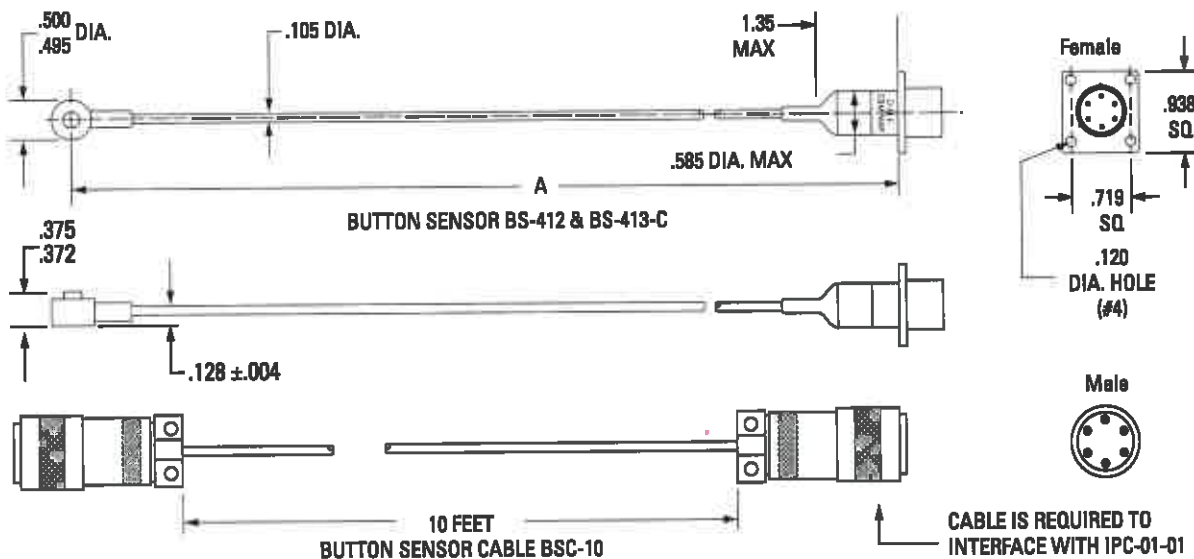

BUTTON MOLD PRESSURE SENSORS

Supplied with soldered on flush mount connector Amphenol PT02A10-6S (Mating connector Amphenol PT06A10-6P(SR) not supplied).

| FORCE POUNDS | MEASURES PRESSURE ON PINS FROM: | A LENGTH | | |
|--------------|---------------------------------|------------|------------|------------|
| | | 12" LEADS | 24" LEADS | 36" LEADS |
| 125 | 1/8 Thru 3/8 (1 Thru 3mm) dia. | BS-411C-12 | BS-411C-24 | |
| 500 | 1/8 Thru 3/8 (2 Thru 6mm) dia. | BS-412C-12 | BS-412C-24 | BS-412C-36 |
| 2000 | 3/8 Thru 1/2 (8 Thru 16mm) dia. | BS-413C-12 | BS-413C-24 | BS-413C-36 |

BUTTON SENSOR EXTENSION CABLE*

| ITEM NUMBER | LENGTH |
|-------------|---------|
| BSC-10 | 10 FEET |

*Mates with connector on button sensors above. Amphenol PT06A10-6P(SR) on each end. Use where required for monitoring and control equipment

Button Mold Pressure Sensors

INSTALLATION INFORMATION

FLUSH MOUNTED CONNECTOR

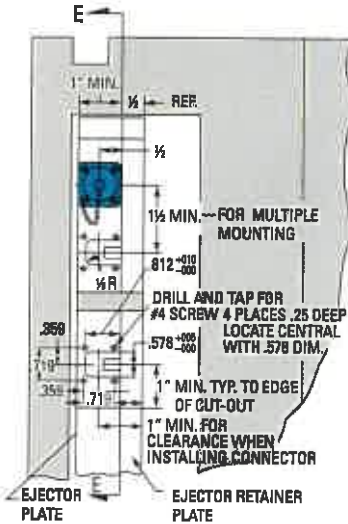

NOTE: When ejector plate is thicker than 1" connector may be centered on plate thickness. Altering mounting dimensions as required slot for lead wire should be depended as it approaches connector end as required.

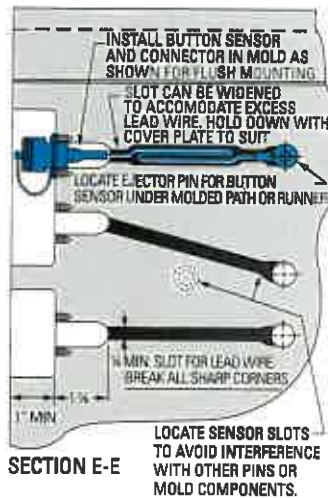

NOTE: When dummy pin installation is made. Altering mounting dimensions and location as required

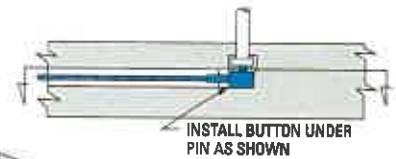
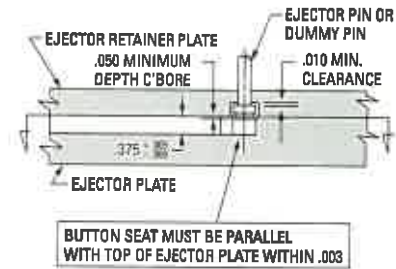
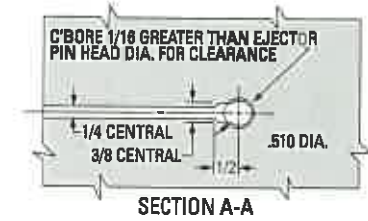

OUTSIDE BOX MOUNTED

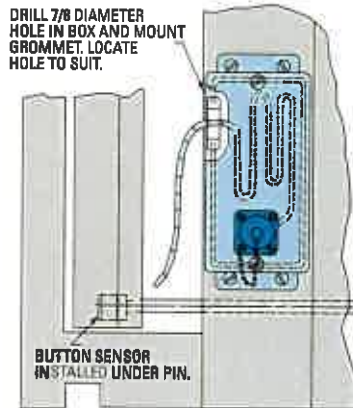

NOTE: When installing button sensor in mold pass button through hole in cover and hole in box before incorporating into mold under pin excess wire may be left in box.

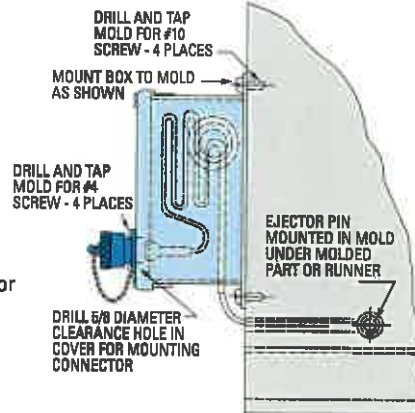

WIRING INFORMATION

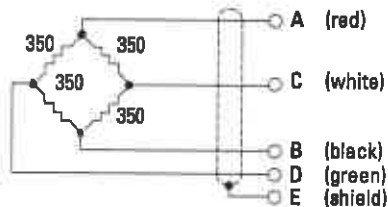

- + POWER A (red)
- POWER B (black)
- + SIGNAL C (white)
- SIGNAL D (green)
- GROUND E (shield)

WARNING:
DO NOT REMOVE CONNECTOR FROM SENSOR CABLE. CALIBRATION WILL BE ALTERED.

SPECIFICATIONS

| | | |
|---------------------------------|-------------------------------------|-----|
| PRESSURE MEASUREMENT RANGE..... | 0 to 20,000 psi | |
| (FOR RECOMMENDED PIN DIAMETERS) | | |
| FORCE RANGE | lb. | kg. |
| ITEM NO. BS-411C | 125 | 60 |
| ITEM NO. BS-412C | 500 | 225 |
| ITEM NO. BS-413C | 2000 | 900 |
| MAXIMUM LOAD..... | 150% FULL SCALE | |
| TEMPERATURE RANGE..... | 0°F to 450°F | |
| TEMPERATURE COMPENSATION | 2% FULL SCALE | |
| INPUT | 12V MAX. | |
| OUTPUT | 2.0 mV/V FULL SCALE | |
| ACCURACY..... | 3/4% FULL SCALE | |
| REPEATABILITY..... | 0.1% FULL RANGE OUTPUT | |
| FULL RANGE DEFLECTION | LESS THAN .0008" | |
| CIRCUIT | 4-ARM 350 OHM BRIDGE | |
| CONNECTOR | AMPHENOL PT02A10-6S | |
| | MATES WITH AMPHENOL PT06A10-6P (SR) | |

NOTE: MATING CONNECTOR IS AMPHENOL PT06A10-6P(SR).

Slide Mold Pressure Sensors

D-M-E Slide Mold Pressure Sensors are used for measuring pressures in conjunction with auxiliary recording and control equipment in injection and transfer molds. They provide a constant, full-scale output of 2 millivolts per volt. Because each sensor is electrically identical, the need for recalibration of control systems or recorders when a sensor is replaced is virtually eliminated. This means that errors in calibration are non-existent and operating personnel will now have an easier time setting up and operating control systems and recorders.

Constant Output

All sensors have the same output. This eliminates the need to recalibrate the readout system when sensors are exchanged.

Hermetically Sealed

Allows the sensor to be used at low temperatures where moisture is a problem.

Temperature Compensated

Special amplifiers are eliminated to compensate for temperature changes.



Easily Removed

Allows user to take sensor from one mold and place in another.

Two Models

Covers ejector pin sizes from 1/16" to 1/2" diameter, eliminating the need for stocking several different load ranges.

Installation

The sensing element is housed in a rectangular slide that plugs into a 3/8" deep by 1/2" wide slot, machined from the edge of the ejector plate to an ejector pin (slot machined in support plate when using a dummy pin). When fully inserted, the sensing element of the slide is under the head of the pin. See installation information for details.

NIST TRACEABLE
SUPPLIED WITH CERTIFICATE OF CALIBRATION

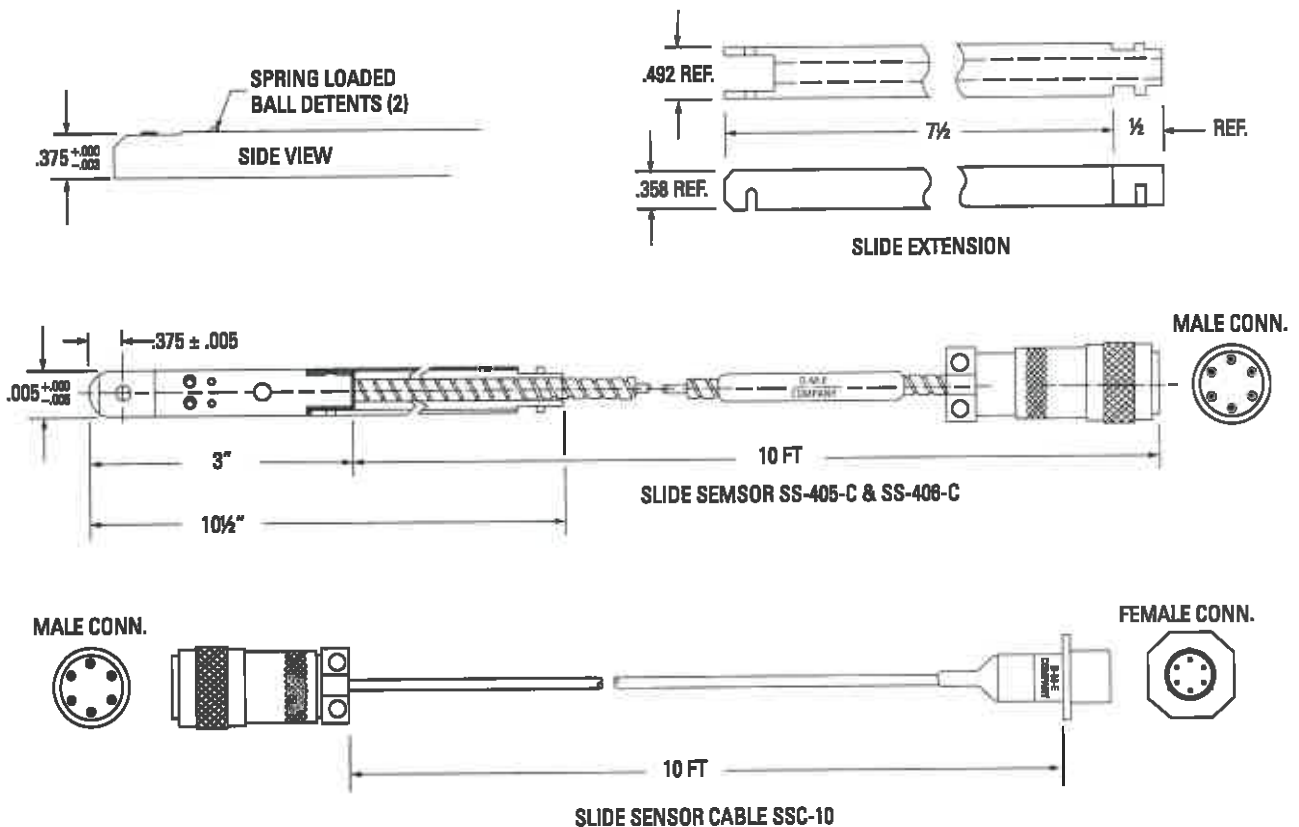

Slide Mold Pressure Sensors

INSTALLATION INFORMATION

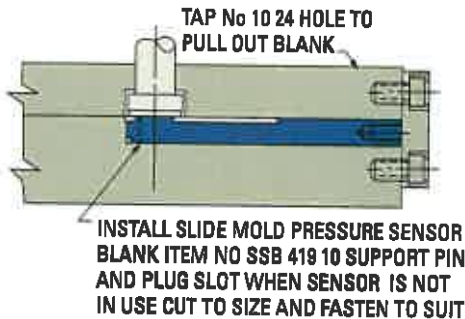
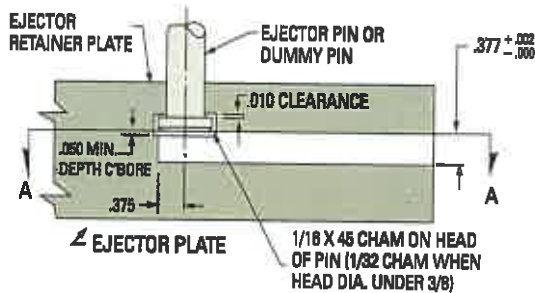
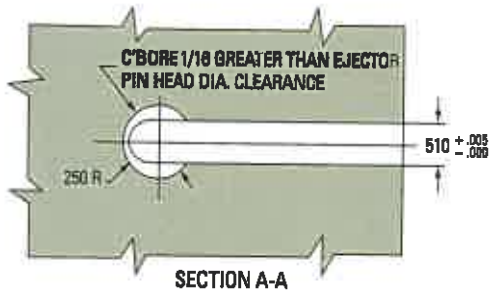

SLIDE MOLD PRESSURE SENSORS

| ITEM NUMBER | MEASURES PRESSURES ON PINS FROM: |
|-------------|----------------------------------|
| SS-405C | 1/8 THRU 3/8 (2 THRU 6mm) Dia. |
| SS-406C | 3/8 THRU 1/2 (6 THRU 16mm) Dia. |

SIDE EXTENSION

| ITEM NUMBER | LENGTH |
|-------------|--------|
| SSE-418 | 7 1/2" |

SENSOR BLANK

| ITEM NUMBER | LENGTH |
|-------------|--------|
| SSB-419 | 12" |

SLIDE SENSOR EXTENSION CABLE**

| ITEM NUMBER | LENGTH |
|-------------|--------|
| SSC-10 | 10 ft. |

**Mates with connector on slide sensors above. Has Amphenol connector No. PT01A10-6S(SR) on one end and Amphenol connector No. PT06A10-6P(SR) on the other end. Use where required for monitoring and control equipment.

WIRING INFORMATION

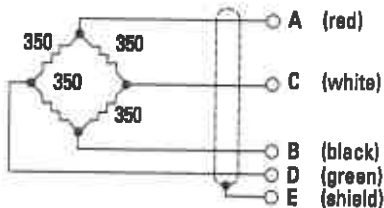

- + POWER A (red)
- POWER B (black)
- + SIGNAL C (white)
- SIGNAL D (green)
- GROUND E (shield)

WARNING:
DO NOT REMOVE CONNECTOR FROM SENSOR CABLE. CALIBRATION WILL BE ALTERED.

SPECIFICATIONS

| | |
|---------------------------------|------------------------------------|
| PRESSURE MEASUREMENT RANGE..... | 0 to 20,000 psi |
| (FOR RECOMMENDED PIN DIAMETERS) | |
| FORCE RANGE..... | lb. kg. |
| ITEM NO. SS-405C | 500 225 |
| ITEM NO. SS-406C | 2000 900 |
| MAXIMUM LOAD..... | 150% FULL SCALE |
| TEMPERATURE RANGE..... | 0°F TO 450°F |
| TEMPERATURE COMPENSATION | 2% FULL SCALE/100°F |
| INPUT | 12V MAX. |
| OUTPUT | 2.0 mV/V FULL SCALE |
| ACCURACY..... | 3/4% FULL SCALE |
| REPEATABILITY..... | 0.1% FULL RANGE OUTPUT |
| FULL RANGE DEFLECTION | LESS THAN .0008" |
| CIRCUIT | 4-ARM 350 OHM BRIDGE |
| CABLE LENGTH | 10 FEET |
| CONNECTOR | AMPHENOL PT06A10-6P(SR) |
| | MATES WITH AMPHENOL PT01A10-6S(SR) |

Using Process Controls and Monitoring to Achieve Optimal Molding Results

Ensuring part quality —
everytime.

Short Shot

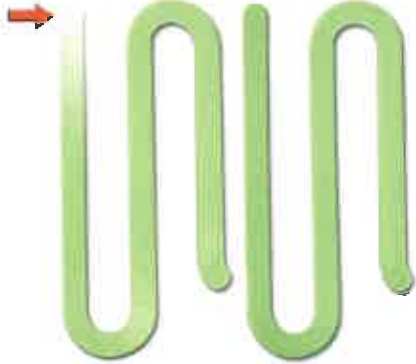

D-M-E button sensors, slide sensors and injection process controllers can be used for a number of applications. Assuming one is using newer injection molding machine technology with 3-stage control, managing the peak cavity pressure during pack (2nd stage) will guarantee consistent part quality. Peak cavity pressure determines how much plastic is injected into the part. Having consistent peak pressure during injection, shot after shot, guarantees that all parts in production are of the same size. This is referred to as process control.

Another application is that of process monitoring. By placing an ejector pin and a sensor at the last location in the part to fill, the sensor can be used to determine whether a short shot occurred. By determining the minimum pressure that defines a filled part, monitoring the process can determine whether a short shot has occurred. Many molders have used this method to scrap a suspected bad part because they would rather risk scrapping a good part than supplying a defective part to their customer. This is a fairly common practice for molders supplying certain industries, including automotive.

Many customers use D-M-E sensors in conjunction with plant-wide monitoring systems to automatically control conveyors. If a specific range of cavity pressure is not realized during ejection, the part is automatically scrapped. Again, this practice of scrapping a potentially good part rather than supplying a bad part to a customer ensures that part quality remains consistently good.

The D-M-E Injection Process Controller (IPC) can operate in a couple different ways. It can act as an amplifier to supply zero to one, zero to five, or zero to 10 volts DC. It can also output a four to 20 milliamp signal. If the molding machine has cavity pressure control but no strain gauge amplifier, the IPC can be used to fill the void. The IPC can also accept a relay contact closure indicating that injection forward is occurring. It can then use a pressure setpoint to trigger a relay contact to inform the molding machine that a specific cavity pressure has occurred. This action instructs the molding machine to go into a hold (3rd stage) state. Since there is a slight delay in triggering the machine, a slightly lower setpoint is used than the peak pressure.

The injection signal into the IPC also triggers a peak hold circuit so that peak cavity pressure is maintained on the display of the IPC until the end of injection.

For more information about setting up process control and monitoring applications, visit www.dme.net.