

DME EZ-FIT

HI-TEMPERATURE/BLIND HOLE INSERTS



DME Complete
Thermal Management

PRODUCTIVITY BOOSTER

Easy Access, Reduced Down Time & Increased Productivity

- Withstands temperatures up to 644°F (340°C) enabling **use with a broader selection of resins**
- Faster easier way to insert & remove inserts thus saving hours in production and down time every year.
- Designed to be easily removed from cavity plate with a small screw driver and a metric screw, **no need for a thru-hole**
- Newly engineered inner inserts are removable with fewer rotations due to shorter threads (not compatible with other DME inserts)
- Inner inserts use ball detents to click into position



DME EZ-FIT

HI-TEMPERATURE/BLIND HOLE INSERTS



SMALL PACKAGE LARGE THERMAL IMPACT

Design Your Mold With Maximum Thermal Management in Mind

- Improves cycle time due to engineering freedom of the water line placement
- DME's Hi-Temp inserts are rated at more than twice the max temp of our standard inserts
- Blind hole inserts allow the designer to route cooling lines closer to the core where cooling is critical
- Traditional inserts require a knockout hole to be machined for removal which limits cooling channel location and size. Hi-Temp/Blind Hole inserts maximize design and cooling location options.
- Specific resins require high heat and longer cycle times. Choose the insert that stands up to the heat and allows for optimal cooling for improved cycle times.

Traditional Method: Eject insert with pin from back of cavity plate. Knockout hole impedes water line design & hampers effective part cooling design.

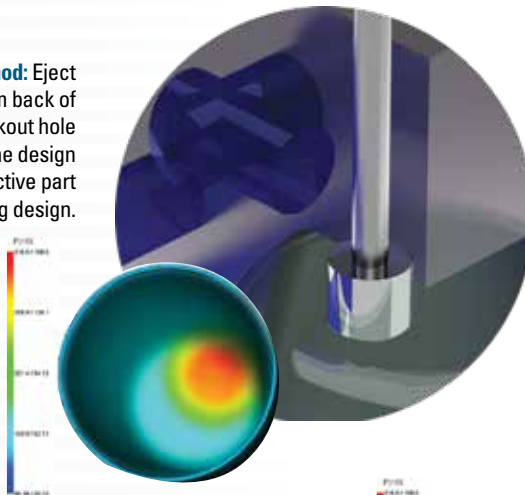

1 Traditional
Traditional style insert with traditional cooling. Insert knockout hole hampers cooling channel design.



2 Better
Traditional cooling channel is optimized with Hi-Temp/Blind hole insert. Greater channel flexibility with Blind Hole application.



3 Best
Conformal Cooling at its most optimal placement to provide cycle time reduction and improved part quality, due to blind hole insert technology.



TruCool
MOLD COOLING SOLUTIONS

Blind Hole: Absence of a knockout hole allows designers the freedom to place water lines in optimal locations for effective cooling, and reduced cycle time.

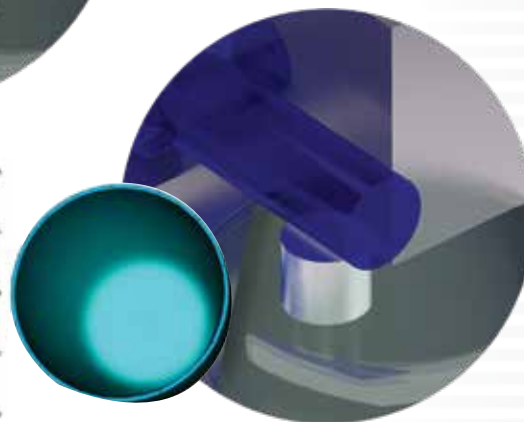

Example of savings from improved cycle time.

	Traditional	Blind Hole	Improvement
Number of Units / Year	1,472,688	1,534,050	61,362
Cycle (seconds)	25.0	24.5	0.5
Cycles / year	736,344	767,025	30,681
Additional Cost / Mold	0	\$30*	0
Total Gain / Savings	\$0	\$67,025	\$4,196

* Represents two inserts in a 2-cavity mold.

HI-TEMPERATURE/BLIND HOLE INSERTS

Dimensions and Tolerances of EZ-FIT High-Temperature Inserts

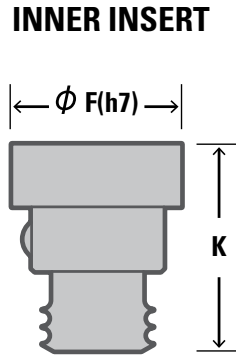
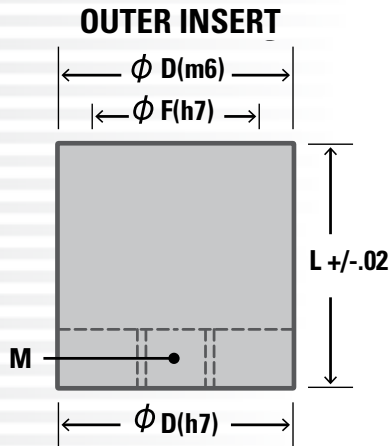

Material: Stainless Steel
Hardness: 50-55 HRC
Max. Temp: 340°C (644°F)
Dimensions: All dimensions are in mm, except as noted



Labor Savings

Easy to remove the complete insert with cap screw from mold **while still in the press**



Faster Cycle Times

The Blind Hole design provides optimal cooling capabilities which are perfect for reduced cycle time in high heat application



Broader Resin Choice

This NEW date insert can stand the heat. With a temperature rating up to 644°F this insert will cover almost any application

OUTER INSERT				INNER INSERT		TOLERANCES	
Ø D (m6)	Ø F (h7)	L	M	Ø F (h7)	K	Ø D (m6)	Ø D (h7)
4	2.6	8	M1.8	2.6	5.5	+0.012 TO +0.004	0 TO -0.012
6	4	8	M2.5	4	5.5	+0.012 TO +0.004	0 TO -0.012
8	5.0	10	M3	5.0	7.1	+0.015 TO +0.006	0 TO -0.015
10	6.3	12	M3	6.3	8.8	+0.015 TO +0.006	0 TO -0.015
12	7.5	14	M4	7.5	9.8	+0.018 TO +0.007	0 TO -0.018
16	11.0	14	M5	11.0	9.8	+0.018 TO +0.007	0 TO -0.018
20	13.2	16	M5	13.2	11.8	+0.008 TO +0.021	0 TO -0.021

See Indexable and Front Removable pages for installation and machining instructions.

EZ-FIT Size Options (to scale)

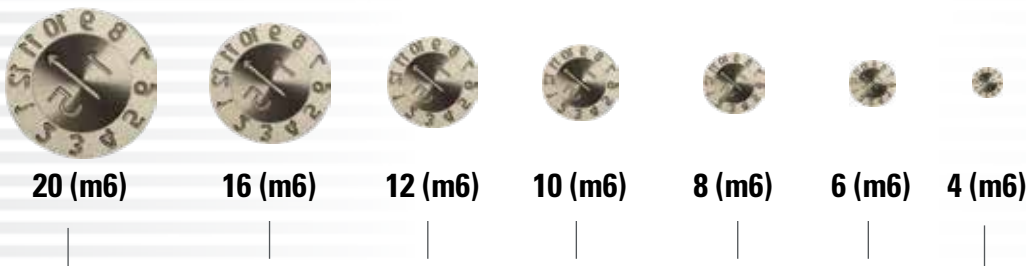





HI-TEMPERATURE/BLIND HOLE INSERTS

Ordering Information

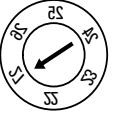
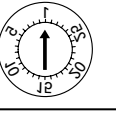
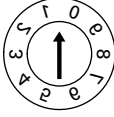
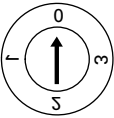
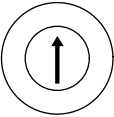

Complete Assemblies Features

DESCRIPTION	Ø D (mm)	ITEM NUMBER
 Month (outer), Year and Arrow (inner)	4	HTYM_*_04
	6	HTYM_*_06
	8	HTYM_*_08
	10	HTYM_*_10
	12	HTYM_*_12
	16	HTYM_*_16
20	HTYM_*_20	
 Month (outer), Arrow (inner)	4	HTOM0004
	6	HTOM0006
	8	HTOM0008
	10	HTOM0010
	12	HTOM0012
	16	HTOM0016
20	HTOM0020	
 (6) Years (outer), Arrows (inner)	4	HTOY_*_04
	6	HTOY_*_06
	8	HTOY_*_08
	10	HTOY_*_10
	12	HTOY_*_12
	16	HTOY_*_16
20	HTOY_*_20	
 Day (outer), Arrow (inner)	12	—
	16	HTOD0016
	20	HTOD0020
 "Numerals" 0 thru 9 (outer) Arrow (inner)	4	HTOR0004
	6	HTOR0006
	8	HTOR0008
	10	HTOR0010
	12	HTOR0012
	16	HTOR0016
20	HTOR0020	
 "Shift" (outer), Arrow (inner)	4	HTOS0004
	6	HTOS0006
	8	HTOS0008
	10	HTOS0010
	12	HTOS0012
	16	HTOS0016
20	HTOS0020	
 Blank (outer), Arrow (inner)	4	HTOB0004
	6	HTOB0006
	8	HTOB0008
	10	HTOB0010
	12	HTOB0012
	16	HTOB0016
20	HTOB0020	

NOTES:

- When ordering date-sensitive assemblies, add digits of engraved year requested where asterisks (*) are shown in item number (e.g., UUY1816).
- Availability of year-sensitive items will vary during the last quarter of each calendar year. Order next year's Mold Date Inserts during October to beat the rush.

Inner Inserts Features

DESCRIPTION	OUTER RING Ø D (MM)	ITEM NUMBER
 Year and Arrow	4	HTYA_*_04
	6	HTYA_*_06
	8	HTYA_*_08
	10	HTYA_*_10
	12	HTYA_*_12
	16	HTYA_*_16
20	HTYA_*_20	
 Arrow	4	HTIA0004
	6	HTIA0006
	8	HTIA0008
	10	HTIA0010
	12	HTIA0012
	16	HTIA0016
20	HTIA0020	

Outer Inserts Features

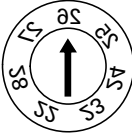
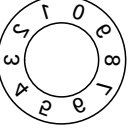
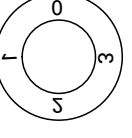
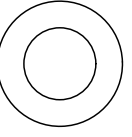
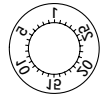





DESCRIPTION	Ø D (mm)	ITEM NUMBER
 Month (1 thru 12)	4	HTUM0004
	6	HTUM0006
	8	HTUM0008
	10	HTUM0010
	12	HTUM0012
	16	HTUM0016
20	HTUM0020	
 (6) Years	4	HTUY_*_04
	6	HTUY_*_06
	8	HTUY_*_08
	10	HTUY_*_10
	12	HTUY_*_12
	16	HTUY_*_16
20	HTUY_*_20	
 "Numerals" (0 thru 9)	4	HTUR0004
	6	HTUR0006
	8	HTUR0008
	10	HTUR0010
	12	HTUR0012
	16	HTUR0016
20	HTUR0020	
 "Shift" (0 thru 3)	4	HTUS0004
	6	HTUS0006
	8	HTUS0008
	10	HTUS0010
	12	HTUS0012
	16	HTUS0016
20	HTUS0020	
 Blank	4	HTUB0004
	6	HTUB0006
	8	HTUB0008
	10	HTUB0010
	12	HTUB0012
	16	HTUB0016
20	HTUB0020	
 Day	16	HTUD0016
	20	HTUD0020

BLIND-HOLE APPLICATION INSERTS



Features & Benefits

- Patented mold date insert design
- Install into cavity plate with insert's captured screw
- Thru hole not required for removal
- Changes or removal while mold is in the press
- Available in 6mm, 10mm and 16mm diameters (others via special order)
- Compatible with standard Indexable DME inner inserts







Complete Assemblies Features

DESCRIPTION	Ø D (mm)	ITEM NUMBER
 Month / Year / Arrow	6	UYM_*_06S
	10	UYM_*_10S
	16	UYM_*_16S
 Month / Arrow	6	UOM0006S
	10	UOM0010S
	16	UOM0016S
 (6) Years	6	UOY_*_06S
	10	UOY_*_10S
	16	UOY_*_16S
 0 thru 9 / Arrow	6	UOR0006S
	10	UOR0010S
	16	UOR0016S
 "Shift" / Arrow	6	UOS0006S
	10	UOS0010S
	16	UOS0016S
 Blank / Arrow	6	UOB0006S
	10	UOB0010S
	16	UOB0016S
 Day / Arrow	16	UOD0016S

Indexable Inner Inserts Features

DESCRIPTION	Ø D (mm)	ITEM NUMBER
 Year and Arrow	6	YUU_*_06
	10	YUU_*_10
	16	YUU_*_16
 Arrow	6	O UU0006
	10	O UU0010
	16	O UU1106

Outer Inserts Features

DESCRIPTION	Ø D (mm)	ITEM NUMBER
 Month (1 thru 12)	6	UUM0006S
	10	UUM0010S
	16	UUM0016S
 (6) Years	6	UUY1206S
	10	UUY1210S
	16	UUY1216S
 "Numerals" (0 thru 9)	6	UUR0006S
	10	UUR0010S
	16	UUR0016S
 "Shift" (0 thru 3)	6	UUS0006S
	10	UUS0010S
	16	UUS0016S
 Blank	6	UUB0006S
	10	UUB0010S
	16	UUB0016S
 Day	16	UUD0016S

NOTES:

1. When ordering date-sensitive assemblies, add digits of engraved year requested where asterisks (*) are shown in item number (e.g., UUY1816).
2. Availability of year-sensitive items will vary during last quarter of each calendar year. Order next year's Mold Date Inserts during October to beat the rush.

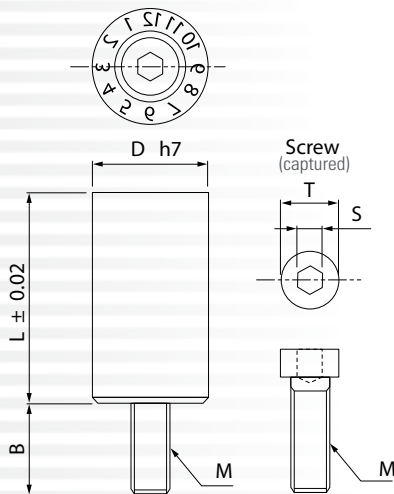

Indexable Date Insert with Screw Type Fastener

Date Inserts – Material: SUS420 Hardness: 50-53 HRC
 Screw Part – Material: SCM435 Hardness: 32-39 HRC
 Maximum operating temperature 150°C (300°F)

		Dia (mm)		
D h7	Date insert diameter	6mm	10mm	16mm
	Dia tolerance	0,-0.012mm	0,-0.015mm	0,-0.018mm
L	Length	11mm	15mm	18mm
B	Bolt length (screw L)	4.7mm	4.5mm	5.8mm
T	Bolt diameter	3mm	5mm	7.5mm
S	Hexagon wrench size	1.27mm	1.5mm	3mm
M	screw pitch size	M2 X P 0.4	M3 X P 0.5	M5 X P 0.8

DUAL-RING INSERTS

Dual-Ring Mold Dating Insert Offers the Ultimate in Date Insert Flexibility

Patented Indexable Mold Date Insert Technology

The Dual-Ring Mold Date Insert from DME features a date insert identification valid for six years and is based on Indexable Mold Date Insert technology.

The Dual-Ring Insert eliminates the need to install two date inserts or change the inner insert each year. This easy-to-use indexable insert provides the flexibility you need to keep your mold dates current for up to six years.

Features and Benefits

- Outer ring: 12 months, months 1 through 12
- Inner ring: 6 years + arrow (arrow points to month)
- Center insert: arrow (points to year & adjusts position of both arrows)
- Double indexable: both arrows independently “click into position”
- Arrow utilized as adjustment slot
 - Turn clockwise to change “year” arrow (6 years)
 - Turn counter-clockwise to change “month” arrow (12 months)
- All inserts remain flush when rotated
- Dual-Ring Insert may be interchanged for the 20mm, 16mm, 10mm, 8mm to 6mm diameter Indexable and Front Removable inserts



Installation and Machining

- Press-fit installation required
- Maintain a close tolerance press fit.
 - Too loose a fit could allow the insert to move out of position
 - Too tight of a press fit might prevent the inner insert and inner ring from rotating when required.
- $\varnothing G$: accurately measure the $\varnothing D$ for each part and machine $\varnothing G$ hole to provide 0.005mm (.0002") press fit.
- Accurately measure insert “L”
- Provide “L” pocket to be flush

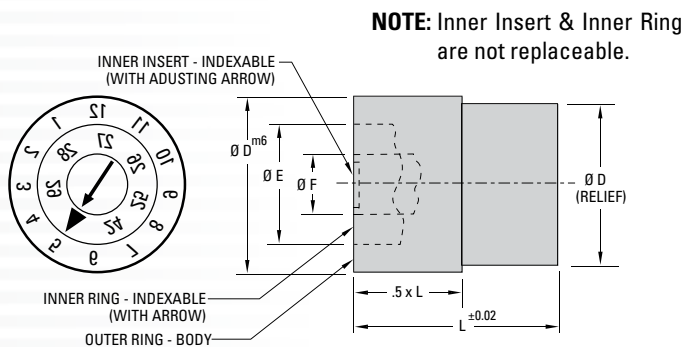

Pocket for installation (hold pocket depth as required by the application)

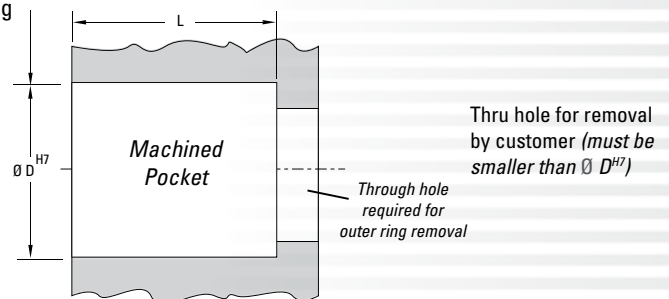

$\varnothing D$	TOLERANCE	
	M6	H7
6	+0.004 TO +0.012	0.000 TO -0.012
8	+0.006 TO +0.015	0.000 TO -0.015
10	+0.006 TO +0.015	0.000 TO -0.015
16	+0.007 TO +0.018	0.000 TO -0.018
20	+0.008 TO +0.021	0.000 TO -0.021

INFORMATION KEY:

D = Outside Diameter
E = Outside Diameter of Inner Ring
F = Outside Diameter of Inner Insert
G = Hole Diameter
L = Length
Material: Corrosion-resistant Stainless Steel
Hardness: 53 ± 3 HRC
Max. Temp: 150°C (300°F)
Dimensions: All dimensions are in mm, except as noted

Dual-Ring Mold Dating Insert – MD Dimensions and Assembly

ITEM NUMBER	$\varnothing D$	$\varnothing E$	$\varnothing F$	L LENGTH
MD 20 20_*	20	12.8	6.2	16
MD 16 20_*	16	10.6	5	14
MD 10 20_*	10	6.4	3.2	12
MD 08 20_*	8	5.3	2.5	10
MD 06 20_*	6	3.8	1.8	10

* When ordering, add digits of engraved year required where asterisks (*_) are shown in item number (e.g., MD 10 20_* : MD 10 2013; MD 10 20_* : MD 10 2018).

INDEXABLE AND FRONT REMOVABLE INSERTS

Indexable Inserts

U.S. Patent No. 5,788,872

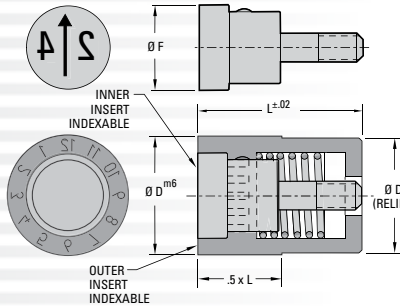

NOTE: Indexable springs are built in.

Features & Benefits

- Front removable inserts have a replaceable spring to help keep the inner insert from moving during molding.
- Indexable inserts have “captured spring” in the outer insert and a ball detent on the inner insert to help lock the inner insert in place.
- Arrow functions as adjustment slot
- Easily replace or adjust the inner insert while mold is in the press.
- Numerals are 0.2mm deep and arrow is 0.4mm deep

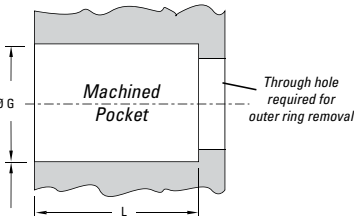

- Relief on bottom of insert will align insert into hole.
- An aluminum rod should be placed against the face of the insert with the rod larger in diameter than the Outer Insert. The aluminum rod should be tapped with a hammer to move the insert to its flush position.
- Inner insert must be flush or below flush during installation.

Installation and Machining for Both Insert Styles

- Press-fit installation required
- Maintain a close tolerance press fit.
 - Too loose a fit could allow the insert to move out of position
 - Too tight of a press fit might prevent the inner insert and inner ring from rotating when required.
- $\varnothing G$ accurately measure the $\varnothing D$ for each part and machine $\varnothing G$ hole to provide 0.005mm (.0002”) press fit.
- Accurately measure insert “L”
- Provide “L” pocket to be flush

Front Removable Inserts

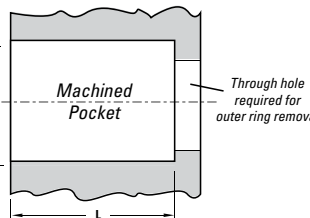
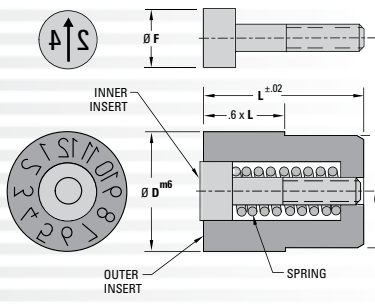

- Relief on bottom of insert will align insert into hole.
- An aluminum rod should be placed against the face of the insert with the rod larger in diameter than the Outer Insert. The aluminum rod should be tapped with a hammer to move the insert to its flush position.
- Inner insert must be flush or below flush during installation.

INFORMATION KEY:

D = Outside Diameter of Outer Insert

F = Outside Diameter of Inner Insert

G = Hole Diameter

L = Length

Material: Stainless Steel

Hardness: 50-55 HRC

Max. Temp: 150°C (300°F)

Dimensions: All dimensions are in mm, except as noted

Dimensions and Tolerances of Indexable & Front Removable Inserts

Ø D	TOLERANCE		L	Ø F INDEXABLE INDEX	Ø F FRONT REMOVABLE
	M6	H7			
4	+0.012 TO +0.004	0 TO -0.012	8	2.4	—
6	+0.012 TO +0.004	0 TO -0.012	8	3.7	3.1
8	+0.015 TO +0.006	0 TO -0.015	10	5.0	4.4
10	+0.015 TO +0.006	0 TO -0.015	12	6.3	5.2
12	+0.018 TO +0.007	0 TO -0.018	14	7.5	6.2
16	+0.018 TO +0.007	0 TO -0.018	14	11.0	8.2
20	+0.021 TO +0.008	0 TO -0.021	16	13.2	11

All dimensions and tolerances are in millimeters (mm).

toll-free U.S. 800-626-6653 • toll-free Canada 800-387-6600
DME.net • DME@DME.net • store.DME.net

Application

Produce & Track

Endless options and configurations for production & product tracking.



Dependable Traceability

Whether the day, month or year your production and parts have the date needed for traceability.



Front Removable Springs





ITEM NUMBER (PACKAGE OF 5)	Ø D
DFQ9006	6
DFQ9008	8
DFQ9010	10
DFQ9012	12
DFQ9016	16
DFQ9020	20

NOTE: Springs are for Front Removable Inserts only.

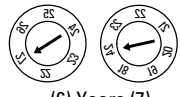

INDEXABLE AND FRONT REMOVABLE INSERTS

Ordering Information

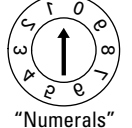
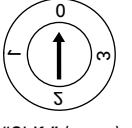
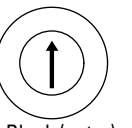
Complete Assemblies Features

DESCRIPTION	Ø D (mm)	ITEM NUMBER INDEXABLE	ITEM NUMBER FRONT REMOVABLE
 Month (outer), Year and Arrow (inner)	4	UYM_*_04	—
	6	UYM_*_06	FYM_*_06
	8	UYM_*_08	FYM_*_08
	10	UYM_*_10	FYM_*_10
	12	UYM_*_12	FYM_*_12
	16	UYM_*_16	FYM_*_16
 Month (outer), Arrow (inner)	4	UOM0004	—
	6	UOM0006	FOM0006
	8	UOM0008	FOM0008
	10	UOM0010	FOM0010
	12	UOM0012	FOM0012
	16	UOM0016	FOM0016
Indexable Front Removable  (6) Years (7) Years (outer), Arrows (inner)	4	UOY_*_04	—
	6	UOY_*_06	FOY_*_06
	8	UOY_*_08	FOY_*_08
	10	UOY_*_10	FOY_*_10
	12	UOY_*_12	FOY_*_12
	16	UOY_*_16	FOY_*_16
 Day (outer), Arrow (inner)	12	—	FOD0012
	16	UOD0016	FOD0016
	20	UOD0020	FOD0020
 "Numerals" 0 thru 9 (outer) Arrow (inner)	4	UOR0004	—
	6	UOR0006	FOR0006
	8	UOR0008	FOR0008
	10	UOR0010	FOR0010
	12	UOR0012	FOR0012
	16	UOR0016	FOR0016
 "Shift" (outer), Arrow (inner)	4	UOS0004	—
	6	UOS0006	FOS0006
	8	UOS0008	FOS0008
	10	UOS0010	FOS0010
	12	UOS0012	FOS0012
	16	UOS0016	FOS0016
 Blank (outer), Arrow (inner)	4	UOB0004	—
	6	UOB0006	FOB0006
	8	UOB0008	FOB0008
	10	UOB0010	FOB0010
	12	UOB0012	FOB0012
	16	UOB0016	FOB0016
20	UOB0020	FOB0020	

Inner Inserts Features

DESCRIPTION	OUTER RING Ø D (MM)	ITEM NUMBER INDEXABLE	ITEM NUMBER FRONT REMOVABLE
 Year and Arrow	4	YUU_*_04	—
	6	YUU_*_06	YON_*_06
	8	YUU_*_08	YON_*_08
	10	YUU_*_10	YON_*_10
	12	YUU_*_12	YON_*_12
	16	YUU_*_16	YON_*_16
	20	YUU_*_20	YON_*_20
 Arrow	4	OOU0004	—
	6	OOU0006	OON0006
	8	OOU0008	OON0008
	10	OOU0010	OON0010
	12	OOU0012	OON0012
	16	OOU0016	OON0016
	20	OOU0020	OON0020

Outer Inserts Features

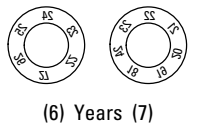
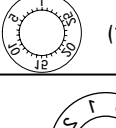
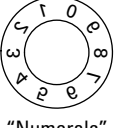
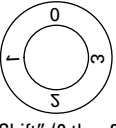
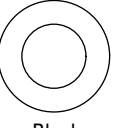
DESCRIPTION	Ø D (mm)	ITEM NUMBER INDEXABLE	ITEM NUMBER FRONT REMOVABLE
 Month (1 thru 12)	4	UUM0004	—
	6	UUM0006	OOM0006
	8	UUM0008	OOM0008
	10	UUM0010	OOM0010
	12	UUM0012	OOM0012
	16	UUM0016	OOM0016
	20	UUM0020	OOM0020
Indexable Front Removable  (6) Years (7)	4	UUY_*_04	—
	6	UUY_*_06	OY_*_06
	8	UUY_*_08	OY_*_08
	10	UUY_*_10	OY_*_10
	12	UUY_*_12	OY_*_12
	16	UUY_*_16	OY_*_16
	20	UUY_*_20	OY_*_20
 Day (1 thru 31)	12	—	OOD0012
	16	UUD0016	OOD0016
	20	UUD0020	OOD0020
 "Numerals" (0 thru 9)	4	UUR0004	—
	6	UUR0006	OOR0006
	8	UUR0008	OOR0008
	10	UUR0010	OOR0010
	12	UUR0012	OOR0012
	16	UUR0016	OOR0016
	20	UUR0020	OOR0020
 "Shift" (0 thru 3)	4	UUS0004	—
	6	UUS0006	OOS0006
	8	UUS0008	OOS0008
	10	UUS0010	OOS0010
	12	UUS0012	OOS0012
	16	UUS0016	OOS0016
	20	UUS0020	OOS0020
 Blank	4	UUB0004	—
	6	UUB0006	OOB0006
	8	UUB0008	OOB0008
	10	UUB0010	OOB0010
	12	UUB0012	OOB0012
	16	UUB0016	OOB0016
	20	UUB0020	OOB0020

NOTES:

- When ordering date-sensitive assemblies, add digits of engraved year requested where asterisks (*) are shown in item number (e.g., UUY1816).
- Availability of year-sensitive items will vary during last quarter of each calendar year. Order next year's Mold Date Inserts during October to beat the rush.

RESIN IDENTIFIERS

Features & Benefits

- Solid triangle Resin Identifiers
- Designed to conform with ASTM International Designation D7611/D7611M-13
- Maximum operating temperature is 150°C (300°F)
- Easily interchangeable

Installation

- Press fit installation required
- Maintain a close tolerance fit
- Utilize cap screw to secure in place
- Accurately measure insert "B"
- Provide "B" pocket to be flush

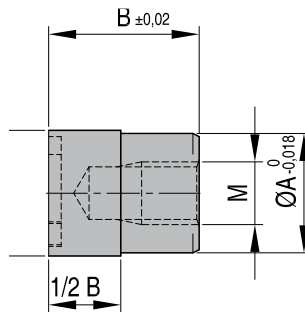

Material: Stainless Steel
Hardness: 48-52 HRC
Max. Temp: 150°C (300°F)

Application

The NEW Standard

The NEW standard designation, the ASTM solid triangles are available online for DME customers.



Identifying Resin

Quickly identify your resin with a resin quality mark.



Safer & Greener

Adding resin marks increases safety and promotes consumer knowledge of the products properties.

RESIN	A	B	M	ITEM NUMBER	RESIN IDENTIFICATION CODE - OPTION A	ITEM NUMBER	RESIN IDENTIFICATION CODE - OPTION B
POLY (ETHYLENE TEREPHTHALATE)	10	12	5	RIC0101A		RIC0101B	
	16	14	6	RIC0201A		RIC0201B	
	20	16	6	RIC0301A		RIC0301B	
HIGH DENSITY POLYETHYLENE	10	12	5	RIC0102A		RIC0102B	
	16	14	6	RIC0202A		RIC0202B	
	20	16	6	RIC0302A		RIC0302B	
POLY (VINYL CHLORIDE)	10	12	5	RIC0103A		RIC0103B	
	16	14	6	RIC0203A		RIC0203B	
	20	16	6	RIC0303A		RIC0303B	
LOW DENSITY POLYETHYLENE	10	12	5	RIC0104A		RIC0104B	
	16	14	6	RIC0204A		RIC0204B	
	20	16	6	RIC0304A		RIC0304B	
POLYPROPYLENE	10	12	5	RIC0105A		RIC0105B	
	16	14	6	RIC0205A		RIC0205B	
	20	16	6	RIC0305A		RIC0305B	
POLYSTYRENE	10	12	5	RIC0106A		RIC0106B	
	16	14	6	RIC0206A		RIC0206B	
	20	16	6	RIC0306A		RIC0306B	
OTHER RESINS	10	12	5	RIC0107A		RIC0107B	
	16	14	6	RIC0207A		RIC0207B	
	20	16	6	RIC0307A		RIC0307B	

FOOD AND CONTAINER IDENTIFIERS

Features & Benefits

- Save on outsourcing and engraving costs
- Easily installed and interchangeable
- In stock, for immediate shipment
- Specials quoted upon request

Installation

- Press fit installation required
- Maintain a close tolerance fit
- Utilize cap screw to secure in place
- Accurately measure insert "B"
- Provide "B" pocket to be flush

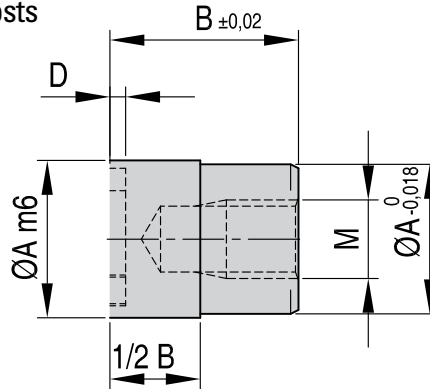

Material: Stainless Steel
Hardness: 48-52 HRC
Max. Temp: 150°C (300°F)



	REF	A	B	D	M	Identification
	MRI1010	10	12	0.3	M5	Food Safe
	MRI1016	16	14		M6	
	MRI1020	20	16		M6	
	MRI1210	10	12	0.3	M5	Top Rack Dishwasher
	MRI1216	16	14		M6	
	MRI1220	20	16		M6	
	MRI1310	10	12	0.3	M5	Dishwasher Safe
	MRI1316	16	14		M6	
	MRI1320	20	16		M6	
	MRI1410	10	12	0.3	M5	Microwave Safe
	MRI1416	16	14		M6	
	MRI1420	20	16		M6	
	MRI1510	10	12	0.3	M5	Freezer Safe
	MRI1516	16	14		M6	
	MRI1520	20	16		M6	

Application

Pack Me

DME's Consumer Identification Marks for packaging, provide customers & consumers with safe and easy to read consumer friendly marks.



RECYCLING INSERTS

Features & Benefits

- Recycle triangle & resin ID
- Saves outsourcing and engraving costs
- Easily installed
- Interchangeable
- Complies with SPI standards

Material: Stainless Steel
Hardness: 48-52 HRC
Max. Temp: 150°C (300°F)

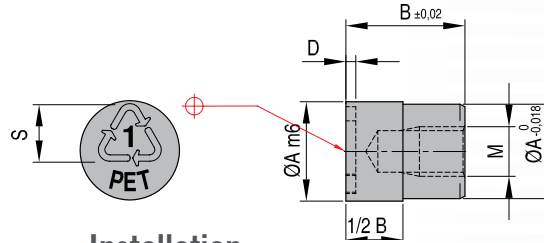

Installation

- Press fit installation required
- Maintain a close tolerance fit
- Utilize cap screw to secure in place
- Accurately measure insert "B"
- Provide "B" pocket to be flush

Application

Keeping It Green

Easy to install and interchangeable, the recycling inserts cover the global range of recyclable marks.



Recycling

Identify your resin and promote recycling by adding DME recycling inserts for consumers to easily identify and separate.



More & More

Don't see the recycle mark insert you need? Give us a call and DME will track it down and get it for you.

Recycling Inserts (METRIC) – MRI

	REF	A	B	D	M	S	Identification	
	MRI0100	10	12	0.3	M5	6	Arrows Only	
	MRI0200	16	14		M6	10		
	MRI0300	20	16		M6	12		
	MRI1101 not hardened	10	12	0.3	M5	6	Blank	
	MRI2202 not hardened	16	14		M6	10		
	MRI3303 not hardened	20	16		M6	12		
	MRI0101GE	10	12	0.3	M5	6	Polyethylene Terephthalate	PET
	MRI0201GE	16	14		M6	10		
	MRI0301GE	20	16		M6	12		
	MRI0101	10	12	0.3	M5	6	Polyethylene Terephthalate	PETE
	MRI0201	16	14		M6	10		
	MRI0301	20	16		M6	12		
	MRI0102	10	12	0.3	M5	6	High Density Polyethylene	HDPE
	MRI0202	16	14		M6	10		
	MRI0302	20	16		M6	12		
	MRI0102GE	10	12	0.3	M5	6	High Density Polyethylene	PE-HD
	MRI0202GE	16	14		M6	10		
	MRI0302GE	20	16		M6	12		
	MRI0103GE	10	12	0.3	M5	6	Polyvinyl Chloride	PVC
	MRI0203GE	16	14		M6	10		
	MRI0303GE	20	16		M6	12		
	MRI0103	10	12	0.3	M5	6	Vinyl	V
	MRI0203	16	14		M6	10		
	MRI0303	20	16		M6	12		
	MRI0104	10	12	0.3	M5	6	Low Density Polyethylene	LDPE
	MRI0204	16	14		M6	10		
	MRI0304	20	16		M6	12		
	MRI0104GE	10	12	0.3	M5	6	Low Density Polyethylene	PE-LD
	MRI0204GE	16	14		M6	10		
	MRI0304GE	20	16		M6	12		
	MRI0104FR	10	12	0.3	M5	6	Low Density Polyethylene	PE-BD
	MRI0204FR	16	14		M6	10		
	MRI0304FR	20	16		M6	12		
	MRI0105	10	12	0.3	M5	6	Polypropylene	PP
	MRI0205	16	14		M6	10		
	MRI0305	20	16		M6	12		
	MRI0106	10	12	0.3	M5	6	Polystyrene	PS
	MRI0206	16	14		M6	10		
	MRI0306	20	16		M6	12		
	MRI0107	10	12	0.3	M5	6	All Other Resins	Other
	MRI0207	16	14		M6	10		
	MRI0307	20	16		M6	12		
	MRI0107GE	10	12	0.3	M5	6	All Other Resins	0
	MRI0207GE	16	14		M6	10		
	MRI0307GE	20	16		M6	12		

RECYCLING ELECTRODES

Features & Benefits

- EDM (Electric Discharge Machining) pre-made electrodes save on outsourcing and engraving.
- No drilling required for installation & inserts
- Complies with SPI standards
- Material - Electrolytic Copper E-Cu

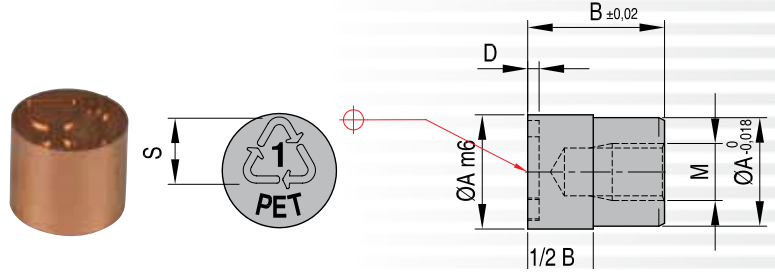

Recycling Electrodes (METRIC) – MRE

	REF	A	B	D	M	S	Identification	
	MRE0100	10	12	0.3	M5	6	Arrows Only	
	MRE0200	16	14		M6	10		
	MRE0300	20	16		M6	12		
	MRE1101 not hardened	10	12	0.3	M5	6	Blank	
	MRE2202 not hardened	16	14		M6	10		
	MRE3303 not hardened	20	16		M6	12		
	MRE0101GE	10	12	0.3	M5	6	Polyethylene Terephthalate	PET
	MRE0201GE	16	14		M6	10		
	MRE0301GE	20	16		M6	12		
	MRE0101	10	12	0.3	M5	6	Polyethylene Terephthalate	PETE
	MRE0201	16	14		M6	10		
	MRE0301	20	16		M6	12		
	MRE0102	10	12	0.3	M5	6	High Density Polyethylene	HDPE
	MRE0202	16	14		M6	10		
	MRE0302	20	16		M6	12		
	MRE0102GE	10	12	0.3	M5	6	High Density Polyethylene	PE-HD
	MRE0202GE	16	14		M6	10		
	MRE0302GE	20	16		M6	12		
	MRE0103GE	10	12	0.3	M5	6	Polyvinyl Chloride	PVC
	MRE0203GE	16	14		M6	10		
	MRE0303GE	20	16		M6	12		
	MRE0103	10	12	0.3	M5	6	Vinyl	V
	MRE0203	16	14		M6	10		
	MRE0303	20	16		M6	12		
	MRE0104	10	12	0.3	M5	6	Low Density Polyethylene	LDPE
	MRE0204	16	14		M6	10		
	MRE0304	20	16		M6	12		
	MRE0104GE	10	12	0.3	M5	6	Low Density Polyethylene	PE-LD
	MRE0204GE	16	14		M6	10		
	MRE0304GE	20	16		M6	12		
	MRE0104FR	10	12	0.3	M5	6	Low density Polyethylene	PE-BD
	MRE0204FR	16	14		M6	10		
	MRE0304FR	20	16		M6	12		
	MRE0105	10	12	0.3	M5	6	Polypropylene	PP
	MRE0205	16	14		M6	10		
	MRE0305	20	16		M6	12		
	MRE0106	10	12	0.3	M5	6	Polystyrene	PS
	MRE0206	16	14		M6	10		
	MRE0306	20	16		M6	12		
	MRE0107	10	12	0.3	M5	6	All Other Resins	Other
	MRE0207	16	14		M6	10		
	MRE0307	20	16		M6	12		
	MRE0107GE	10	12	0.3	M5	6	All Other Resins	0
	MRE0207GE	16	14		M6	10		
	MRE0307GE	20	16		M6	12		

NOTE: Additional material codes are available. Contact DME for quote.

Application

Burning the Mark

When you need to etch your tool and ID the recycle resin DME electrodes are ready for you.



Savings & Safety

Use DME electrodes to eliminate outsourcing and engraving machining costs and help identify resins for recycling.

DME EZ-ADAPTER

DME EZ-Adapter

EZ-Adapter insert spacers from DME allow you to change from longer style inserts to a standard DME insert quickly and easily. Remove your old insert, install the adapter into the pocket, and then install your DME standard insert. The spacer is made to exact specifications to ensure flush height.



ITEM NUMBER	Ø D (MM)	L
DSF0404	4	4
DSF0612	6	12
DSF0810	8	10
DSF1008	10	8
DSF1206	12	6
DSF1606	16	6
DSF2004	20	4

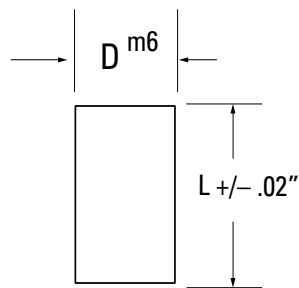

Material: Stainless Steel
 Hardness: 50-55 HRC
 Max. Temp: 150°C (300°F)

Application

Change is Easy

It's easy to change over to DME standard mold mark inserts with our NEW standard depth spacers. Adapt your existing non-DME standard cavity to work with our many industry leading offerings.



Other Brand

DME Insert

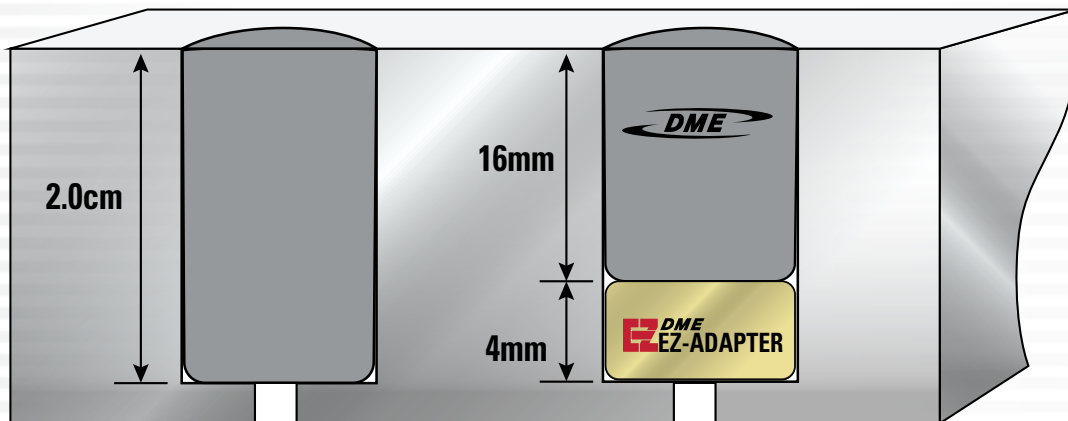

Mold Base Plate

Always Available 24/7 at store.DME.net

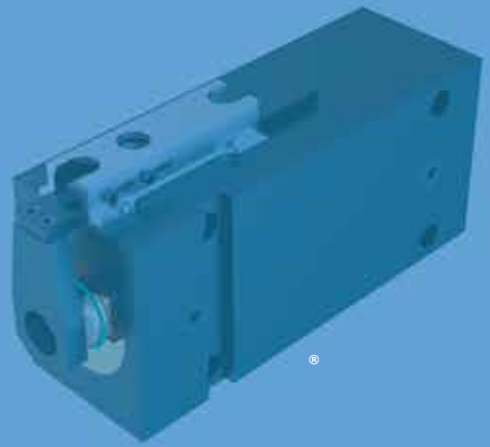

A company is more than the sum of it's parts. Like every product created in the molding industry it is the combination of the best materials, machines, processes and the people who work tirelessly to achieve the highest standard of quality. With DME you get all of this, a one-stop-shop of product , time earned knowledge, cutting edge technology and mold industry experts.

We're always with you, "*every step of the way.*"

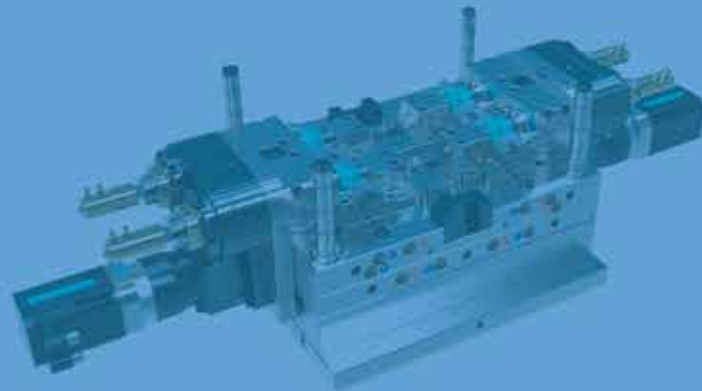
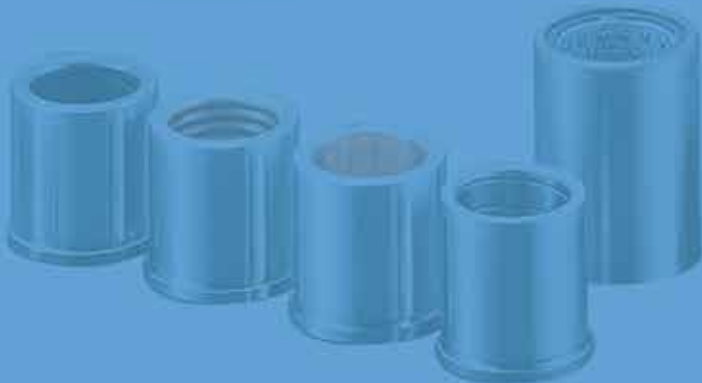

eSTORE
 store.dme.net

Your One-Stop-Shop!

With tens of thousands of products to choose from, DME is your one-stop shop for everything molding. From complex undercuts solutions and plate control to standard pins, bushings and interlocks, the DME line of mold components will help you build or rebuild your mold base inside out, top to bottom. Industrial Supplies, Mold Bases, MUD Quick-Change, Control Systems, and Hot Runner solutions round out our extensive offering to truly be your one-stop shop.



World Headquarters

DME Company LLC

29111 Stephenson Highway
Madison Heights, MI 48071

800-626-6653 toll-free tel

248-398-6000 tel

www.dme.net web

dme@dme.net e-mail

DME of Canada Ltd.

5345 Outer Drive Unit# 3

Oldcastle, Ontario

Canada N9G 0C3

800-387-6600 toll-free tel

905-677-6370 tel

dme_canada@dme.net e-mail

DME Mexico / South America

Circuito el Marques Notre, No.55

Parque Industrial El Marqués

El Marqués, Querétaro, CP 76246

52.442.713.5666 tel

dme_mexico@dme.net

