

Temperature & Voltage Controls



Section F Contents

A		Jacks, Plugs and Fuse Holders555	Rigid Probe553	
Adaptors		M		
Bayonet.....554		Multimeters	Ring Mount.....553	
Metric-to-English554		1000A Clamp Meter572	Shallow Nozzle.....543	
Air Guns		Digital - Autoranging571	Spade Type549	
Cold Air Gun459		P		
Super Air Wipes..... 460-461		Power Controls	Standard543	
B		SCR.....514	Thermocouple Extensions552	
Butt Connector562		Pressure Indicators	Thermometers	
C		Melt Pressure Gages - Flexible.519	Digital Pocket.....538	
Cable Ties		Melt Pressure Gages - Rigid Stem .	Dial539	
Bases.....561		518	Non-Contact	
Nylon.....561		Q		
Contactors		Quick Disconnects, Wire.....554	U	
30 Amp Quantum IM Mounts...569		S		
Mercury.....567		Sound Level Meters570	UATC20 Temp. Controllers..... 520-527	
Connectors		Static	V	
Temperature Control - Epic 536-537		Digital Static Charge Meter459	Voltage Sensors.....568	
Mold Connectors529		Staticide Liquid458	W	
Temp Control528		Static Charge Measuring Device....458	Wire	
Wire.....563		T		Crimp/Cut/Strip Tools.....559
Cartridge Heater Lubricant/Thermal		Tape		Fiberglass Sleeving.....560
Conduction509		Economy Glass Tape.....564	Heater Wire.....557	
Cast Heaters.....513		PVC Electrical Tape.....564	Sheathed Cables558	
Coil Heaters - Mini.....497		Temperature Controls		Silicone Sleeving558
Custom Heat Strips491		Standard Mainframe Config.526		Stainless Steel Armor.....556
Current Ring Indicators569		1-2 Zones Mainframes		Thermocouple Wire556
H		Accessories.....528		Wire Connectors
Heater Bands		5-12 Cables & Connectors...529		Ceramic.....563
Ceramic Expandable..... 485-487		Blank Panels/Stand.....528		3M Super563
Custom Mica Heater Bands484		Connectors - Epic537		
Heat Transfer Compound463		Mainframes.....525		
Metric.....463		Modules 520-527		
Mica Insulated462		1 Zone Control.....522; 531-532		
Mica w/Flange Lock.....474-476		Temp. Control Modules 520-527		
Mineral Insulated 488-489		Terminal Mount Boxes..530; 534		
Nozzle Bands..... 464-465		Terminal Covers Ceramic.....564		
OEM Replacement Parts		Terminal Lugs562		
Cincinnati Milacron 479-480		Thermocouple Selection.....542		
Van Dorn481-483		Thermocouple		
Standard Mica 466-472		Adjustable Depth547		
Replacement Heater Straps..473		Adj Depth-Armor Covered548		
Wedge-Lock.....477-478		Adjustable Depth-RTD549		
Heaters		Bendable Probe.....551		
Cartridge Heaters		Hi-Temp..... 544-546		
Standard 499-502		Miniature545		
High Watt Density503		Miniature Molded546		
Lead Options510		Mini Sleeve Molded Transition.546		
Premium 506-508		Lug Mounted550		
With Thermocouples 511		Melt Bolt551		
Drum Heaters.....512		Newbury (Type J).....552		
Flexible Tubular Heaters 493-496		Pipe Clamp550		
Immersion Heaters492				
Sleeve Heaters - Kappa.....498				
Silicone Rubber Heaters492				
J				



Staticide™

General Purpose Staticide® Outperforms! For Non-Porous Surfaces

Staticide is non-toxic, nonflammable, non-staining, completely biodegradable and safe to use. It's the key component in any total environmental static control program.

When properly applied, Staticide complies with or exceeds all electrostatic decay criteria established for antistatic performance as set forth by NFPA and MIL B-81705B, when tested in accordance with Federal Test Standard 101B Method 4046.

Solves static-related problems such as:

- The attraction of dirt, dust and bacteria to all environmental surfaces, products and product packaging
 - Charge generation on surfaces of tote boxes and carriers used to process and store electronic components
 - Damage or destruction of sensitive electronic components and subassemblies during their manufacture, shipping or receiving
 - Data processing "glitches"... memory loss, data errors, paper jams
- General Purpose Staticide is packaged in ready-to-use quart bottles with trigger sprayers or in easy-to-pour gallon containers.

Please call DME for available in bulk quantities.



General Purpose Staticide Quarts w/ Sprayer
Part Number
ACL2003
General Purpose Staticide Gallons
Part Number
ACL2001

STATICIDE

Static Charge Measuring Device

Measures Static Charge Instantly, Reliably and Economically!

- Measures static charges from zero to 30,000 volts
- Convenient pocket size
- Designed for close-in repetitive readings
- Uses standard 9 volt battery
- Battery test feature
- Low drift
- Repeatability ± 1%, accuracy ± 10%
- One-year warranty on parts and labor

Features a unique "quick zero" function which instantly zeroes the instrument and provides ground compensation for the user. Size: 4-3/8" x 2-5/8" x 1-5/16"



Static Charge Measuring Device - Part Number ACL300B
Protective Carrying Case - Part Number ACLCS13

STATIC CHARGE MEASURING DEVICE

Digital Static Charge Meter



ESD Digital Static Meter

Industrial Digital Electrostatic Meter

Accurate, sensitive and responsive, the Model 7905 Digital Static Charge Meter allows easy one-hand static measurements. It indicates the surface voltage and polarity on objects up to ± 20 kV at a spacing of one inch (25mm). The Digital Static Meter features a push button "hold" for readings and automatic "power off."

Designed for use by industrial, maintenance, electrical and other field personnel, the 7905 has a rugged, hard shell plastic case and a compact design. With low drift and trouble-free operation, maintenance consists of periodic replacement of its 9 volt battery.

The 7905's digital readout instantly indicates the magnitude and polarity of any static charge. It's easy to locate and monitor potential trouble spots, position static elimination equipment, and evaluate the effectiveness of existing systems.

Part Number #7905 (unit includes rugged hard shell carrying case and battery)

Specifications

Range: 0 to ± 20 kV at 1"

Power: (1) 9 volt battery (Eveready 216)

Distance: The meter reads true at 1" from thick the test surface

Size: 4.14" (10.6cm) long, 2.4" (6.1cm) wide, 1" (2.5cm)

Color: black

Accuracy: $\pm 10\%$ of full scale (113 grams)

Weight: Approximately $\frac{1}{4}$ pound



DIGITAL STATIC CHARGE METER

Cold Air Gun

F

Replace messy mist systems - improve dry machining with clean, cold air! Clean, cold air at 50°F below supply air temperature, with no moving parts!

Features

- Low cost
- Compact
- No moving parts
- Maintenance-free
- Quiet
- Magnetic base

Use For

- Cooling parts
- Cooling core pins
- Setting hot melts
- Minimize heat sinks
- Stop drooling or freeze-off a nozzle

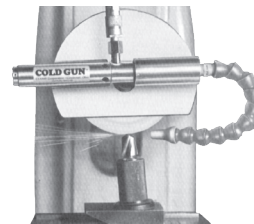

COLD AIR GUN

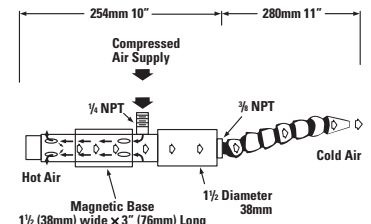

How the Cold Gun Works:

The Cold Gun Air Coolant System incorporates a vortex tube to convert an ordinary supply of compressed air into two low pressure streams: one hot and one cold. The hot air stream is muffled and discharged through the hot air exhaust. The cold air is muffled and discharged through the flexible hose, which directs it to the point of use. The magnetic base provide easy mounting and portability.

Ordering Information

Cold Gun Kits include: Cold Gun with magnetic base, pneumatic filter with manual drain, single or double point flexible hose kit.

[CG5215](#)

Single Point Cold Gun Kit

U.S. 800-626-6653 • Canada 800-387-6600 • Mexico 52-442-7135666 • Worldwide 248-398-6000

[dme.net](#) • [store.dme.net](#)



Super Air Wipes

Blow off, dry, clean and cool pipe, cable, extruded shapes and hose!

Split design requires no threading!

EXAIR's Super Air Wipe provides a uniform 360° airstream that is ideal for blowoff, drying, cleaning and cooling of pipe, cable, extruded shapes, hose and more. The split design offers easy clamping around the surface of the material moving through it, eliminating the need for threading. All models include stainless steel screws and shims. Stainless steel wire braided hose is also included on sizes up to 4" (102mm) for added corrosion and heat resistance. Aluminum models are rated for temperatures up to 400°F (204°C) and stainless steel models for temperatures up to 800°F (427°C).

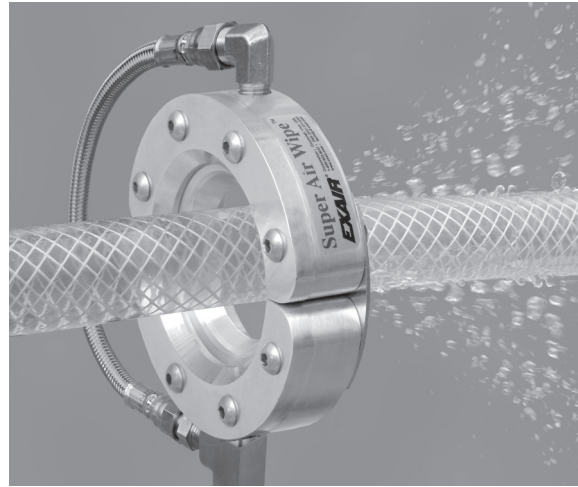

SUPER AIR WIPES

Air Wipe Performance			
80 PSIG (5.5 BAR)	Air Consumption		Sound Level @ 3' (.91m)
Model	SCFM	SLPM	dBA
2401, 2401SS	19.1	541	76
2402, 2402SS	29.5	835	77
2403, 2403SS	39.8	1127	79
2404, 2404SS	50.2	1422	81
2405	60.6	1716	82
2406	71.0	2010	84
2407	81.3	2302	85
2409	102.1	2891	87
2411	122.8	3477	89

Advantages

- Quiet
- Low air consumption
- Uniform airflow across the entire diameter
- Stainless steel hardware resists corrosion
- Aluminum models for temperatures up to 400°F (204°C); stainless steel models for temperatures to 800°F (427°C)
- Stainless steel hose supplied on sizes up to 4" (102mm)
- No electricity, no moving parts
- Non-contact - no wiper blade
- Split design - compact, rugged, easy to install
- Lightweight, low profile
- Tapped holes for mounting
- Variable force and flow
- Meets OSHA maximum dead-end pressure and noise requirements

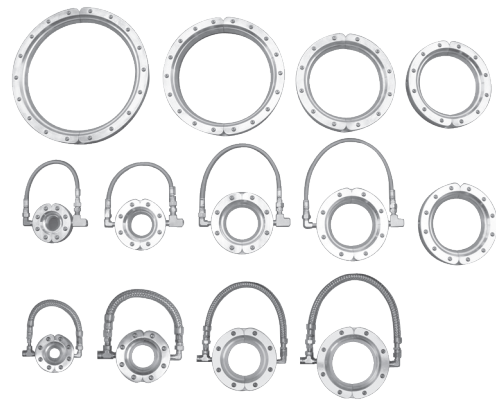

The Aluminum Super Air Wipe is available in 9 sizes from stock. The Stainless Steel Super Air Wipe is available in 4 sizes from stock. Other sizes are available by special order.

Applications

- Drying after wash, cleaning, plating or coating
- Blow off dust and contaminants
- Cool hot extruded shapes
- Uniformly wipe surfaces
- Eliminate solution carryover - no cross contamination
- Remove excess coatings, water and oil
- Minimize solution loss due to drag-out
- Dry screen printed and ink jet surfaces
- Ideal for pipe, cable, extrusions, wire, rod and hose

SUPER AIR WIPES

How The Air Wipe Works

Compressed air flows through an inlet (1) of the Air Wipe into an annular chamber (2). It is then throttled through a small ring nozzle (3) at high velocity. This primary airstream adheres to the Coanda effect (4), which directs it down the angled surface of the Air Wipe. A low pressure area is created at the center (5) inducing a high volume flow of surrounding air into the primary airstream. As the airflow leaves the Air Wipe, it creates a conical 360° ring of air that attaches itself to the surface of the material running through it (6), uniformly wiping the entire surface with the high velocity airflow.

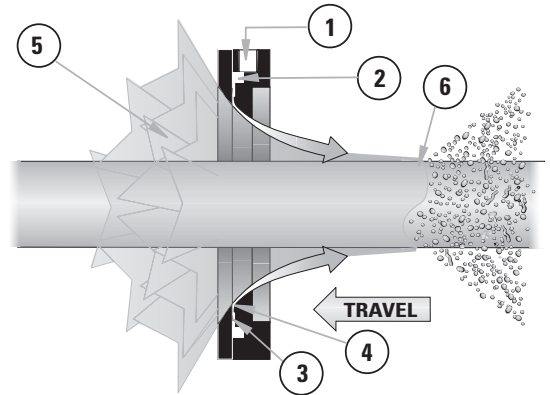

Super Air Wipe Systems

Super Air Wipe	
Model Number	Description
2401	1" (25mm)
2402	2" (51mm)
2403	3" (76mm)
2404	4" (102mm)
2405	5" (127mm)
2406	6" (152mm)
2407	7" (178mm)
2409	9" (229mm)
2411	11" (279mm)

Super Air Wipe Kit	
<i>Kit includes Super Air Wipe, filter separator, pressure regulator and shim set</i>	
Model Number	Description
2451	1" (25mm)
2452	2" (51mm)
2453	3" (76mm)
2454	4" (102mm)
2455	5" (127mm)
2456	6" (152mm)
2457	7" (178mm)
2459	9" (229mm)
2461	11" (279mm)

Super Air Wipe Is Easy To Use

There is a 1/4" NPT female inlet on each half of the Super Air Wipe on sizes up to 7" (178mm). Larger sizes include two 1/4" NPT female inlets on each half in order to maintain proper air volume and performance. Aluminum Super Air Wipes up to 4" (102mm) include a brass tee that supplies one half directly and a stainless steel wire braided coupling hose rated at 400°F (204°C) to supply the other half. Stainless steel Super Air Wipes up to 4" (102mm) include a stainless steel tee and a stainless steel wire braided coupling hose rated at 800°F (427°C). Larger sizes should be piped directly.

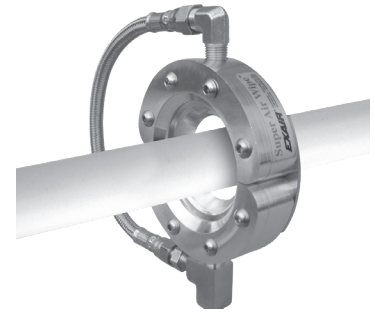

The Model 2402 2" (51mm) Super Air Wipe cools PVC pipe as it is ejected from an extruder.

Stainless Steel Super Air Wipe	
Model Number	Description
2401SS	1" (25mm)
2402SS	2" (51mm)
2403SS	3" (76mm)
2404SS	4" (102mm)

Stainless Steel Super Air Wipe Kit	
<i>Kit includes Super Air Wipe, filter separator, pressure regulator and shim set</i>	
Model Number	Description
2451SS	1" (25mm)
2452SS	2" (51mm)
2453SS	3" (76mm)
2454SS	4" (102mm)

Super Air Wipe Shim Set	
<i>Shim Sets include (2) .002" (.05mm) thick stainless steel shim</i>	
Model Number	Description
2351SS	1" (25mm)
2352SS	2" (51mm)
2353SS	3" (76mm)
2354SS	4" (102mm)
2355SS	5" (127mm)
2356SS	6" (152mm)
2357SS	7" (178mm)
2359SS	9" (229mm)
2361SS	11" (279mm)



Mica Insulated Heater Band

Time-tested materials & manufacturing techniques make this heater a proven, economical, reliable performer. In applications where a flat surface requires uniform heating, this heater has no equal.

Material List

- 1) Stainless steel post terminals are supplied with nuts and washers. Connections are attached to the oversized terminal head for superior electrical contact. Many other terminations and leads available.
- 2) Stainless steel welded on clamps have precision drilled and tapped barrel nuts and are supplied with high torque 10–32 socket head cap screws. These are used for firm clamping and excellent heat transfer.
- 3) The two-piece sheath is composed of a rust-resistant, matte finish, zinc-coated bottom plate and galvanized top plate. This construction provides excellent heat emissivity and corrosion resistance.
- 4) Mica provides complete electrical insulation of the heater case from the steel case, while providing maximum heat transfer.
- 5) Flat nickel-alloy ribbon wire provides the highest heating area possible. Each heater is engineered for wire size and pitch to provide the highest efficiency, while minimizing winding temperature.

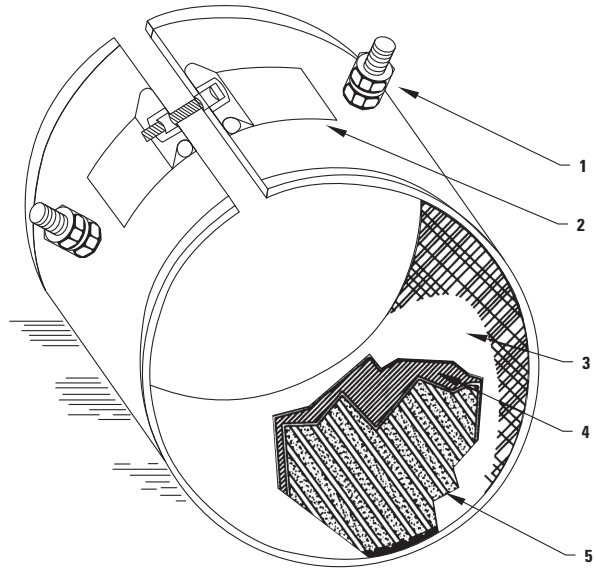

MICA HEATER BAND

Maximum Recommended Watts

When heating objects to higher temperatures, lower watt density heater bands should be used. This will help to prevent overheating and provide a longer heater band life.

Watt density is the total wattage of the heater band divided by the heated surface area of the heater band. Use this table below to help determine the recommended watt density for the application. Lower watt densities can be achieved by operating a 240 volt heater band on 120 volts. In doing this the wattage and watt density are derated by a factor of 4.

- One piece and 2-piece bands
- Fiberglass leads, stainless leads and post terminals
- 120 and 240 volt styles
- Uniform heat, high watt density
- Many wattage options
- High-quality sheet mica construction
- Many sizes in stock ready to ship
- Custom bands available in rush and standard delivery option

Operating Temp.	Maximum Recommended Watts Per Sq. In.
300°F (149°C)	40
400°F (204°C)	30
500°F (260°C)	21
600°F (316°C)	12
700°F (371°C)	10
800°F (427°C)	10
900°F (482°C)	10

Metric Heater Bands



- Low cost, quality bands
- For other sizes, please see Standard Mica Heater Band pages that follow
- 12" stainless steel leads

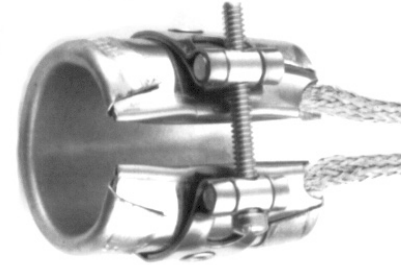

METRIC HEATER BAND

Metric (mm)		U.S. (in)		Volts	Watts	Part Number
Dia.	Width	Dia.	Width			
25	25	.984	.984	240	85	MHB2525-85
25	35	.984	1.378	240	125	MHB2535-125
30	30	1.181	1.181	240	135	MHB3030-135
30	38	1.181	1.496	240	185	MHB3038-185
32	25	1.260	.984	240	115	MHB3225-115
32	30	1.260	1.181	240	145	MHB3230-145
32	38	1.260	1.496	240	195	MHB3238-195
32	50	1.260	1.969	240	250	MHB3250-250
35	20	1.378	.787	240	95	MHB3520-95
35	25	1.378	.984	240	125	MHB3525-125
35	30	1.378	1.181	240	155	MHB3530-155
35	35	1.378	1.378	240	180	MHB3535-180
35	38	1.378	1.496	240	210	MHB3538-210
35	50	1.378	1.969	240	265	MHB3550-265
38	30	1.496	1.181	240	170	MHB3830-170
38	35	1.496	1.378	240	200	MHB3835-200
38	50	1.496	1.969	240	300	MHB3850-300
40	25	1.575	.984	240	160	MHB4025-160
40	30	1.575	1.181	240	200	MHB4030-200
40	38	1.575	1.496	240	270	MHB4038-270
40	50	1.575	1.969	240	345	MHB4050-345



Heat Transfer Compound

HEAT TRANSFER COMPOUND



- Transfers heat away from electronic devices
- High thermal conductivity
- Temperature range to 400°F

Highly effective when used with rectifiers, ignition control modules, voltage regulators and other heat generating electronic devices.

Part Number 49643 - 5 oz. tube



Nozzle Bands

- Low cost, quality bands
- For other sizes, please see Standard Mica Heater Band pages that follow

Inside Diameter	Width	Volts	Watts	Part Number	Reference Number	Lead Type*
1" Diameter	1"	120	100	HB1-101012-100	BN1010A1	FG
	1"	240	100	HB1-101024-100	BN1010A2	FG
	1"	120	125	HB1-101012-125S	–	SS
	1"	240	125	HB1-101024-125S	–	SS
	1"	120	125	HB1-101012-125	–	FG
	1"	240	125	HB1-101024-125	–	FG
	1½"	120	150	HB1-101512-150	–	FG
	1½"	240	150	HB1-101524-150	BN1015A2	FG
	2"	120	200	HB1-102012-200	BN1020A1	FG
	2"	240	200	HB1-102024-200	BN1020A2	FG
	3"	120	300	HB1-103012-300	BN1030A1	FG
	3"	240	300	HB1-103024-300	BN1030A2	FG
1½" Diameter	1"	120	150	HB1-151012-150	BN1510A1	FG
	1"	240	150	HB1-151024-150	BN1510A2	FG
	1½"	120	275	HB1-151512-275	–	FG
	1½"	240	275	HB1-151524-275	–	FG
	1½"	120	275	HB1-151512-275S	–	SS
	1½"	240	275	HB1-151524-275S	–	SS
	2"	120	300	HB1-152012-300	BN1520A1	FG
	2"	240	300	HB1-152024-300	BN1520A2	FG
	2"	120	300	HB1-152012-300S	BN1520B1	SS
	2"	240	300	HB1-152024-300S	BN1520B2	SS
	3"	120	450	HB1-153012-450	BN1530A1	FG
	3"	240	450	HB1-153024-450	BN1530A2	FG
	4"	120	550	HB1-154012-550	–	FG
	4"	240	550	HB1-154024-550	–	FG
	5"	120	700	HB1-155012-700	–	FG
	5"	240	700	HB1-155024-700	–	FG
1¾" Dia.	1½"	120	250	HB1-1751512-250	BN1715A1	FG
	1½"	240	250	HB1-1751524-250	BN1715A2	FG
2" Dia.	1"	120	200	HB1-201012-200	BN2010A1	FG
	1"	240	200	HB1-201024-200	BN2010A2	FG



NOZZLE BANDS

***12" lead lengths standard**

FG = fiberglass

SS = stainless steel

**All Nozzle Bands Include
12" Stainless Steel Braided Leads!!!**

Inside Diameter	Width	Watts	Volts	Part Number
3/4"	1"	100	240	B029586
	1 1/2"	150	240	B016886
	1 1/2"	200	240	B028956
	2"	200	240	B020010
	2"	150	120	B031793
	3"	300	240	B029537
1 1/4"	1"	150	240	B028271
	1 1/2"	200	240	B028272
	2"	250	240	B029837
1 1/2"	1"	150	240	B017022
	1 1/4"	250	240	B034406
	2"	350	240	B011941
	2"	350	120	B030459
	2"	400	240	B033555
	2 1/2"	300	240	B029521
	4"	500	240	B012933
1 5/8"	1 1/2"	300	240	B034363
1 3/4"	1"	200	240	B013847
	1 1/2"	250	240	B029274
	1 1/2"	300	240	B034459
	2"	300	240	B029541
	2"	300	120	B033605
1 7/8"	3"	450	240	B031023
	2"	350	240	B030666
2"	1"	200	240	B029542
	1 1/2"	325	240	B029050
	1 1/2"	325	120	B018274
	2"	350	240	B030113
	2"	350	120	B030885
	2"	400	240	B035725
2 1/2"	1"	150	240	B037454
	1 1/2"	300	240	B035329
	1 1/2"	420	120	B042475

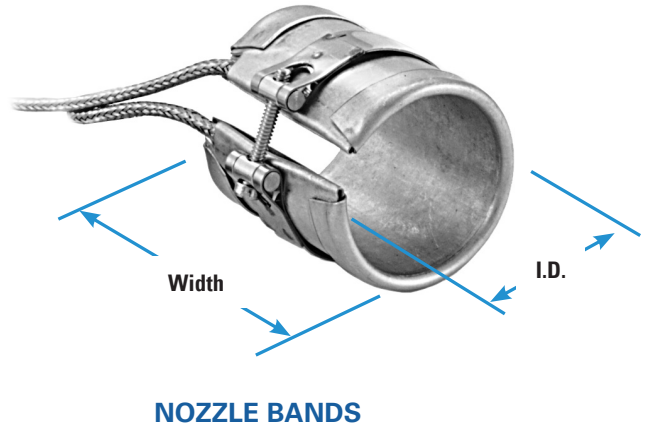



Standard Mica Heater Bands

- High-quality sheet mica construction
- Uniform heat, high watt density
- 10" high temperature leads with protective sleeves are standard

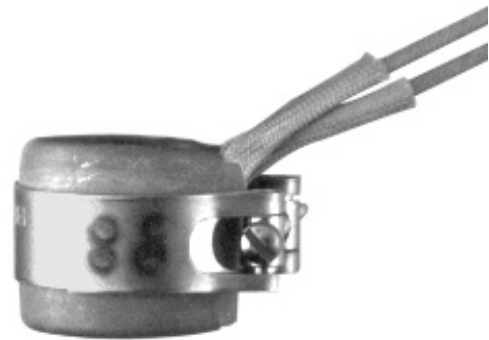

STANDARD MICA HEATER BANDS

I.D. x Width	Volts	Watts	10" Flexible Leads Unless Noted	Part Number
3/4 x 1	120	75		SHB121612-75
	240	75		SHB121624-75
3/4 x 1 1/2	240	100		SHB122424-100
7/8 x 1	120	80		SHB141612-80
	240	80		SHB141624-80
7/8 x 1 1/4	120	90		SHB142012-90
	240	90		SHB142024-90
7/8 x 1 1/2	120	100		SHB142412-100
	240	100		SHB142424-100
1 x 1	120	100		HB1-101012-100
	240	100		HB1-101024-100
	120	100	10" Stainless	SHB161612-100S
	240	100	10" Stainless	SHB161624-100S
	120	125	10" Stainless	HB1-101012-125S
	240	125	10" Stainless	HB1-101024-125S
	120	125		HB1-101012-125
	240	125		HB1-101024-125
1 x 1 1/2	120	150		HB1-101512-150
	240	150		HB1-101524-150
1 x 2	120	200		HB1-102012-200
	240	200		HB1-102024-200
1 x 2 1/2	120	250		SHB164012-250
	240	250		SHB164024-250
	240	250	34" Stainless	SHB164024-250S
1 x 3	120	300		HB1-103012-300
	240	300		HB1-103024-300
1 x 4	120	400		SHB166412-400
	240	400		SHB166424-400
1 x 5	120	500		SHB168012-500
	240	500		SHB168024-500
30mm x 30mm	240	150	12" SS Braid	B041556

Standard Mica Heater Bands



I.D. × Width	Volts	Watts	10" Flexible Leads Unless Noted	Part Number
1¼ × ⅝	120	100	10" Stainless	SHB201012-100S
1¼ × 1	120	125		SHB201612-125
	240	125		SHB201624-125
1¼ × 1½	120	200		SHB202412-200
	240	200		SHB202424-200
1¼ × 1¾	240	275		SHB202824-275
1¼ × 2	120	250		SHB203212-250
	240	250		SHB203224-250
1¼ × 3	120	400		SHB204812-400
	240	400		SHB204824-400
1¼ × 3½	240	300		SHB205624-300
1⅜ × 1	120	150		SHB221612-150
	240	150		SHB221624-150
1⅜ × 1½	120	200		SHB222012-200
	240	200		SHB222024-200
1⅜ × 2	120	275		SHB223212-275
	240	275		SHB223224-275
1⅜ × 3½	240	250		SHB225624-250
1½ × ½	120	100		SHB240812-100
	240	100		SHB240824-100
1½ × ⅝	120	100		SHB241012-100
	240	100		SHB241024-100
1½ × ¾	120	100		SHB241212-100
	240	100		SHB241224-150
1½ × 1	120	150		HB1-151012-150
	240	150		HB1-151024-150
	120/ 240	150		SHB24161224-150
1½ × 1½	230	200		SHB242423-200
	240	200	24" SS Braid	B041830
	240	250	24" Leads	B021993
	240	250		SHB242424-250
	120	275		HB1-151512-275
	240	275		HB1-151524-275
	240	275	24" SS Braid	B017026
	240	275	34" Leads	SHB242424-275-34
	480	275	12" SS Braid	B038203
	120/ 240	275		SHB24241224275
	120	275	34" Leads	SHB242412275-34
	240	275	34" Leads	SHB242424-275-34

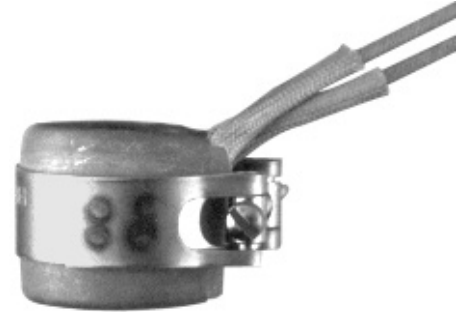

STANDARD MICA HEATER BANDS





Standard Mica Heater Bands

I.D. x Width	Volts	Watts	10" Flexible Leads Unless Noted	Part Number
1½ x 1½	120	275	10" Stainless	HB1-151512-275S
	240	275	10" Stainless	HB1-151524-275S
	120	275	Post	SHB242412-275P
	240	275	Post	SHB242424-275P
	120	275	With TC Hole	SHB242412275TC
	240	275	With TC Hole	SHB242424275TC
	230	275	Type A 54"	50387B
	240	300	10" Stainless	SHB242424-300S
1½ x 1¾	120	285		SHB242812-285
	240	285		SHB242824-285
1½ x 2	120	300		HB1-152012-300
	240	300		HB1-152024-300
	120	300	10" Stainless	HB1-152012-300S
	240	300	10" Stainless	HB1-152024-300S
1½ x 2½	120	400		SHB244012-400
	240	400		SHB244024-400
	240	400	34" Stainless	SHB244024-400S
1½ x 3	120	450	10" Stainless	SHB244812-450S
	240	450	10" Stainless	SHB244824-450S
	120	450		HB1-153012-450
	240	450		HB1-153024-450
	120/ 240	450	12" Stainless	SHB244824-450S
1½ x 3½	120	525		SHB245612-525
	240	525		SHB245624-525
1½ x 4	120	550		HB1-154012-550
	240	550		HB1-154024-550
	120/ 240	550		SHB24641224550
1½ x 5	120	700		HB1-155012-700
	240	700		HB1-155024-700
	240	700	12" SS Braid	B044624
1½ x 6	240	700	24" SS Braid	B027067
	240	850		SHB249624-850
1½ x 7	240	800	24" SS Braid	B027068
1⅝ x 3	240	300	12" SS Braid	B036062
1¾ x 1	120	175		SHB281612-175
	240	175		SHB281624-175

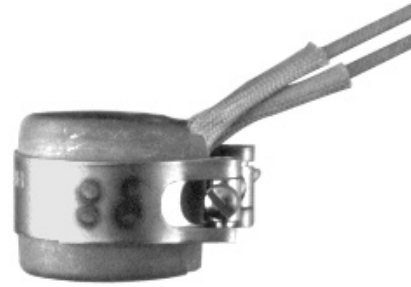

STANDARD MICA HEATER BANDS

Standard Mica Heater Bands



I.D. × Width	Volts	Watts	10" Flexible Leads Unless Noted	Part Number
1¼ × 1½	120	250		HB1-1751512-250
	240	250		HB1-1751524-250
1¼ × 1¾	240	350	24" SS Braid	B038843
1¾ × 2	120	350		SHB283212-350
	240	350		SHB283224-350
1¾ × 2½	120	450		SHB284012-450
	240	450		SHB284024-450
1¾ × 3	120	500		SHB284812-500
	240	500		SHB284824-500
1¾ × 3½	120	500		SHB285612-500
	240	500		SHB285624-500
1¾ × 4	120	700		SHB286412-700
	240	700		SHB286424-700
1¾ × 5	240	900	34" Stainless	SHB288024-750S
	120	900		SHB288012-900
	240	900		SHB288024-900
1¾ × 6	120	1000		SHB289612-1000
	240	1000		SHB289624-1000
1⅞ × 1	120	300	Post	SHB301612-300P
	240	300	Post	SHB301624-300P
2 × 1	120	200		HB1-201012-200
	240	200		HB1-201024-200
2 × 1⅜	240	300		SHB322224-300
2 × 1½	120	300		SHB322412-300
	240	300		SHB322424-300
	120/ 240	300		SHB32241224300
2 × 2	120	400		SHB323212-400
	240	400		SHB323224-400
2 × 2½	120	500		SHB324012-500
	240	500		SHB324024-500
2 × 3	120	600		SHB324812-600
	240	600		SHB324824-600
	240	675	12" SS Braid	B039887
2 × 4	120	800		SHB326412-800
	240	800		SHB326424-800
2 × 5	120	900		SHB328012-900
	240	900		SHB328024-900
2 × 6	120	1200		SHB329612-1200
	240	1200		SHB329624-1200
2⅞ × 1	120	225		SHB341612-225
	240	225		SHB341624-225
2⅞ × 1½	120	300		SHB342412-300
	240	300		SHB342424-300
2⅞ × 2	120	400		SHB343212-400
	240	400		SHB343224-400

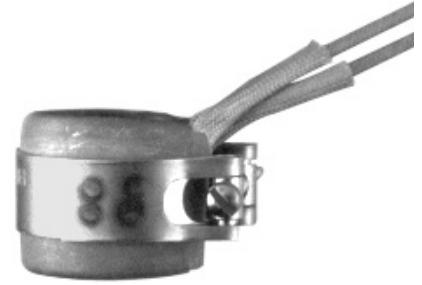

STANDARD MICA HEATER BANDS





Standard Mica Heater Bands

I.D. x Width	Volts	Watts	10" Flexible Leads Unless Noted	Part Number
2 1/8 x 3	120	600		SHB344812-600
	240	600		SHB344824-600
2 1/4 x 1	120	225		SHB361612-225
	240	225		SHB361624-225
2 1/4 x 1 1/2	120	350		SHB362412-350
	240	350		SHB362424-350
	240	500	24" SS Braid	B019091
2 1/4 x 2	120	450		SHB363212-450
	240	450		SHB363224-450
2 1/4 x 2 1/2	240	600	Post	SHB364024-600P
	120	600		SHB364012-600
	240	600		SHB364024-600
2 1/4 x 3	120	700		SHB364812-700
	240	700		SHB364824-700
2 3/8 x 1	120	150		SHB381612-250
	240	250	Post	SHB381624-250
	240	250	Post	36210B*
	460	250	Post	47937B*
2 3/8 x 1 1/2	120	400		SHB382412-400
	240	400		SHB382424-400
2 7/16 x 1	230	250	72" Leads	66270B*
2 1/2 x 1	120	300		SHB401612-300
	240	300		SHB401624-300
	120	300	Post	SHB401612-300P
	240	300	Post	SHB401624-300P
2 1/2 x 1 1/2	120	350		SHB402412-350
	240	350		SHB402424-350
2 1/2 x 1 3/4	240	500		SHB402824-500
2 1/2 x 2	240	350	24" SS Braid	B017045
	120	500		SHB403212-500
	240	500		SHB403224-500
2 1/2 x 2 3/8	120	550	Post	SHB403812-550P
	240	550	Post	SHB403824-550P
	120	650	Post	SHB403812-650P
	240	650	Post	SHB403824-650P
3 x 1	240	300	24" SS Braid	B022530
2 1/2 x 3	120	700		SHB404812-700
	240	700		SHB404824-700
2 1/2 x 4	240	850	Post	SHB406424-850P
2 1/2 x 5	240	1150	Post	SHB408024-1150P
	230	900	Post	45982B*
2 3/4 x 1 1/2	120	400		SHB442412-400
	240	400		SHB442424-400

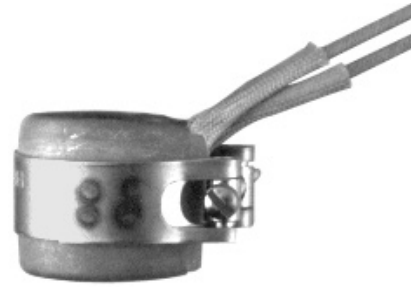

STANDARD MICA HEATER BANDS

*Equal to Van Dorn O.E.M. heater band. Full listing by Van Dorn part number follows these bands.
 **270° coverage, post terminals, padded strap, stainless sheath, high temp. construction. For 2 piece bands, total wattage & voltage are shown

Standard Mica Heater Bands



I.D. × Width	Volts	Watts	10" Flexible Leads Unless Noted	Part Number
3 × 1	120	300		SHB481612-300
	240	300		SHB481624-300
	230	400	Post	12393B*
	460	400	2 pc/Post Terms	51191B*
	460	400		66301B*
	230	400		66302B*
3 × 1½	120	500		SHB482412-500
	220	400	Post	36211B*
	240	500		SHB482424-500
	240	500	12" SS Braid	B030030
3 × 2	120	600		SHB483212-600
	240	600		SHB483224-600
	240	600	12" SS Braid	B030114
3 × 3	120	900		SHB484812-900
	240	900		SHB484824-900
3⅛ × 1	240	400		SHB501624-400
3⅛ × 1½	240	500		SHB502424-500
3¼ × 1	120	350		SHB521612-350
	120	350		SHB561612-350
3½ × 1	240	400	24" SS Braid	B014594
	240	500	12" SS Braid	B027889
3½ × 1½	240	500	Post	SHB562424-500P
	240	650	Post	SHB563224-650P
3⅝ × 1½	230	625	Post	64890B*- Ceramic
	240	625	Post	40978B*
	240	650	Post	SHB602424-650P
4 × 1	240	400	12" SS Braid	B039990
	240	400	24" SS Braid	B018999
	240	625	Post	SHB641624-625P
	240	625	Post	32138B*
4 × 1½	240	625	Post	SHB642424-625P
	220	625	Post	25148B*
	230	400	Post	41989B*
	230	625	18" Leads	303137B*
	460	625	18" Leads	66258B*
	230	625	Post	66952B*-
	230	725	Post	307225B*
4 × 2	240	650	12" SS Braid	B038061
	240	800	12" SS Braid	B037691
	240	800	Post	SHB643224-800P
	460	460	2 pc/**see below	78540B*
	460	1100	Post	307660B*
	230	1250		67736B*- (Ceramic)

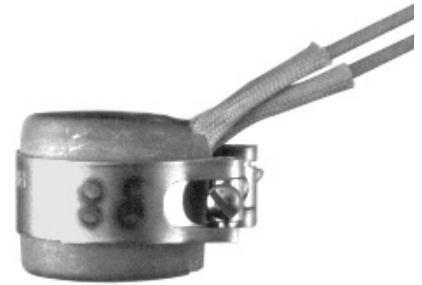

STANDARD MICA HEATER BANDS

*Equal to Van Dorn O.E.M. heater band. Full listing by Van Dorn part number follows these bands.
 **270° coverage, post terminals, padded strap, stainless sheath, high temp. construction. For 2-piece bands, total wattage & voltage are shown.





Standard Mica Heater Bands

I.D. x Width	Volts	Watts	10" Flexible Leads Unless Noted	Part Number
4 x 2¼	120	800		SHB643612-800
4½ x 1½	240	750	Post	SHB722424-750P
4½ x 4	240	1400	24" SS Braid	B036704
5 x 1½	240	800	12" SS Braid	B021068
5 x 2	240	1000	Term Posts	B021396
	240	1000	12" SS Braid	B046757
5⅛ x 1½	230	700	Post	29339B*
5¼ x 1	230	600	Post	65982B*
	460	600	34" Leads	301659B*
5¼ x 1½	230	300	Post	74842B*
	230	600	Post	16526B*
	230	600		64584B*- Ceramic
	230	500	Post	74840B*
	230	1000	Post	12391B*
	230	1000		77685B*- Ceramic
	480	600	2 Pc Post	74842B*
5¼ x 2	460	666	2 pc/**see below	77123B*
5¼ x 3	230	1700	Post	302454B*
5¼ x 4½	230	2400	Post	302456B*
	230	2700	Post	307865B*
5¼ x 5	230	2400	Post	307866B*
5½ x 1½	240	700	24" SS Braid	B041264
5¾ x 1	460	600	34" Leads	307260B*
5¾ x 1½	230	600	Post	28784B*
	230	600	Post	68105B*- Ceramic
	460	1000	Post	302514B*
6 x 1	240	500	48" SS Braid	B014595
6 x 1½	230	600	Post	37587B*
	230	1000	2 pc Post	41987B*
	230	1000	2 pc Post	66821B*- Ceramic
	240	1000	Term Posts	B012799
	460	1000	Post	307863B*
6¾ x 1½	230	815	Post	25147B*
	240	1000	Post	51137B*
	230	600	Post	41988B*
	460	1000	Post	307861B*
6¾ x 2½	460	1150	2 pc/**see below	76928B*
6¾ x 4	230	2600	Post	307864B*
6¾ x 6	230	3750	Post	307859B*
	460	3750	Post	307860B*
7½ x 1½	230	815	Post	28786B*
7⅝ x 3	230	2000	Post	27213B*
	230	1800	Post	27214B*

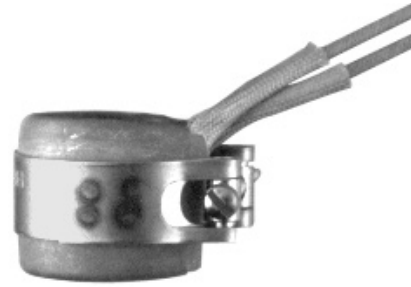

STANDARD MICA HEATER BANDS

Standard Mica Heater Bands



I.D. x Width	Volts	Watts	10" Flexible Leads Unless Noted	Part Number
8¼ x 2	220	1800	2 pc/Post Terms	29347B*
	440	1800	2 pc/Post Terms	31805B*
8¼ x 3	230	1800	Post	37186B*
	230	2000	Post	30465B*
8½ x 4	230	1800	Post	38948B*
9½ x 3	240	2000	Post	29341B*
	460	1930	2 pc/**see below	78541B*
9½ x 6	460	4000	2 pc/Post Terms	38947B*
11 x 3	230	1000	Post	71922B*
11¼ x 3	460	2400	2 pc/Post Terms	45985B*

High Quality & Low,
Low Prices!

*Equal to Van Dorn O.E.M. heater band. Full listing by Van Dorn part number follows these bands.
**270° coverage, post terminals, padded strap, stainless sheath, high temp. construction. For 2-piece bands, total wattage & voltage are shown.

STANDARD MICA HEATER BANDS



Replacement Heater Band Straps

Item	Part Number
Replacement bands for : 1" x 1" Band Strap	HB1STRAP
Replacement bands for: 1½" x 1½" Band Strap	HB112STRAP

REPLACEMENT BAND STRAPS

Replacement strap

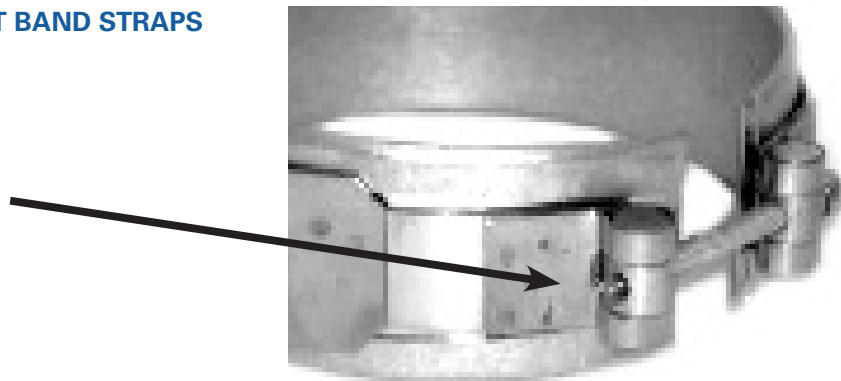



Mica Heater Bands

With Flange Lock-up

Heavy-Duty Nozzle Bands with Flange Lock-up

Far superior to low cost alternatives, these bands provide the most economical option for the long term.

- Premium quality natural mica insulation
- Reinforced lead exit for long life
- High watt density
- Ultra-smooth I.D. bore - reduces hot spots

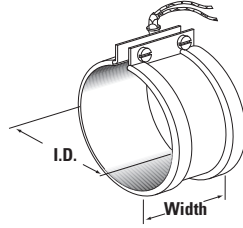

Dual voltage bands (120/240V) can be configured for either voltage

- For 240V, use two red wires as power leads; white wire is not used (insulate with tape)
- For 120V, connect 2 red wires and use as on power lead; use red wire as second lead

Mix and match sizes for maximum discount.

I. D.	Width	Watts	Volts	Lead Length & Configuration	Part Number
7/8"	1"	75W	240	36" Flexible Glass Covered	NB0810A2
1"	1"	100W	120	14" Flexible Glass Covered	NB1010A1
			240		NB1010A2
			120/240		NB1010AD
1"	1 1/2"	150W	120	14" Flexible Glass Covered	NB1015A1
			240		NB1015A2
			120/240		NB1015AD
1"	2"	200W	120	14" Flexible Glass Covered	NB1020A1
			240		NB1020A2
			120/240		NB1020AD
1"	2 1/2"	250W	120	14" Flexible Glass Covered	NB1025A1
			240		NB1025A2
1"	3"	300W	120	14" Flexible Glass Covered	NB1030A1
			240		NB1030A2
1 1/4"	1"	125W	240	14" Flexible Glass Covered	NB1210A2
1 1/4"	1 1/2"	200W	240	14" Flexible Glass Covered	NB1215A2
1 1/4"	2"	250W	240	14" Flexible Glass Covered	SHB203224-250
1 1/4"	3"	400W	240	14" Flexible Glass Covered	SHB204824-400
1 3/8"	1"	150W	240	14" Flexible Glass Covered	NB1310A2
1 3/8"	1 1/2"	200W	240	14" Flexible Glass Covered	SHB222024-200
					240
1 3/8"	2"	300W	120/240	14" Flexible Glass Covered	NB1320AD
			240		
1 1/2"	5/8"	100W	120	14" Flexible Glass Covered	NB1506A1
			240		NB1506A2
1 1/2"	1"	150W	120	14" Flexible Glass Covered	NB1510A1
			240		NB1510A2
			120/240		NB1510AD
1 1/2"	1 1/2"	250W	120	14" Flexible Glass Covered	NB1515A1
			240		NB1515A2
			120/240		NB1515AD
1 1/2"	2"	300W	120	14" Flexible Glass Covered	NB1520A1
			240		NB1520A2
			120/240		NB1520AD
			240		36" Flexible S. Steel Armor

MICA HEATER BANDS

Heavy-Duty Nozzle Bands with Flange Lock-up

Far superior to low-cost alternatives, these bands provide the most economical option for the long term.

- Premium quality natural mica insulation
- Reinforced lead exit for long life
- High watt density
- Ultra-smooth I.D. bore - reduces hot spots

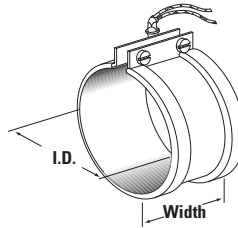

Dual voltage bands (120/240V) can be configured for either voltage

- For 240V, use two red wires as power leads; white wire is not used (insulate with tape)
- For 120V, connect 2 red wires and use as on power lead; use red wire as second lead

Mix and match sizes for maximum discount.

I. D.	Width	Watts	Volts	Lead Length & Configuration	Part Number
1½"	2½"	350W	120	14" Flexible Glass Covered	NB1525A1
			240		NB1525A2
			120/240		NB1525AD
1½"	3"	450W	120	14" Flexible Glass Covered	NB1530A1
			240		NB1530A2
			120/240	14" Flexible S. Steel Armor	NB1530AD
			240		SHB244824-450S
1½"	4"	600W	120	14" Flexible Glass Covered	NB1540A1
			240		NB1540A2
			120/240		NB1540AD
1½"	5"	750W	120	14" Flexible Glass Covered	NB1550A1
			240		NB1550A2
			120/240		NB1550AD
1½"	6"	850W	120	14" Flexible Glass Covered	NB1560A1
			240		NB1560A2
			120/240		NB1560AD
1⅞"	1½"	250W	240	14" Flexible Glass Covered	NB1615A2
1⅞"	2"	325W	120	14" Flexible Glass Covered	NB1620A1
			240		NB1620A2
1¾"	1"	175W	120	14" Flexible Glass Covered	SHB281612-175
			240		NB1710A2
1¾"	1½"	250W	120	14" Flexible Glass Covered	NB1715A1
			240		NB1715A2
			120/240		NB1715AD
1¾"	2"	350W	240	14" Flexible Glass Covered	NB1720A2
			120/240		NB1720AD
1¾"	3"	500W	240	14" Flexible Glass Covered	NB1730A2
			120/240		NB1730AD
1¾"	4"	700W	120	14" Flexible Glass Covered	NB1740A1
			240		NB1740A2
1¾"	5"	900W	240	14" Flexible Glass Covered	NB1750A2
1¾"	6"	1000W	120	14" Flexible Glass Covered	NB1760A1
2"	1"	200W	120	14" Flexible Glass Covered	NB2010A1
			240		NB2010A2

MICA HEATER BANDS





Mica Heater Bands

With Flange Lock-up

Heavy-Duty Nozzle Bands with Flange Lock-up

Far superior to low cost alternatives - these bands provide the most economical option for the long term.

- Premium quality natural mica insulation
- Reinforced lead exit for long life
- High watt density
- Ultra-smooth I.D. bore - reduces hot spots

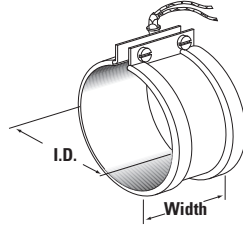

Dual voltage bands (120/240V) can be configured for either voltage

- For 240V, use two red wires as power leads; white wire is not used (insulate with tape)
- For 120V, connect 2 red wires and use as on power lead; use red wire as second lead

Mix and match sizes for maximum discount.

I. D.	Width	Watts	Volts	Lead Length & Configuration	Part Number
2"	1½"	300W	240	14" Flexible Glass Covered	NB2015A2
2"	2"	400W	240	14" Flexible Glass Covered	NB2020A2
2"	2½"	500W	240	14" Flexible Glass Covered	NB2025A2
2"	3"	600W	240	14" Flexible Glass Covered	NB2030A2
2"	4"	800W	120	14" Flexible Glass Covered	NB2040A1
2⅛"	1"	200W	240	14" Flexible Glass Covered	NB2110A2
2⅛"	1½"	300W	240	14" Flexible Glass Covered	NB2115A2
2¼"	1"	225W	240	14" Flexible Glass Covered	NB2210A2
			120/240		NB2210AD
2¼"	3"	700W	120	14" Flexible Glass Covered	NB2230A1
2⅜"	1"	250W	240	14" Flexible Glass Covered	NB2310A2
2⅜"	1½"	400W	120	14" Flexible Glass Covered	NB2315A1
			240		NB2315A2
2½"	1"	250W	240	14" Flexible Glass Covered	NB2510A2
			120/240		NB2510AD
2½"	1½"	375W	120	14" Flexible Glass Covered	NB2515A1
			240		NB2515A2
2½"	2"	500W	120/240	14" Flexible Glass Covered	NB2515AD
			240		NB2520A2
2½"	3"	750W	240	14" Flexible Glass Covered	NB2530A2
			240	36" Flexible S. Steel Armor	NB2530C2
2¾"	1½"	400W	120	14" Flexible Glass Covered	NB2715A1
			240		NB2715A2
3"	1"	300W	120	14" Flexible Glass Covered	NB3010A1
			240		NB3010A2
3"	1½"	450W	240	14" Flexible Glass Covered	NB3015A2
			120/240		NB3015AD
3"	2"	600W	240	14" Flexible Glass Covered	NB3020A2
3"	3"	900W	240	14" Flexible Glass Covered	NB3030A2
3½"	1"	350W	240	14" Flexible Glass Covered	NB3510A2
3½"	1½"	525W	120	14" Flexible Glass Covered	NB3515A1
			240		NB3515A2
3½"	2"	700W	240	14" Flexible Glass Covered	NB3520A2
3½"	2½"	875W	240	14" Flexible Glass Covered	NB3525A2

MICA HEATER BANDS

Wedge-Lock Heater Bands



Where Heater Band Clearance is Problematic! Ideal for Recessed Sprues.

Applications: Use where recessed sprue bushings and similar obstructions create limited space for nozzle heater bands. These bands require only $\frac{3}{8}$ " to $\frac{1}{2}$ " diameter clearance. ($\frac{3}{16}$ " to $\frac{1}{4}$ " on a side.)

Example: Using nozzle with $1\frac{1}{2}$ " body diameter plus Wedge-Lock band, the clearance required is only 2" or less.

This band is frequently used in place of regular nozzle bands due to ease of installation and removal.

14" Flexible Fiberglass

Covered Leads

To install, simply slide band over nozzle, then tap tapered key. Band will automatically tighten to snug fit.

To remove, simply tap tapered key in opposite direction, then pull off band.



Wedge type tapered key locking device requires only $\frac{3}{8}$ " to $\frac{1}{2}$ " clearance on diameter.

WEDGE LOCK HEATERS

Dia.	Width	Watts	Part Number	
			120V	240V
1"	1"	100	F1011	F1012
	1½"	150	F1015	F1016
	2"	200	F1021	F1022
	2½"	250	F1025	F1026
	3"	300	F1031	F1032
	4"	400	F1041	F1042
1¼"	1"	125	F1211	F1212
	1½"	200	F1215	F1216
	2"	250	F1221	F1222
	3"	400	F1231	F1232
1⅜"	2"	300	F1321	F1322
1½"	1"	150	F1511	F1512
	1½"	250	F1515	F1516
	2"	300	F1521	F1522
	2½"	350	F1525	F1526
	3"	450	F1531	F1532
	4"	600	F1541	F1542
	5"	750	F1551	F1552
1¾"	1"	175	F1711	F1712
	1½"	250	F1715	F1716
	2"	350	F1721	F1722
	3"	500	F1731	F1732
	4"	700	F1741	F1742
	6"	1000	F1761	F1762
2"	1"	200	F2011	F2012
	1½"	300	F2015	F2016
	2"	400	F2021	F2022
	3"	600	F2031	F2032
	4"	800	F2041	F2042
2½"	1½"	375	F2515	F2516
	2"	500	F2521	F2522
	3"	750	F2531	F2532
3"	1½"	450	F3015	F3016
	2"	600	F3021	F3022
	3"	900	F3031	F3032





Wedge-Lock Heater Bands

Use for Recessed Sprue Bushing Applications...
 Wedge-Type Tapered Locking Heater Bands
 require only $\frac{3}{8}$ " to $\frac{1}{2}$ " clearance on diameter.

Standard 14" or 36" Stainless Steel Armor Leads

14" or 36" flex leads exit 180° from
 heater band opening. Also available
 with longer length stainless steel
 flexible armored lead.

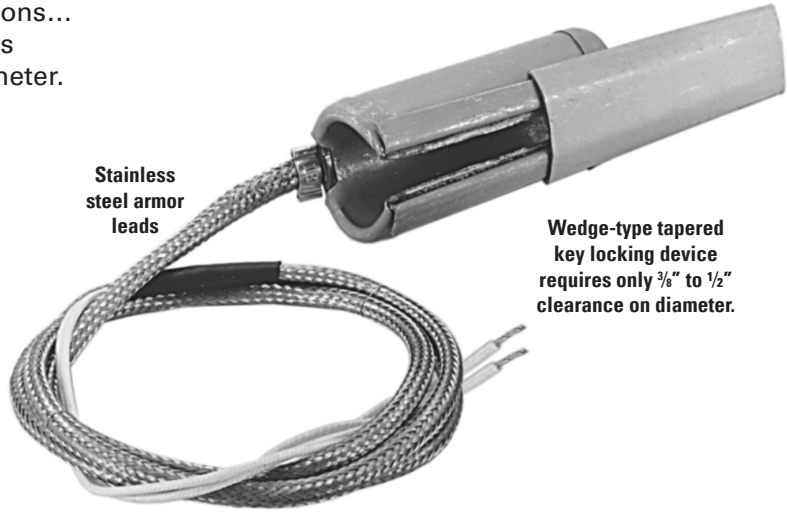

Stainless
 steel armor
 leads

Wedge-type tapered
 key locking device
 requires only $\frac{3}{8}$ " to $\frac{1}{2}$ "
 clearance on diameter.

Dia.	Width	Watts	Volts	14" Stainless	36" Stainless	
				Steel Leads	Steel Leads	
				Part Number	Part Number	
1"	1"	100	120	F1011B	F1011C	
			240	F1012B	F1012C	
	1½"	150	120		F1015C	
			240	F1016B	F1016C	
	2"	200	120	F1021B	F1021C	
			240	F1022B	F1022C	
	2½"	250	120	F1025B	F1025C	
			240	F1026B	F1026C	
	3"	300	120		F1031C	
			240	F1032B	F1032C	
	4"	400	240	F1042B	F1042C	
	3"	400	240		F1232C	
	1⅜"	2"	300	120	F1321B	F1321C
	1½"	1"	150	120	F1511B	F1511C
240					F1512C	
1½"		250	120		F1515C	
			300	F1516B	F1516C	
2"		300	240	F1522B	F1522C	
			120	F1525B	F1525C	
2½"		350	240	F1526B	F1526C	
			120		F1531C	
3"		450	240	F1532B		
			120		F1541C	
4"		600	240	F1542B		
			120	F1551B	F1551C	
5"		750	240	F1552B	F1552C	
			175	F1712B	F1712C	
1¾"	1"	175	240	F1712B	F1712C	
			350	F1722B	F1722C	
	3"	500	120	F1731B	F1731C	
			700		F1741C	
	6"	1000	240	F1762B		

WEDGE LOCK HEATERS

OEM Replacement Bands



Cincinnati Milacron

OEM REPLACEMENT BANDS

OEM Number	Part Number	Type	I.D.	Width	Watts	Volts
326330	CMN00033	Mineral	5	1½	580	240/480
326331	CMN00034	Mineral	6½	1½	1000	240/480
326332	CMN00035	Mineral	7½	1½	900	240/480
326333	CMN00036	Mineral	8	1½	1000	240/480
326334	CMN00037	Mineral	9	1½	1400	240/480
326335	CMN00038	Mineral	10	1½	1200	240/480
326336	CMN00039	Mineral	11	1½	1480	240/480
326337	CMN00040	Mineral	7	1½	580	240/480
326338	CMN00041	Mineral	8	1½	800	240/480
326340	CMN00043	Mineral	9	1½	1100	240/480
326341	CMN00045	Mineral	9½	1½	1000	240/480
326342	CMN00047	Mineral	13	1½	1400	240/480
326344	CMN00049	Mineral	14½	1½	1480	240/480
326346	CMN00051	Mineral	5	1½	770	240/480
326347	CMN00053	Mineral	7	1½	1000	240/480
3901991	CMN00055	Mica	1½	1½	275	120
3901993	CMN00056	Mica	1½	4	500	120
3904526	CMN00057	Mica	1½	1½	300	120
3994402	CMN00058	Mica	5⅞	5¼	2350	240/480
3994523	CMN00059	Mica	7½	7¼	5000	240/480
5021019	CMN00060	Mica	9 ⁷ / ₁₆	2	1700	240/480
5021020	CMN00061	Mica	9 ⁷ / ₁₆	3½	3000	240/480
5021021	CMN00062	Mica	8 ⁷ / ₁₆	4	2100	240/480
5021022	CMN00063	Mica	8 ⁷ / ₁₆	9¼	4900	240/480
5021232	CMN00065	Mica	11 ¹³ / ₁₆	2	2200	240/480
5021233	CMN00066	Mica	11 ¹³ / ₁₆	3½	3900	240/480
5021234	CMN00067	Mica	8 ⁷ / ₁₆	3½	2800	240/480
5021235	CMN00068	Mica	8 ⁷ / ₁₆	8½	6800	240/480
5021402	CMN00069	Mica	4 ¹⁵ / ₁₆	2 ³ / ₈	1000	240/480
5021428	CMN00070	Mica	4 ¹⁵ / ₁₆	2 ³ / ₈	1200	240/480
5022010	CMN00071	Mica	6½	5½	3000	240/480
5022013	CMN00072	Mica	4 ¹⁵ / ₁₆	4	1000	240/480
5022015	CMN00073	Mica	5½	4½	1700	240/480





OEM Replacement Bands

Cincinnati Milacron

OEM REPLACEMENT BANDS

OEM Number	Part Number	Type	I.D.	Width	Watts	Volts
5024377	CMN00074	Mica	10 ⁷ / ₁₆	2	2000	240/480
5024378	CMN00076	Mica	10 ⁷ / ₁₆	3 ¹ / ₂	3300	240/480
5024379	CMN00078	Mica	8 ¹ / ₂	5 ¹ / ₂	3800	240/480
5024380	CMN00079	Mica	8 ¹ / ₂	10	7000	240/480
5025037	CMN00080	Mica	8 ¹ / ₂	7 ⁷ / ₈	7000	240/480
5025306	CMN00081	Mica	8 ¹ / ₂	2	1900	240/480
5027465	CMN00082	Mica	13	2 ¹ / ₂	3000	240/480
5027466	CMN00083	Mica	13	4 ³ / ₄	5000	240/480
5027467	CMN00084	Mica	9 ⁷ / ₁₆	3	2300	240/480
5032143	CMN00086	Mica	7 ¹ / ₂	3 ¹ / ₂	2325	240
5032147	CMN00087	Mica	8 ⁷ / ₁₆	4 ¹ / ₂	2275	240
5032153	CMN00088	Mica	9 ⁷ / ₁₆	4 ⁵ / ₈	3425	240
5033192	CMN00089	Mineral	13	2	3000	240/480
5033194	CMN00090	Mineral	9 ⁷ / ₁₆	4	4000	240/480
5034485	CMN00091	Mineral	9 ⁷ / ₁₆	3	2400	240/480
5034486	CMN00092	Mineral	9 ⁷ / ₁₆	2	1600	240/480
5034487	CMN00093	Mineral	8 ¹ / ₁₆	3	2000	240/480
5035117	CMN00094	Mineral	8 ⁷ / ₁₆	4	2650	240/480
5035761	CMN00095	Mineral	11	4	3500	240/480
5038858	CMN00096	Mineral	5 ⁷ / ₈	5	2350	240/480
5038989	CMN00097	Mineral	4 ¹⁵ / ₁₆	4	1200	240/480
5039028	CMN00098	Mineral	8 ⁷ / ₁₆	5	3250	240/480
5039197	CMN00099	Mineral	6 ¹ / ₂	5	3000	240/480
5039239	CMN00100	Mineral	7 ¹ / ₂	3	2325	240/480
5039247	CMN00101	Mineral	9 ⁷ / ₁₆	3	2300	240/480
3988972-3	CMN00102	Mica	5 ⁷ / ₈	1 ¹ / ₂	675	240/480
3989010-3	CMN00103	Mica	6 ¹ / ₂	1 ¹ / ₂	900	240/480
3989120-4	CMN00104	Mica	7 ¹ / ₂	1 ¹ / ₂	1500	240/480
3990305-3	CMN00105	Mica	5 ¹ / ₂	2 ¹ / ₂	950	240/480
3991263-3	CMN00106	Mica	4 ⁷ / ₈	2 ¹ / ₂	720	240/480

OEM Replacement Bands



Van Dorn

OEM REPLACEMENT BANDS

Part Number	I.D.	Width	Volts	Watts	Leads or One Piece	Terminals
12391B	5¼	1½	230	1000	Yes	Post
12393B	3	1	230	400	Yes	Post
12473B	5¾	1½	230	1000	Yes	Post
16526B	5¼	1½	230	600	Yes	Post
25147B	6¾	1½	220	815	Yes	Post
25148B	4	1½	220	625	Yes	Post
27213B	7⅞	3	230	2000	Yes	Post
27214B	7⅞	3	230	1800	Yes	Post
28784B	5¾	1½	230	600	Yes	Post
28786B	7½	1½	230	815	Yes	Post
29339B	5⅞	1½	230	700	Yes	Post
29341B	9½	3	240	2000	Yes	Post
29347B	8¼	2	220	1800	2 pc.	Post
301659B	5¼	1	460	600	Yes	34" Leads
302454B	5¼	3	230	1700	Yes	Post
302455B	5¼	4½	230	3300	Yes	Post
302456B	5¼	4½	230	2400	Yes	Post
302457B	5¼	2¼	230	1300	Yes	Post
302458B	5¼	2¼	460	1300	Yes	Post
302459B	3	1	230	400	Yes	100" Leads
302511B	6¾	1½	230	1300	Yes	Post
302512B	5¾	1	460	600	Yes	Post
302514B	5¾	1½	460	1000	Yes	Post
302517B	5¼	1	460	600	Yes	Post
302748B	3	1½	240	500	Yes	Post
302971B	5¼	3	460	1700	Yes	Post
302972B	5¼	4½	460	2400	Yes	Post
303137B	4	1½	230	625	Yes	118" Leads
303142B	6¾	1½	460	1100	Yes	Post
303147B	6¾	5	230	4700	Yes	Post
303150B	6¾	4¼	230	3100	Yes	Post
303152B	7½	1½	230	1100	Yes	Post
303508B	5	2½	230	1300	Yes	172" Leads
304265B	6¾	5	230	3700	Yes	Post
304266B	6¾	4¼	460	3100	Yes	Post
304624B	6	1½	460	1100	2 pc.	Post
30465B	8¼	3	230	2000	Yes	Post
305562B	4	2¼	230	1100	Yes	Post
305748B	5¼	1½	460	800	Yes	Post
305916B	2½	4	115	1200	Mineral	154" Leads
307223B	3⅞	1½	230	525	Yes	Post
307224B	3⅞	1½	230	650	Yes	Post
307225B	4	1½	230	725	Yes	Post
307228B	6	1½	230	1000	Yes	Post
307232B	6¾	3½	230	2400	Yes	Post





OEM Replacement Bands

Van Dorn

OEM REPLACEMENT BANDS

Part Number	I.D.	Width	Volts	Watts	Leads or One Piece	Terminals
307235B	7 ⁵ / ₈	4 ¹ / ₂	460	3150	Yes	Post
307236B	7 ⁵ / ₈	3 ¹ / ₂	460	2250	Yes	Post
307283B	8 ¹ / ₄	2	460	1600	Yes	Post
307240B	8 ¹ / ₄	4	460	3350	2 pc.	Post
307242B	9 ¹ / ₂	5	460	4500	2 pc.	Post
307245B	11	3	460	2950	2 pc.	Post
307247B	13	3	460	3500	2 pc.	Post
307249B	13	6	460	7000	2 pc.	Post
307260B	5 ³ / ₄	1	460	600	Yes	34" Leads
307293B	8 ¹ / ₄	2 ¹ / ₂	460	2000	2 pc.	Post
307356B	7 ⁵ / ₈	3	460	2200	Yes	Post
307357B	9 ¹ / ₂	5 ¹ / ₂	460	4900	2 pc.	Post
307358B	9 ¹ / ₂	6	460	5300	2 pc.	Post
307359B	9 ¹ / ₂	6	460	5400	2 pc.	Post
307360B	11 ¹ / ₄	5	460	5100	2 pc.	Post
307659B	5 ¹ / ₄	7	460	600	Yes	Post
307660B	4	2	460	1100	Yes	Post
307695B	5 ¹ / ₄	1	460	600	Yes	36" Leads
307857B	9 ¹ / ₂	2	460	1800	2 pc.	Post
307859B	6 ³ / ₄	6	230	3750	Yes	Post
307860B	6 ³ / ₄	6	460	3750	Yes	Post
307861B	6 ³ / ₄	1 ¹ / ₂	460	1000	Yes	Post
307862B	6 ³ / ₄	3 ¹ / ₂	460	2400	Yes	Post
307863B	6	1 ¹ / ₂	460	1000	Yes	Post
307864B	6 ³ / ₄	4	230	2600	Yes	Post
307865B	5 ¹ / ₄	4 ¹ / ₂	230	2700	Yes	Post
307866B	5 ¹ / ₄	5	230	2400	Yes	Post
307867B	6 ³ / ₄	1 ¹ / ₂	460	1200	Yes	Post
307868B	5 ³ / ₄	1	230	600	Yes	36" Leads
31805B	8 ¹ / ₄	2	440	1800	2 pc.	Post
32138B	4	1	240	625	Yes	Post
36210B	2 ³ / ₈	1	240	250	Yes	Post
36211B	3	1 ¹ / ₂	220	450	Yes	Post
37186B	8 ¹ / ₄	3	230	1800	Yes	Post
37587B	6	1 ¹ / ₂	230	600	Yes	Post
38947B	9 ¹ / ₂	6	460	4000	2 pc.	Post
38948B	8 ¹ / ₂	4	230	1800	2 pc.	Post
40978B	3 ⁵ / ₈	1 ¹ / ₂	240	625	Yes	Post
41987B	6	1 ¹ / ₂	230	1000	2 pc.	Post
41988B	6 ³ / ₄	1 ¹ / ₂	230	600	Yes	Post
41989B	4	1 ¹ / ₂	230	400	Yes	Post
45982B	2 ¹ / ₂	5	230	900	Yes	Post
45983B	5 ¹ / ₂	3	230	1000	Yes	Post
45985B	11 ¹ / ₄	3	460	2400	2 pc.	Post
47937B	2 ³ / ₈	1	460	250	Yes	Post

OEM Replacement Bands



Van Dorn

OEM REPLACEMENT BANDS

Part Number	I.D.	Width	Volts	Watts	Leads or One Piece	Terminals
50070B	4	1	460	626	2 pc.	Post
50071B	4	1½	460	625	Yes	Post
50387B	1½	1½	230	275	Yes	Stainless. 54"
51137B	6¾	1½	240	1000	Yes	Post
51191B	3	1	460	400	2 pc.	Post
51796B	3⅝	1½	460	625	Yes	Post
61367B	7⅝	2	460	1300	2 pc.	Post
64584B	5¼	1½	230	600		Ceramic Bands
64890B	3⅝	1½	230	625		Ceramic Bands
65982B	5¼	1	230	600	Yes	Post
66258B	4	1½	460	625	Yes	18" Leads
66270B	27/16	1	230	250	Yes	70" Leads
66301B	3	1	460	400	Yes	10" Leads
66302B	3	1	230	400	Yes	10" Leads
66821B	6	1½	230	1000		Ceramic Bands
66822B	6¾	1½	230	1000		Ceramic Bands
66952B	4	1½	230	625		Ceramic Bands
67082B	4	1½	460	400	Yes	12" Leads
67729B	8¼	2	230	1800	Yes	Post
67736B	4	2	230	1250		Ceramic Bands
67769B	5⅛	1½	230	700	Yes	168" Leads
67945B	3	1	240	400	Yes	36" Leads
68103B	6¾	1½	230	815		Ceramic Bands
68105B	5¾	1½	230	600		Ceramic Bands
71922B	11	3	230	1000	2 pc.	Post
74840B	5¼	1½	230	500	2 pc.	Post
74842B	5¼	1½	480	600	2 pc.	Post
76928B	6¾	2½	460	1150	2 pc.	See below
77123B	5¼	2	460	666	2 pc.	See below
77529B	7⅝	3	460	1800	2 pc.	Post
77685B	5¼	1½	230	1000		Ceramic Bands
78498B	6¾	1½	460	816	2 pc.	Post
78540B	4	2	460	460	2 pc.	See below
78541B	9½	3	460	1930	2 pc.	See below
99533B	1½	1½	230	275	Yes	144" Leads





Custom Mica Heater Bands

CUSTOM MICA HEATER BANDS

Heater Designs & Construction



PC
Partial Coverage



TYPE W3-A
Post Terminals
Both posts on one side of gap
Minimum I.D. - 3"
Minimum width - 3/4"



TYPE W3-LE
Fiberglass Covered Leads
Leads exit each side of gap
Minimum I.D. - 3/4"
Minimum width - 1"

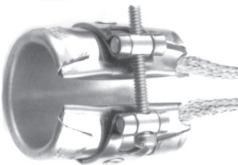

TYPE W3-KS
Stainless Covered Leads
Leads exit each side of gap
Minimum I.D. - 3/4"
Minimum width - 1"



HINGED T7
Separate Straps
Minimum I.D. - 1 1/2"
Minimum width - 1"



TYPE W3-B
Post Terminals
Both posts on one side of gap
Minimum I.D. - 1 1/2"
Minimum width - 3/4"



TYPE W3-L
Fiberglass Covered Leads
Minimum I.D. - 1"
Minimum width - 3/4"



TYPE W3-K
Stainless Covered Leads
Minimum I.D. - 1"
Minimum width - 3/4"

Squares & Rectangles

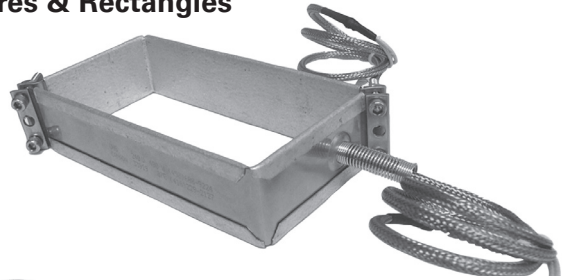

TYPE W3-C
Post Terminals
Both posts on one side of gap
Minimum I.D. - 1 1/2"
Minimum width - 3/4"



TYPE W3-KB
Stainless Steel Covered Leads
Lead exit opposite gap from edge
Min. I.D. - 1/2" Min. width - 1"

European Plugs

W3-EP
Min. I.D. - 1 1/2"

W3-EP90
Min. width - 1"



Terminal Boxes W3-Q
XB Type XB Type
Min. I.D. - 2 1/2" Min. I.D. - 2 1/2"
Min. width - 3/4" Min. width - 1 3/4"



TYPE W3-G
Armor Covered Leads
Minimum I.D. - 1"
Minimum width - 3/4"

Order Your Custom Bands Today!

Standard delivery for non-stock items is 2 - 3 weeks

Rush delivery in 2 - 3 days add 25%

Design Features

- Energy-efficient, less power consumption
- High sheath temperature capability up to 1600°F
- Thermally insulated
- Uniform temperature
- Flexible, easy to install and remove

Terminal Box Cover

Heavy gauge, rust-resistant material has knockouts for ½" conduit connections.

Ceramic Fiber Insulation

The standard insulation is ¼" thick to improve energy conservation 25% or more than non-insulated bands (½" thick insulation optional). In the Maxi-Insulated design, an additional ½" non-compressed layer of insulation is contained in a separate, flexible chamber for even greater energy savings.

Serrated Sheath

Sheath material is resistant to heat and corrosion. Unique serrations maximize flexibility, increase surface contact and provide easy opening and installation of the heater, eliminating the necessity of two-piece band heaters up to 18" in diameter.

Simplified Installation, Additional Energy Conservation

Ceramic Band Heaters can be manufactured in widths much greater than what is practical in Mica Band Heaters, eliminating heat losses between gaps in narrow band heaters and simplifying installation.

Mounting Flange Included Standard

Quick-release latch is optional for ease of installation. Spring-loaded screw on flange is available to compensate for thermal expansion and contraction (over 18" diameter).

Termination

Located at gap or 180° from the gap.

Thermocouple

Should be located through gap or through hole in overlap flange where possible. Contact DME about holes and cut-outs through sheath.



CERAMIC HEATER BANDS

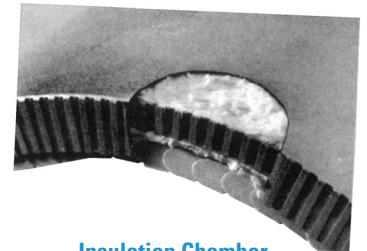

Insulation Chamber

F



Ceramic Heater Bands

Expandable

Expandable Ceramic 1½" Heater Bands

- 240 volt
- 1½" wide
- One size fits many
- Stainless steel sheath
- Terminal boxes — add BX to part number



Part Number	Fits Diameter (mm)	Total Watts	1-½" Wide
CEB-1000-1	4" – 4½" (102–114)	650	
CEB-1002-1	4½" – 5" (114–127)	750	
CEB-1003-1	5" – 5½" (127–140)	825	
CEB-1004-1	5½" – 6" (140–152)	900	
CEB-1005-1	6" – 6½" (152–166)	1000	
CEB-1006-1	6½" – 7" (165–178)	1100	
CEB-1007-1	7" – 7½" (178–190)	1150	
CEB-1008-1	7½" – 8" (190–203)	1250	
CEB-1009-1	8" – 8½" (203–216)	1300	
CEB-1010-1	8½" – 9" (229–241)	1400	
CEB-1011-1	9" – 9½" (229–241)	1500	
CEB-1012-1	9½" – 10" (241–254)	1575	
CEB-1013-1	10" – 10½" (254–267)	1650	
CEB-1014-1	10½" – 11" (267–279)	1725	
CEB-1015-1	11" – 11½" (279–292)	1800	
CEB-1016-1	11½" – 12" (292–305)	1900	

Each band expands over ½"!

CERAMIC HEATER BANDS

A very versatile band - keep them in stock!

Expandable Ceramic 2½" Heater Bands

- 240 volt
- 1½" wide
- One size fits many
- Stainless steel sheath
- Terminal boxes — add BX to part number



Part Number	Fits Diameter (mm)	Total Watts	2-½" Wide
CEB-1000-2	4" – 4½" (102–114)	1100	
CEB-1002-2	4½" – 5" (114–127)	1200	
CEB-1003-2	5" – 5½" (127–140)	1300	
CEB-1004-2	5½" – 6" (140–152)	1500	
CEB-1005-2	6" – 6½" (152–166)	1650	
CEB-1006-2	6½" – 7" (165–178)	1750	
CEB-1007-2	7" – 7½" (178–190)	1900	
CEB-1008-2	7½" – 8" (190–203)	2000	
CEB-1009-2	8" – 8½" (203–216)	2200	
CEB-1010-2	8½" – 9" (229–241)	2300	
CEB-1011-2	9" – 9½" (229–241)	2475	
CEB-1012-2	9½" – 10" (241–254)	2600	
CEB-1013-2	10" – 10½" (254–267)	2750	
CEB-1014-2	10½" – 11" (267–279)	2875	
CEB-1015-2	11" – 11½" (279–292)	3000	
CEB-1016-2	11½" – 12" (292–305)	3100	

Each band expands over ½"!

CERAMIC HEATER BANDS



A very versatile band - keep them in stock!



Mineral Insulated Heater Bands

Designed for Modern High-Temperature Molding Operations

Two fiberglass-insulated lead wires exit in a single metal braid for good abrasion protection, lead flexibility and wiring convenience. Leads are 2" longer than braid. Standard length is 12". Specify if longer leads are required.



Dia.	Width	Watts	Watts/Sq. In.	Volts	Part Number	
1"	1"	100	47	120	MI1010B1X	
		150	70	120	MI1010B1	
					MI101012-150F	
	1½"	1½"	200	58	120	MI1015B1X
			200	58	240	MI1015B2X
			300	87	120	MI1015B1
300			87	240	MI1015B2	
1¼"	1"	250	86	120	MI1210B1	
		250	86	240	MI1210B2	
	1½"	350	75	120	MI1215B1	
		350	75	240	MI1215B2	
1½"	1"	200	54	120	MI1510B1X	
		200	54	240	MI1510B2X	
		300	81	120	MI1510B1	
		300	81	240	MI1510B2	
	1½"	1½"	300	52	120	MI1515B1
			300	52	240	MI1515B2X
			450	77	240	MI1515B2A
			300	38	240	MI1520B2X
	2"	2"	450	57	240	MI1520B2
			350	29	240	MI1530B2X
	3"	3"	500	41	240	MI1530B2
			300	43	120	MI1715B1
1¾"	1½"	300	43	240	MI1715B2	
		350	66	120	MI2010B1	
2"	1"	350	66	240	MI2010B2	
		400	49	240	MI2015B2	
	2"	750	73	240	MI2020B2	
		2¼"	2½"	1000	72	240
2½"	1"	400	58	240	MI2510B2	
	1½"	500	48	240	MI2515B2	

**MINERAL INSULATED
HEATER BAND**

When ordering, specify lead length and terminal location. 12" length leads are standard. For special wattages, voltages or other requirements, please contact DME.

Mineral Insulated Heater Bands



Up to 1400°F and 230 Watts/in. sq.

For today's high melt-temperature engineering materials. Mica bands cannot operate safely above 900°F which makes them inadequate for high-heat engineering materials such as PTFE Ultem, Zytel & Peak. Mineral insulated bands are the solution, capable of continued operating temperatures as high as 1400°F. Also, high thermal conductivity mineral insulation and uniform element construction provide extended life. Optional Ceramic Terminal Covers CTC0124 ordered separately. Includes post terminals, welded on barrel nut hinge, plus clamp.

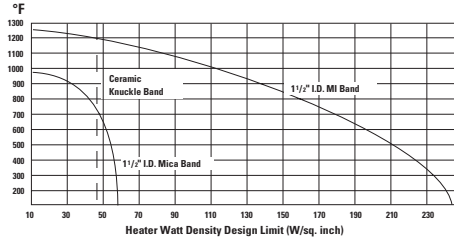

Operating Temperatures up to 1400°F

Very high-watt density for use in high-heat applications.

Dia.	Width	Type	Volts	Watts	Watts/sq. in.	Part Number
3"	1"	1pc.	240	400	51	MI3010P2
		1pc.	240	500	40	MI3015P2
	1½"	2pc.	230/460	525	53	MI3015P4
3½"	2"	1pc.	240	800	42	MI3520P2
3⅝"	1½"	2pc.	230/460	650	51	MI3615P2
4"	1"	1pc.	240	700	62	MI4010P2
		1pc.	240	800	48	MI4015P2
	1½"	2pc.	230/460	625	43	MI4015P4
		2pc.	230/460	725	50	MI4015P5
4½"	2½"	1pc.	240	1250	40	MI4525P2
5"	1½"	2pc.	240/480	1000	52	MI5015P2
		2pc.	240/480	1000	48	MI5215P2
5¼"	1½"	2pc.	230/460	600	29	MI5215P4
		2pc.	230/460	1700	40	MI5230P2
	4½"	2pc.	230/460	2400	38	MI5245P2
		2pc.	230/460	2700	43	MI5245P4
		2pc.	240/480	1000	45	MI5515P2
6"	1½"	2pc.	240/480	1000	41	MI6015P2
6½"	1½"	2pc.	240/480	1250	47	MI6515P2
		2pc.	230/460	815	29	MI6715P2
	2pc.	230/460	1000	36	MI6715P4	
	4"	2pc.	230/460	2600	35	MI6740P2
	5"	2pc.	230/460	3700	40	MI6750P2
7"	1½"	2pc.	230/460	3750	33	MI6760P2
		2pc.	240/480	1250	43	MI7015P2
7½"	1½"	2pc.	240/480	1500	47	MI7515P2
7⅝"	3"	2pc.	230/460	1800	28	MI7630P2
		2pc.	230/460	3150	33	MI7645P2
8"	1½"	2pc.	240/480	1250	37	MI8015P2
		2pc.	240/480	1500	39	MI9015P2
9"	1½"	2pc.	240/480	1500	39	MI9015P2
9½"	3"	2pc.	230/460	3000	37	MI9530P2
11¼"	3"	2pc.	230/460	2400	24	MI11230P2
		2pc.	230/460	5100	31	MI11250P2

MINERAL INSULATED HEATER BAND





Custom Strip Heaters

Time-tested materials & manufacturing techniques make the Custom Strip Heater a proven, economical, reliable performer. In applications where a flat surface requires uniform heating, the strip heater has no equal.

Material List

- 1) Mica provides complete electrical insulation of the heater case from the steel case, while providing maximum heat transfer.
- 2) Flat nickel-alloy ribbon wire provides the highest heating area possible. Each heater is engineered for wire size and pitch to provide the highest efficiency, while minimizing winding temperature.
- 3) The two-piece sheath is composed of a rust-resistant, matte finish, zinc-coated bottom plate and a polished stainless steel top plate. The highly reflective properties of the stainless steel send maximum heat to the working surface. This construction provides excellent heat emissivity and corrosion resistance.
- 4) Stainless steel post terminals are supplied with nuts and washers. Other terminations are available; see below.

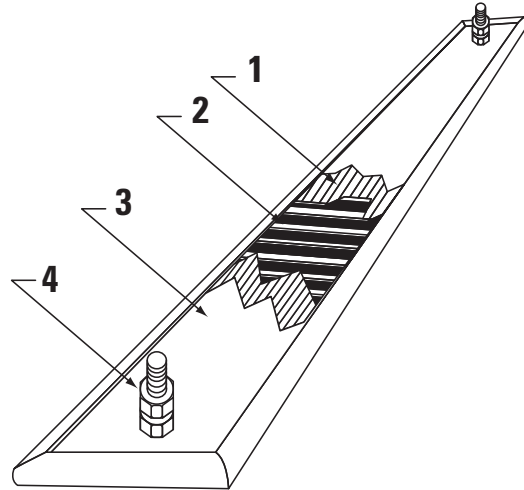

Standard Post Terminal Options

FO-A

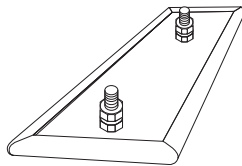

Post Terminals - one on each end; minimum width 3/4"

FO-C

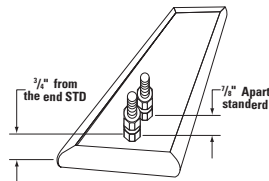

Post Terminals - tandem (inline); minimum width 3/4"

FO-B

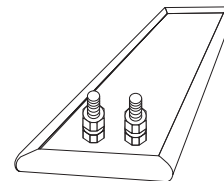

Post Terminals - parallel (side by side); minimum width 3/4"

Optional Terminations

Dual-A-Dual Volt 3PH-A-3 Phase

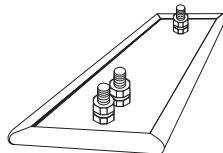

common

Dual-C-Dual Volt 3PH-C-3 Phase

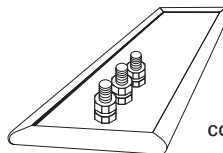

common

Dual-B-Dual Volt 3PH-B-3 Phase

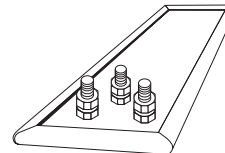

common

Minimum width 1"; 5/8" to 1" wide available but leads will be one on each end

LD

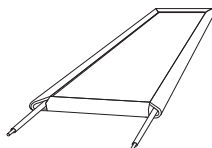

L

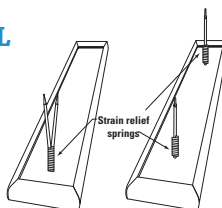

LT

Minimum width 3/4"

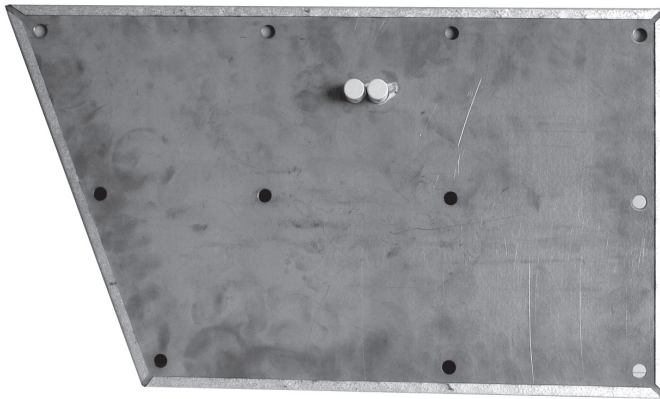
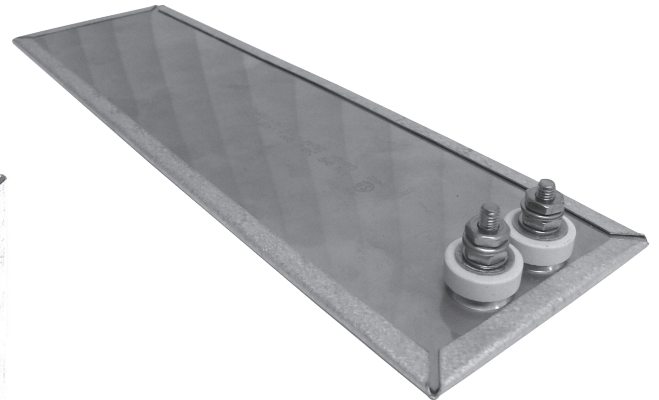
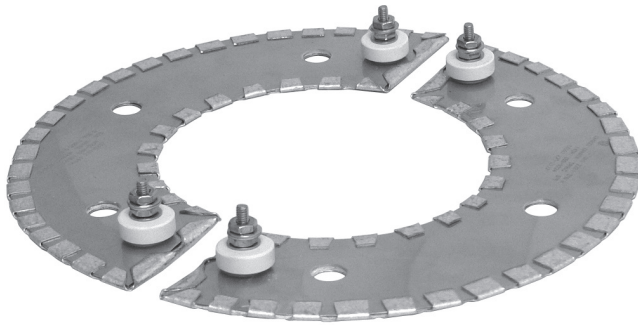

Electric Plugs

Plugs and receptacles for connecting heater bands. Available in basic styles commonly used in European machines. Straight or angled 2-pin plugs with steel or brass prongs in ceramic or rubber insulation with metal case.

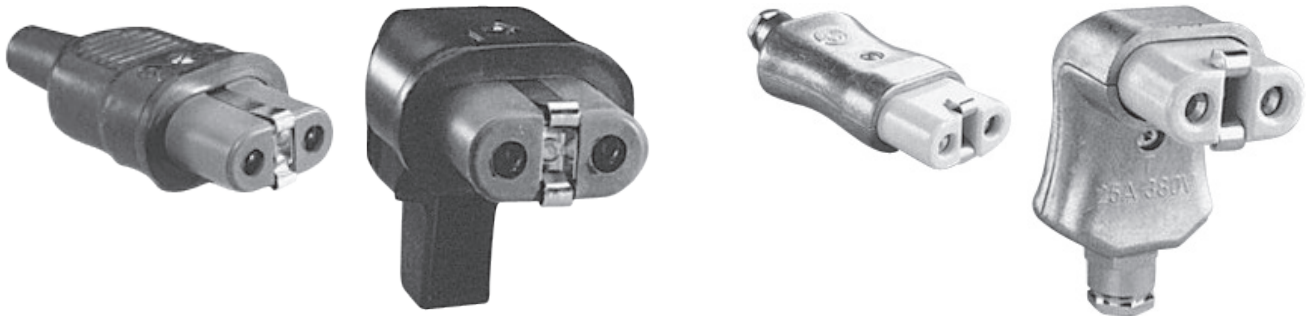

Part Number	Type	AMPS	Configuration
B2M	Silicone Rubber Case	16	Straight Stem
A92M	Silicone Rubber Case	16	90° Angle Stem
B3M	Aluminum Case	25	Straight Stem
A93M	Aluminum Case	25	90° Angle Stem



Silicone Rubber Heaters

Fiberglass reinforced Silicone Rubber Heaters are moisture and chemical resistant. Although thin and flexible, Silicone Rubber Heaters have a rugged construction and can be made to adhere to practically any surface. These heaters can accommodate holes and cutouts, and can come with a PSA back or a thermostat. Silicone Rubber Heaters are suitable for temperatures below 500°F.

C.S.A. Certified!

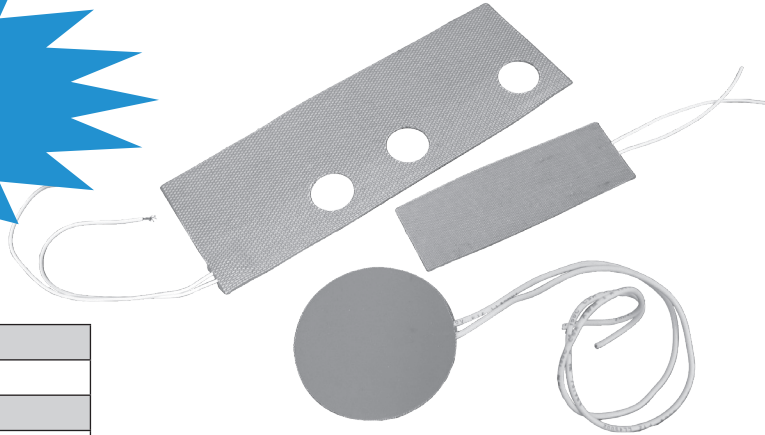

Specifications

Max. Size	38" x 98"
Thickness	0.060"
Max. Temp.	450°F
Max. Voltage	480 VAC
Wattage	+5/-10%
Std. Lead Wire	12" PTFE Insulated
Dielectric Strength	1000 VAC

Immersion Heaters

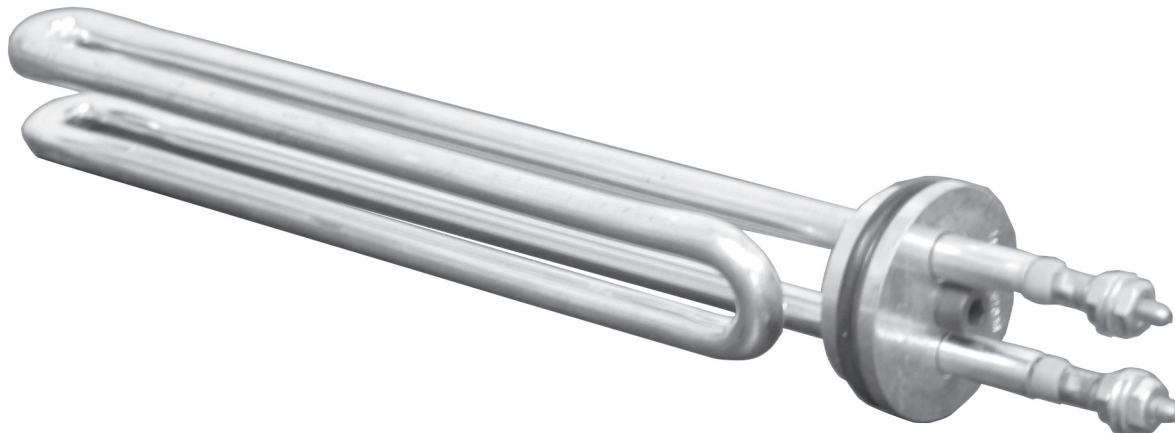

Part Number	Description
30700	Immersion Heater #09-019A, 115V, 650W
30701	Immersion Heater #09-019B, 115V, 1000W
30702	Immersion Heater #09-019C, 115V, 2160W

IMMERSION HEATERS

Important/ Caution: Heated section **MUST** be inside of the groove. A small portion of the unheated section may be inside of the groove.

Any heated section outside and exposed to open air will fail. Also the 30mm cold section on each end **MUST NOT** be bent.

hotset

Disappointed by downtime and waiting for your tubular heater?

- Reduce costly, unnecessary downtime
- Reduce your stocking requirements
- Eliminate tooling or setup costs
- Tap in place with a rubber mallet
- Order today, resume manufacturing tomorrow!

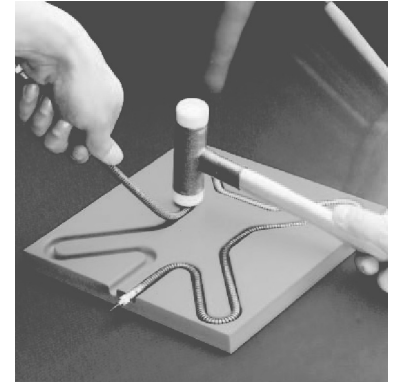

Easily select the correct 8.0mm Hotflex® flexible tubular heater

1. Measure and add total lengths in each category for the diameter that applies to your application.

8.0mm groove ø

	Totals	
2. Length of each straight section	<input type="text"/> × 1 =	<input type="text"/> a
3. Length of each 10mm radius	<input type="text"/> × .92 =	<input type="text"/> b
4. Length of each 12.5mm radius	<input type="text"/> × .93 =	<input type="text"/> c
5. Length of each 15mm radius	<input type="text"/> × .94 =	<input type="text"/> d
6. Length of each >15mm radius	<input type="text"/> × .96 =	<input type="text"/> e
7. Add lines a,b,c,d and e	+	<input type="text"/>
8. Add 60mm for the cold section (30mm + 30mm)	+ 60	<input type="text"/>
9. Round this number down to the nearest 50mm increment		
This is your Hotflex® part number	HTFLX <input type="text"/>	MM

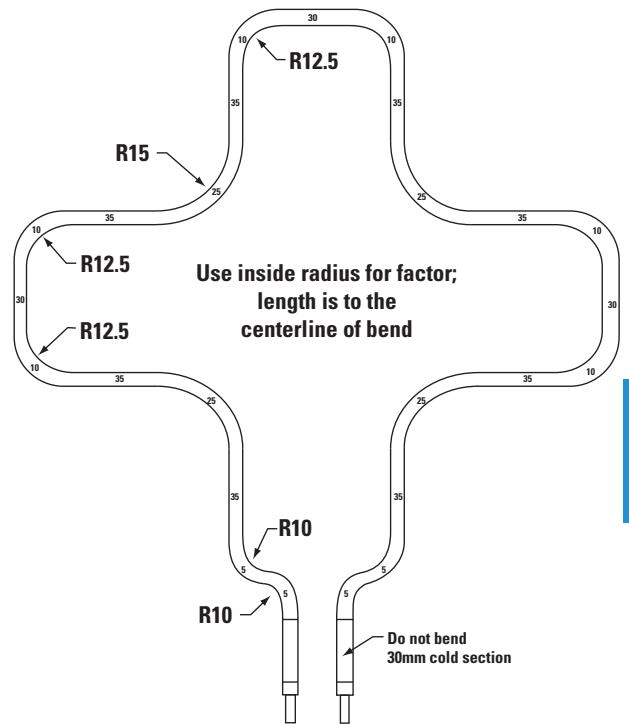

Specifications

Heated flexible stainless steel sheath
 Max. operating temp. = 1292°F
 Min. bending radius = 10mm
 Max. voltage = 250V
 Max. current = 25A
 High-voltage resistance (cold) = 1000 VAC

Current leakage (cold) ≤ 0.5mA at 253 VAC
 Insulation resistance (cold) ≥ 5Mohm at 500 VDC
 Ø tolerance = ± 0.1mm
 Length tolerance = ± 1.5%
 Wattage tolerance = ± 10%
 Surface loading up to 15W/cm²



Flexible Tubular Heaters

Diameter: 8.0mm (0.315")
 Voltage: 240 VAC
 Unheated: 30.0mm (1.18") each end
 Connection: M4 thread w/ hardware (type B)

Part Number	Sheath Length	Heated Length	Sheath Length	Heated Length	Wattage
HTFLX300MM	300mm	240mm	11.81"	9.45"	660
HTFLX350MM	350mm	290mm	13.78"	11.42"	675
HTFLX400MM	400mm	340mm	15.75"	13.39"	795
HTFLX450MM	450mm	390mm	17.72"	15.35"	910
HTFLX500MM	500mm	440mm	19.69"	17.32"	1025
HTFLX550MM	550mm	490mm	21.65"	19.29"	1145
HTFLX600MM	600mm	540mm	23.62"	21.26"	1260

NOT AVAILABLE

PLEASE SEE HOTRUNNER CATALOG

HTFLX1200MM	1200mm	1140mm	47.24"	44.88"	2665
HTFLX1250MM	1250mm	1190mm	49.21"	46.85"	2780
HTFLX1300MM	1300mm	1240mm	51.18"	48.82"	2895
HTFLX1350MM	1350mm	1290mm	53.15"	50.79"	3015
HTFLX1400MM	1400mm	1340mm	55.12"	52.76"	3130
HTFLX1450MM	1450mm	1390mm	57.09"	54.72"	3245
HTFLX1500MM	1500mm	1440mm	59.06"	56.69"	3365

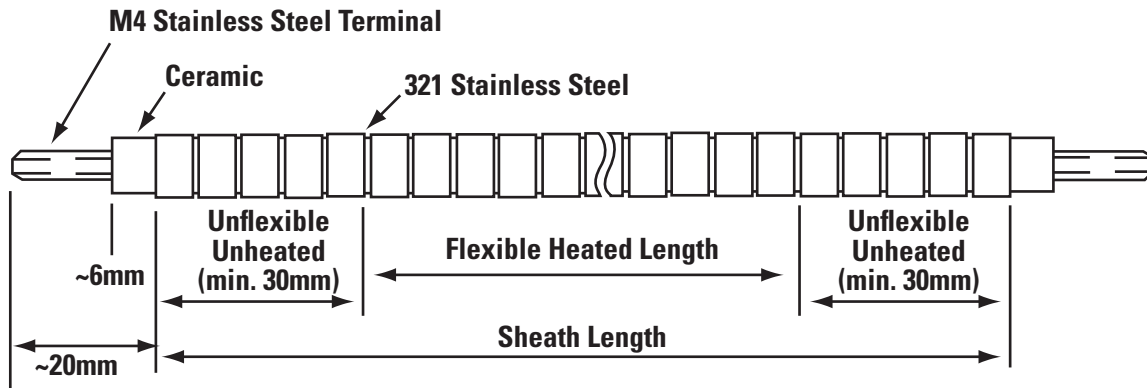

Down and waiting for your tubular heater?
Place your order today, resume manufacturing tomorrow!

Flexible Tubular Heaters



Important/ Caution: Heated section **MUST** be inside of the groove. A small portion of the unheated section may be inside of the groove.

Any heated section outside and exposed to open air will fail. Also the 30mm cold section on each end **MUST NOT** be bent.

hotset

Disappointed by downtime and waiting for your tubular heater?

- Reduce costly, unnecessary downtime
- Reduce your stocking requirements
- Eliminate tooling or setup costs
- Tap in place with a rubber mallet
- Order today, resume manufacturing tomorrow!

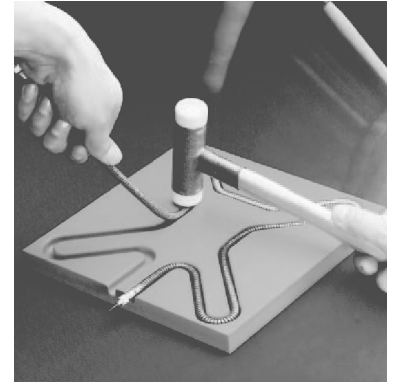

Easily select the correct 8.5mm Hotflex® flexible tubular heater

1. Measure and add total lengths in each category for the diameter that applies to your application.

8.5mm groove ø

	Totals	
2. Length of each straight section	<input type="text"/> × 1 =	<input type="text"/> a
3. Length of each 10mm radius	<input type="text"/> × .94 =	<input type="text"/> b
4. Length of each 12.5mm radius	<input type="text"/> × .95 =	<input type="text"/> c
5. Length of each 15mm radius	<input type="text"/> × .95 =	<input type="text"/> d
6. Length of each >15mm radius	<input type="text"/> × .96 =	<input type="text"/> e
7. Add lines a,b,c,d and e	+	<input type="text"/>
8. Add 60mm for the cold section (30mm + 30mm)	+ 60	<input type="text"/>
9. Round this number down to the nearest 50mm increment		
This is your Hotflex® part number	HF85	<input type="text"/>

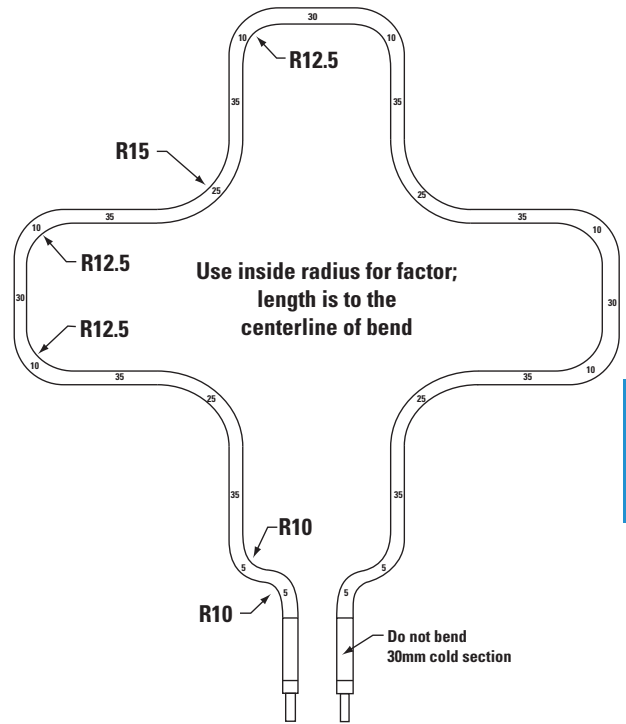

Specifications

Heated flexible stainless steel sheath
 Max. operating temp. = 1292°F
 Min. bending radius = 10mm
 Max. voltage = 250V
 Max. current = 25A
 High voltage resistance (cold) = 1000 VAC

Current leakage (cold) ≤ 0.5mA at 253 VAC
 Insulation resistance (cold) ≥ 5Mohm at 500 VDC
 Ø tolerance = ± 0.1mm
 Length tolerance = ± 1.5%
 Wattage tolerance = ± 10%
 Surface loading up to 15W/cm²



Flexible Tubular Heaters

Diameter: 8.5mm (0.334")

Voltage: 230 VAC

Unheated: 30.0mm (1.18") each end

Connection: M4 thread w/ hardware (type B)

Part Number	Sheath Length	Heated Length	Sheath Length	Heated Length	Wattage
HF85350	350mm	290mm	13.78"	11.42"	750
HF85500	500mm	440mm	19.69"	17.32"	1150

NOT AVAILABLE

PLEASE SEE HOTRUNNER CATALOG

HF851050	1050mm	990mm	41.34"	38.96"	2000
HF851100	1100mm	1040mm	43.31"	40.94"	2930
HF851150	1150mm	1090mm	45.28"	42.91"	3060
HF851200	1200mm	1140mm	47.24"	44.88"	3190

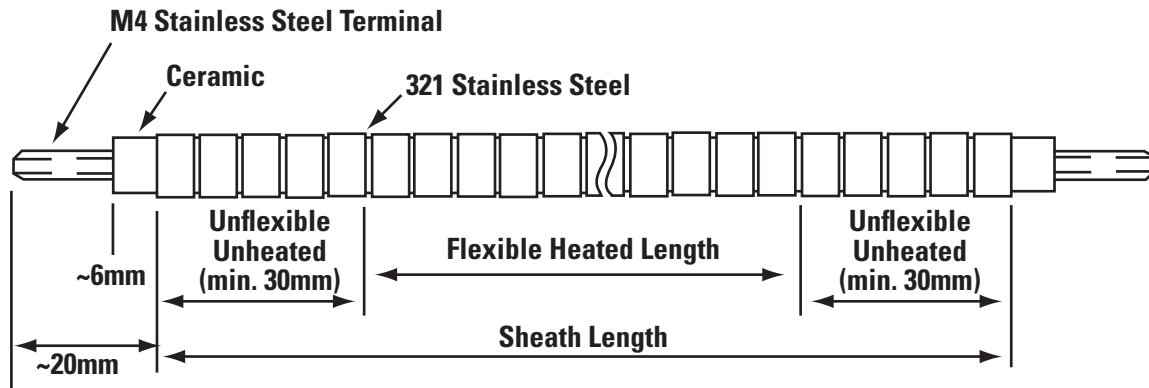

Plug 'n' Heat Ceramic Lead Adapter

- Heat resistant to 230°C (intermittent to 280°C)
- Accepts 1³/₄ AWG wire
- Two required to terminate both ends of Hotflex®
- Part Number PLUGNHEAT

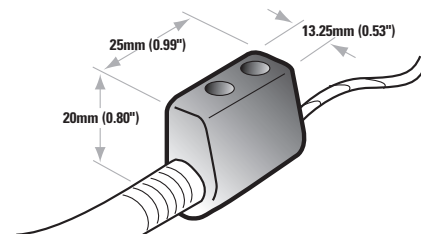

Down and waiting for your tubular heater?
Place your order today, resume manufacturing tomorrow!

Mini Coil Heaters



70 & 80 Series

70 Series Mini Coil Heaters offer a very long life solution to precision-heating applications such as hot runner systems. The hermetically sealed construction prevents moisture from entering the heater, resulting in very long life and long-term resistance stability. A standard resistance tolerance of $\pm 2\%$ produces excellent cavity-to-cavity repeatability in runnerless systems and is easier to control than more loosely tolerated heaters. The heater's nickel sheath is much more efficient for heat transfer than the stainless steel and Inconel sheaths used by other manufacturers, and makes the cold leads more flexible for ease in routing through wiring channels.

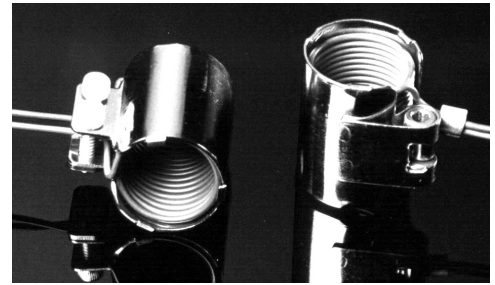

MINI COIL HEATERS

Specifications

Dielectric strength – 800 VAC
 Current leakage – <0.1 mA at 240 VDC (cold)
 Insulation resistance – >100 M Ω at 500 VDC (cold)
 Cable diameter – 0.055" (1.4mm)

Standard Features

Hermetic seal
 72" insulated leadwire
 200 Series nickel sheath

CAM OPERATED - Mini Coil Heaters

Order Number	OEM Number	Rosemount Number	Inside Diameter	Length	Watts at 240 Volts
70A10	534234	904FE-101	3/4"	1.2"	149
70A20	534233	904FE-131	3/4"	1.2"	268

5" & 7" lead lengths

TWIN SCREW - Mini Coil Heaters

Order Number	OEM Number	Rosemount Number	Inside Diameter	Length	Watts at 240 Volts
70B10	520156	904EN/EJ101	3/4"	1.2"	149
70B20	521334	904EN/EJ/FB131	3/4"	1.2"	268
70B40	n/a	904EN/EJ/FB141	7/8"	1.2"	268

5" & 7" lead lengths

WEDGE STYLE AXIAL - Clamp Heaters

Order Number	OEM Number	Rosemount Number	Inside Diameter	Length	Watts at 240 Volts
80A10	534234	n/a	0.75	1.2"	240
80A20	534233	n/a	0.75	1.2"	240

5" & 7" lead lengths

Standard Features

Hermetic seal
 72" insulated leadwire
 200 Series nickel sheath (cold)

Specifications

Dielectric strength – 1000 VAC
 Current leakage – <0.1 mA at 240 VDC (cold)
 Insulation resistance – >100 M Ω at 500 VDC
 Cable diameter – .075" (1.9mm)

Utilizing the same technology as our 70 Series, the 80 Series, larger cross-sectional area results in exceptional electrical properties. As with the 70 Series heaters, the hermetically sealed construction prevents moisture from entering the heater, resulting in very long life and long-term resistance stability. A standard resistance tolerance of $\pm 3\%$ ($\pm 2\%$ upon request) produces excellent cavity-to-cavity repeatability in hot runner systems and is easier to control than more loosely tolerated heaters. The flattened nickel sheath is much more efficient for heat transfer than the SS and Inconel sheaths used by other manufacturers which results in faster heat-up than even our 70 Series. 80 Series mini coil heaters are offered in a variety of sizes, wattages and clamping options. Standard diameters are .750", .875" & 1.000"; other sizes & wattages available on request.

F





Heaters

Kappa® Heaters

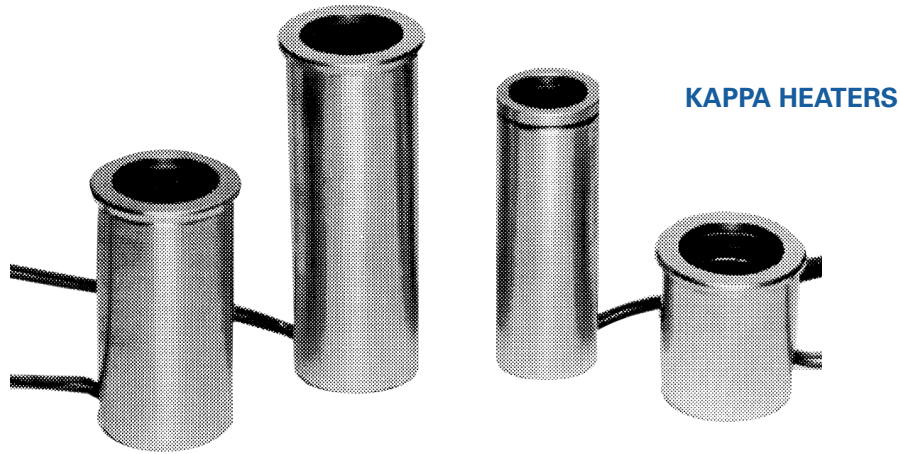

The Kappa Series Heaters are constructed with a nickel-plated copper inner sleeve and a stainless outer sleeve. The heater is tightly sandwiched between these sleeves eliminating the heat transfer problems associated with other dual-sleeved designs. The materials used direct the heat inward toward the nozzle, resulting in a very efficient heater with even heat distribution. The tightly-toleranced I.D. allows a slip fit with no clamping required.

Features

- Slip fit, no clamp required
- Very long life
- Efficient
- Optimum heat distribution
- Profiled heating available
- Low profile

Specifications

- Over 100 watts/in² possible
- 5- and 7-inch cold leads standard
- ± .0005 inch I.D. tolerance
- ± 2% resistance tolerance
- 72-inch lead wires standard
- 0.130" wall thickness

Part Number	OEM P/N	I.D.	Length	Wattage	Volts
75K75	534975	19.05mm	30mm	220W	240V
75K77	534977	19.05mm	50mm	220W	240V
75-400	535181	Cap			

Cartridge Heaters



Standard

- Widely used throughout the industry as a rugged dependable heat source
- High-quality materials and craftsmanship
- 5 diameters offered as standard
- 12" standard high-temperature leads



CATRIDGE HEATERS-CH

Diameter	Sheath Length	Volts	Watts	Watt Density	Part Number
1/4" (.246" ± .002")	1 1/2"	120	75	94	CH41512-75
		240	75	94	CH41524-75
	2"	120	100	125	CH41512-100
		240	150	118	CH42012-150
	2 1/2"	120	150	125	CH42024-150
		240	200	126	CH42512-200
	3"	120	200	126	CH42524-200
		240	200	105	CH43012-200
		240	250	127	CH43012-250
	4"	120	250	127	CH43024-250
		240	300	110	CH44012-300
	240	300	110	CH44024-300	
	5"	240	350	110	CH45024-350
	6"	240	400	95	CH46024-400
3/8" (.371" ± .002")	1"	120	70	88	CH61012-70
	1 1/2"	120	100	86	CH61512-100
		240	150	128	CH61524-150
	2"	120	100	57	CH62012-100
		120	150	85	CH62012-150
		240	150	85	CH62024-150
		240	200	172	CH62012-200
	2 1/4"	240	200	172	CH62024-200
		120	175	86	CH622512-175
	2 1/2"	240	165	75	CH62524-165
		240	185	80	CH62524-185
		240	200	85	CH62524-200
		240	250	106	CH62524-250
		240	300	117	CH62524-300
	3"	120	365	116	CH63012-365
		240	200	68	CH63024-200
		240	250	86	CH63024-250
		240	375	121	CH63024-375
	3 1/2"	120	425	114	CH63512-425
		240	300	85	CH63524-300
		240	425	114	CH63524-425
	4"	120	500	116	CH64012-500
		240	250	62	CH64024-250
		240	350	85	CH64024-350
240		500	117	CH64024-500	





Cartridge Heaters

Standard

- Widely used throughout the industry as a rugged dependable heat source
- High-quality materials and craftsmanship
- 5 diameters offered as standard



CATRIDGE HEATERS-CH

Diameter	Sheath Length	Volts	Watts	Watt Density	Part Number
3/8" (.371" ± .002")	4 1/2"	240	450	95	CH64524-450
	5"	120	650	118	CH65012-650
	5"	240	300	57	CH65024-300
	5 1/2"	240	550	93	CH65524-550
	6"	240	500	78	CH66024-500
	6"	240	600	94	CH66024-600
	6"	240	800	120	CH66024-800
	7"	240	600	80	CH67024-600
	7"	240	800	104	CH67024-800
	8"	120	1090	121	CH68012-1090
	8"	240	600	69	CH68024-600
	8"	240	900	102	CH68024-900
	9"	240	1000	100	CH69024-1000
	10"	240	600	54	CH610024-600
	10"	240	1000	91	CH610024-1000
10"	240	1350	119	CH610024-1350	
12"	240	750	55	CH612024-750	
12"	240	1000	75	CH612024-1000	
1/2" (.496" ± .002")	1 1/2"	120	190	97	CH81512-190
	2"	120	295	126	CH82012-295
	2"	240	200	86	CH82024-200
	2"	240	300	128	CH82024-300
	2 1/4"	120	150	55	CH822512-150
	2 1/4"	240	250	92	CH822524-250
	2 1/2"	120	390	120	CH82512-390
	2 1/2"	240	200	64	CH82524-200
	2 1/2"	240	250	80	CH82524-250
	2 1/2"	240	300	98	CH82524-300
	2 1/2"	240	400	128	CH82524-400
	3"	240	250	64	CH83024-250
	3"	240	300	77	CH83024-300
	3"	240	500	128	CH83024-500
	3 1/2"	240	500	107	CH83524-500
	3 1/2"	240	580	114	CH83524-580
	4"	120	685	117	CH84012-685
	4"	240	300	55	CH84024-300
	4"	240	500	92	CH84024-500
	4"	240	685	117	CH84024-685
	4 1/2"	240	650	103	CH84524-650
	5"	120	880	118	CH85012-880
5"	240	500	72	CH85024-500	
5"	240	750	108	CH85024-750	



Cartridge Heaters



Standard

- Widely used throughout the industry as a rugged dependable heat source
- High-quality materials and craftsmanship
- 5 diameters offered as standard



Diameter	Sheath Length	Volts	Watts	Watt Density	Part Number
1/2" (.496" ± .002")	5"	240	880	118	CH85024-880
	5 1/2"	240	750	95	CH85524-750
	6"	240	500	58	CH86024-500
	6"	240	850	98	CH86024-850
	6"	240	1075	119	CH86024-1075
	6 1/2"	240	900	96	CH86524-900
	7"	240	1000	98	CH87024-1000
	8"	240	750	64	CH88024-750
		240	1000	86	CH88024-1000
		240	1470	121	CH88024-1470
	8 1/2"	120	1000	80	CH88512-1000
	9"	120	1000	76	CH89012-1000
	9 1/2"	240	1250	88	CH89524-1250
	10"	120	1000	67	CH810012-1000
		240	1500	100	CH810024-1500
		240	1860	122	CH810024-1860
10 1/2"	240	1500	96	CH810524-1500	
11"	240	1750	106	CH811024-1750	
12"	120	1000	56	CH812012-1000	
	240	1500	84	CH812024-1500	
	240	2000	112	CH812024-2000	
	240	2200	122	CH812024-2250	
5/8" (.621" ±.002")	2"	240	200	68	CH102024-200
		240	250	73	CH102024-250A
		240	250	85	CH102024-250B
		240	365	103	CH102024-365
	2 1/2"	240	400	102	CH102524-400
	3"	120	600	109	CH103012-600
		240	250	52	CH103024-250
		240	500	104	CH103024-500
	4"	120	850	114	CH104012-850
		240	500	73	CH104024-500
		240	750	110	CH104024-750
	4 1/2"	240	750	96	CH104524-750
	5"	240	500	57	CH105024-500
		240	750	86	CH105924-750
		240	1000	114	CH105024-1000
	5 1/2"	240	750	82	CH105524-750
6"	120	1325	117	CH106012-1325	
	240	850	79	CH106024-850	
	240	1000	93	CH106024-1000	
	240	1325	117	CH106024-1325	

CATRIDGE HEATERS-CH





Cartridge Heaters

Standard

- Widely used throughout the industry as a rugged dependable heat source
- High-quality materials and craftsmanship
- 5 diameters offered as standard
- 12" standard high-temperature leads



CATRIDGE HEATERS-CH

Diameter	Sheath Length	Volts	Watts	Watt Density	Part Number
5/8" (.621" ± .002")	7"	240	800	104	CH107024-800
		120	1590	119	CH107012-1590
		240	1000	78	CH107024-1000
		240	1590	119	CH107024-1590
	7 1/2"	240	1000	73	CH107524-1000
	8"	120	1825	120	CH108012-1825
		240	1000	68	CH108024-1000
		240	1200	82	CH108024-1200
		240	1500	102	CH108024-1500
		240	1825	120	CH108024-1825
	9"	240	1250	75	CH109024-1250
	10"	240	1000	54	CH1010024-1000
	10"	240	1500	81	CH1010024-1500
	10"	240	2325	121	CH1010024-2325
	12"	240	1500	66	CH1012024-1500
12"	240	2000	89	CH1012024-2000	
12"	240	2800	121	CH1012024-2800	
3/4" (.746" ± .002")	2"	120	200	57	CH122012-200
	2 1/2"	240	350	74	CH122524-350
	3"	120	725	168	CH123012-725
	3"	240	400	68	CH123024-400
	3"	240	500	85	CH123024-500
	3"	240	600	102	CH123024-600
	3"	240	725	109	CH123024-725
	3 1/2"	240	550	72	CH123524-550
	4"	240	500	61	CH124024-500
	4"	240	750	91	CH124024-750
	4"	240	1000	117	CH124024-1000
	4"	240	1025	114	CH124024-1025
	4 1/2"	240	875	94	CH124524-875
	5"	240	850	80	CH125024-850
	5"	240	1000	95	CH125024-1000
	5"	240	1300	115	CH125024-1300
	5 1/2"	240	900	77	CH125524-900
	6"	240	1000	77	CH126024-1000
	6"	240	1250	96	CH126024-1250
	6 1/2"	240	1250	88	CH126524-1250



- Widely used throughout the industry as a rugged dependable heat source
- High-quality materials and craftsmanship
- 5 diameters offered as standard

Diameter	Sheath Length	Volts	Watts	Watt Density	Part Number
3/4" (.746" ± .002")	7"	240	1000	66	CH127024-1000
	7"	240	1500	98	CH127024-1500
	8"	240	1750	100	CH128024-1750
	8"	240	2000	114	CH128024-2000
	8"	240	2200	120	CH128024-2200
	9"	240	1800	90	CH129024-1800
	9"	240	2000	100	CH129024-2000
	10"	240	2000	90	CH1210024-2000
	10"	240	2250	112	CH1210024-2250
	12"	240	1500	55	CH1212024-1500

Watlube

Cartridge Heater Release and Heat Transfer Agent

A protective lubricant for use when installing any cartridge heater. It provides a tighter fit, thus improving thermal conductance, permitting higher watt densities and extending heater life.

As a barrier to high temperature oxidation, it assures easy removal of the heater after extended service.

Simple to apply. Avoid contact with leads or end plug.



Size	Part Number
4 oz.	WATLUBE

WATLUBE

F



Cartridge Heaters

Premium quality Cartridge Heaters - Incolloy® sheath provides optimum heat transfer.

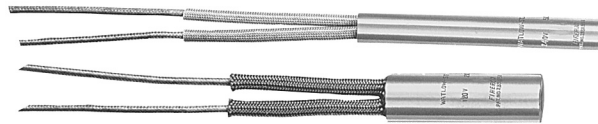

12" standard glass covered leads

Delivery: Standard leads from stock. Alternative lead terminations shipped within 72 hours.

Length	Volts	Watts	Watts /Sq. In.	Part Number
1/8" diameter (nominal) actual 0.122" ± 0.002"				
1 1/4"	120	25	87	C1E14
	120	50	174	C1E13
	240	35	113	C1E42
1 1/2"	120	30	78	C1J5
	120	60	156	C1J6
2"	120	50	87	C2A4
	120	100	174	C2A5
1/4" diameter (nominal) actual 0.246" ± 0.002"				
1"	120	80	208	E1A51
	120	100	260	E1A52
	120	150	390	E1A53
	240	100	250	E1A66
1 1/4"	120	75	130	E1E41
	120	100	173	E1E42
	120	150	260	E1E43
1 1/2"	240	225	390	E1E61
	120	50	65	E1J39
	120	100	130	E1J40
1 1/2"	120	150	195	E1J41
	240	175	228	E1J49
	120	200	260	E1J42
	240	200	260	E1J52
	240	250	325	E1J35
	2"	120	80	68
120		100	87	E2A55
240		125	108	E2A82
120		150	130	E2A56
240		150	130	E2A77
120		200	173	E2A57
240		200	173	E2A50
120		250	217	E2A72
240		250	215	E2A76
240		300	260	E2A83
2 1/2"	120	250	159	E2J80
	240	250	159	E2J49
3"	120	100	52	E3A48
	120	200	104	E3A49
	240	200	104	E3A60
	240	250	128	E3A124
	240	300	156	E3A50
4"	240	300	156	E3A51
	120	100	37	E4A28
4"	120	200	74	E4A29
	240	200	74	E4A32

Length	Volts	Watts	Watts /Sq. In.	Part Number	
1/4" diameter (cont) actual 0.246" ± 0.002"					
4"	120	300	111	E4A30	
	240	300	111	E4A6	
4 1/2"	120	200	64	E4J30	
5"	240	350	101	E5A45	
	120	400	113	E5A57	
	240	400	113	E5A34	
6"	240	400	94	E6A46	
3/8" diameter (nominal) actual 0.371" ± 0.002"					
1"	120	55	95	G1A71	
	120	100	172	G1A29	
	120	150	259	G1A38	
	240	200	344	G1A83	
1 1/4"	120	100	115	G1E91	
	120	125	144	G1E74	
	120	150	172	G1E92	
	240	150	172	G1E93	
	120	200	230	G1E94	
	240	200	230	G1E95	
1 1/2"	120	400	426	G1E99	
	120	100	104	G1F13	
	240	100	104	G1F15	
1 5/8"	120	150	160	G1F17	
	240	160	151	G1G23	
1 7/8"	120	100	94	G1H6	
1 1/2"	120	50	43	G1J25	
	120	75	65	G1J70	
	120	80	68	G1J66	
	120	100	86	G1J59	
	240	100	86	G1J110	
	240	125	106	G1J182	
	120	150	129	G1J31	
	240	150	129	G1J39	
	120	200	173	G1J85	
	240	200	173	G1J73	
	120	250	216	G1J86	
	240	250	216	G1J54	
	1 3/4"	120	125	86	G1N45
		120	175	122	G1N46
120		250	172	G1N43	
1 13/16"	240	250	172	G1N32	
	240	150	98	G1P14	
1 13/16"	120	200	129	G1P15	
	240	250	161	G1P11	
1 7/8"	120	250	152	G1R14	

PREMIUM CARTRIDGE HEATERS

It is recommended that Watlube Heat Transfer Agent & Release Compound be used to improve thermal conductivity, reduce hot spots and increase heater life.

Length	Volts	Watts	Watts /Sq. In.	Part Number
$\frac{3}{8}$ " diameter (nominal) actual 0.371" \pm 0.002"				
2"	120	50	29	G2A53
	120	75	42	G2A192
	120	100	57	G2A84
	240	100	57	G2A76
	120	150	86	G2A56
	240	150	86	G2A81
	120	200	115	G2A127
	240	200	115	G2A37
	120	250	144	G2A47
	240	250	144	G2A73
	120	300	172	G2A139
	240	300	172	G2A98
	120	400	230	G2A153
	240	400	230	G2A146
	120	500	282	G2A95
	240	500	282	G2A97
2 $\frac{1}{8}$ "	240	200	106	G2C13
2 $\frac{1}{4}$ "	120	75	37	G2E88
	120	125	62	G2E89
	240	125	62	G2E138
	240	150	73	G2E68
	120	175	86	G2E90
	120	250	123	G2E2
	240	250	123	G2E78
	120	300	148	G2E108
	240	300	148	G2E12
	120	350	173	G2E91
	240	350	173	G2E75
	2 $\frac{1}{2}$ "	120	200	87
240		200	87	G2J81
120		250	108	G2J46
240		250	108	G2J80
120		300	130	G2J118
240		300	130	G2J119
120		400	174	G2J26
240		400	174	G2J146
120		500	216	G2J109
240		500	216	G2J52
2 $\frac{3}{16}$ "	120	60	122	G2P9
	120	250	92	G2P3
	240	300	110	G2P5
3"	120	100	100	G3A55
	240	100	100	G3A137
	120	150	150	G3A121
	120	200	200	G3A61
	240	200	200	G3A39
	120	250	250	G3A52
	240	250	250	G3A54
	120	300	300	G3A73
	240	300	300	G3A92

Length	Volts	Watts	Watts /Sq. In.	Part Number
$\frac{3}{8}$ " diameter (cont) actual 0.371" \pm 0.002"				
3"	120	400	400	G3A44
	240	400	400	G3A65
	120	500	500	G3A119
	240	500	500	G3A120
	240	600	600	G3A133
3 $\frac{1}{16}$ "	120	500	152	G3F24
3 $\frac{1}{2}$ "	120	250	72	G3J77
	240	250	72	G3J65
	120	300	87	G3J87
	240	300	87	G3J68
	120	500	144	G3J22
	240	500	144	G3J63
3 $\frac{3}{16}$ "	120	150	38	G3P8
	240	500	128	G3P3
4"	120	125	31	G4A54
	240	125	31	G4A163
	120	150	37	G4A78
	120	175	43	G4A191
	120	250	62	G4A40
	240	250	62	G4A87
	120	300	74	G4A94
	240	300	74	G4A95
	120	400	99	G4A48
	240	400	99	G4A44
	240	450	109	G4A65
	120	500	123	G4A96
	240	500	123	G4A92
	120	550	134	G4A200
4 $\frac{1}{4}$ "	240	300	67	G4E25
	240	750	167	G4E15
4 $\frac{1}{2}$ "	120	300	65	G4J54
	240	300	65	G4J33
	120	500	108	G4J55
240	500	108	G4J37	
4 $\frac{3}{16}$ "	240	300	59	G4P11
	240	500	98	G4P3
5"	120	150	29	G5A68
	240	150	29	G5A56
	120	300	58	G5A69
	240	300	58	G5A70
	120	500	96	G5A38
	240	500	96	G5A71
	240	750	144	G5A67
240	1000	192	G5A115	
5 $\frac{1}{4}$ "	240	200	45	G5E16
	240	600	104	G5J36
5 $\frac{1}{2}$ "	240	1000	173	G5J45
	120	200	31	G6A80
6"	120	250	39	G6A40
	240	250	39	G6A92

PREMIUM CARTRIDGE HEATERS





Cartridge Heaters

Premium quality Cartridge Heaters - Incolloy® sheath provides optimum heat transfer.



12" standard glass covered leads

Delivery: Standard leads from stock. Alternative lead terminations shipped within 72 hours.

Length	Volts	Watts	Watts /Sq. In.	Part Number	Length	Volts	Watts	Watts /Sq. In.	Part Number	
$\frac{3}{8}$ " diameter (cont) actual 0.371" ± 0.002"					$\frac{1}{2}$ " diameter (cont) actual 0.496" ± 0.002"					
6"	120	400	63	G6A81	1"	120	50	65	J1A30	
	240	400	63	G6A82		120	150	193	J1A31	
	120	500	79	G6A125	1¼"	120	50	43	J1E50	
	240	500	79	G6A59		120	125	107	J1E51	
	120	600	94	G6A56		240	125	107	J1E58	
	240	600	94	G6A51		240	200	172	J1E52	
	240	750	117	G6A46	240	250	212	J1E88		
	240	1000	157	G6A83	1½"	120	50	32	J1J47	
6½"	240	600	86	G6J23		120	150	97	J1J48	
	240	1000	144	G6J33		240	150	97	J1J96	
7"	120	250	33	G7A40		120	200	128	J1J59	
	240	250	33	G7A32		240	200	128	J1J38	
	240	500	65	G7A30	2"	120	75	32	J2A80	
	120	600	80	G7A41		120	200	86	J2A49	
	240	600	80	G7A42		240	200	86	J2A75	
	240	1000	133	G7A43		120	250	108	J2A85	
7½"	240	600	74	G7J27		240	250	108	J2A71	
	240	1000	124	G7J28		120	300	128	J2A95	
8"	240	750	87	G7P5	240	300	128	J2A96		
	120	300	34	G8A54	120	400	171	J2A81		
	240	300	34	G8A47	240	400	171	J2A82		
	120	400	45	G8A109	2¼"	120	75	28	J2E86	
	120	500	58	G8A81		120	125	46	J2E87	
	240	500	58	G8A32		120	250	92	J2E56	
	120	600	69	G8A53		240	250	92	J2E69	
	240	600	69	G8A37		120	400	147	J2E114	
	240	700	79	G8A98		240	400	147	J2E115	
	240	1000	115	G8A45		120	500	184	J2E6	
240	500	52	G8L3	240		500	184	J2E88		
9"	240	1000	100	G9A37		2⅝"	120	100	34	J2G35
	240	600	57	G9J20			240	100	34	J2G28
9½"	240	1000	96	G9J12	120		250	86	J2G34	
	120	400	36	G10A48	240		250	86	J2G37	
10"	120	600	54	G10A35	120		500	172	J2G36	
	240	600	54	G10A31	240		500	172	J2G38	
	240	1000	91	CH610024-1000	120	100	32	J2J67		
	10⅓/16"	240	375	31	G10P5	240	100	32	J2J57	
12"		120	400	30	G12A45	120	250	81	J2J68	
		120	600	45	G12A29	240	250	81	J2J69	
		240	600	45	G12A46	120	300	96	J2J109	
		240	1000	75	G12A47	240	300	96	J2J110	
		12⅓/16"	240	1000	69	G12P3	120	400	128	J2J81
						240	400	128	J2J82	

PREMIUM CARTRIDGE HEATERS

It is recommended that Watlube Heat Transfer Agent & Release Compound be used to improve thermal conductivity, reduce hot spots and increase heater life.

Length	Volts	Watts	Watts /Sq. In.	Part Number
½" diameter (cont.) actual 0.496" ± 0.002"				
2½"	120	500	161	J2J66
	240	500	161	J2J70
2⅝"	120	350	108	J2K6
	240	300	93	J2K3
2¾"	240	400	115	J2N43
	120	400	115	J2N45
3"	120	125	32	J3A108
	240	125	32	J3A109
	120	250	64	J3A107
	240	250	64	J3A89
	120	300	78	J3A65
	120	350	89	J3A173
	240	300	78	J3A73
	120	400	104	J3A132
	240	400	104	J3A29
	120	500	129	J3A110
	240	500	129	J3A111
	120	600	154	J3A51
	240	600	154	J3A127
	120	750	193	J3A137
240	750	193	J3A112	
120	1000	254	J3A79	
3½"	120	250	54	J3J44
	240	250	54	J3J64
	240	350	75	J3J65
	120	500	107	J3J45
	240	500	107	J3J46
	240	750	162	J3J63
3⅜"	120	500	96	J3P9
	240	250	48	J3P2
4"	120	150	28	J4A117
	240	150	28	J4A122
	120	250	46	J4A118
	240	250	46	J4A90
	120	300	56	J4A63
	240	300	56	J4A26
	120	350	65	J4A1
	240	350	65	J4A103
	120	400	74	J4A139
	240	400	74	J4A68
	120	500	92	J4A16
	120	550	100	J4A242
	240	500	92	J4A92
	120	750	138	J4A198
240	750	138	J4A119	
240	1000	184	J4A73	
4⅝"	120	550	92	J4F5
4½"	120	550	80	J4J69
	240	500	80	J4J57
	120	750	120	J4J70

PREMIUM CARTRIDGE HEATERS

Length	Volts	Watts	Watts /Sq. In.	Part Number
½" diameter (cont.) actual 0.496" ± 0.002"				
4½"	240	750	120	J4J32
4⅜"	240	300	44	J4P3
	240	1000	148	J4P6
5"	120	200	29	J5A85
	240	200	29	J5A74
	120	350	50	J5A86
	240	350	50	J5A63
	120	400	58	J5A98
	240	400	58	J5A46
	120	500	72	J5A52
	240	500	72	J5A45
	120	750	108	J5A121
	240	750	108	J5A72
5½"	240	1000	143	J5A87
	240	200	25	J5J38
	120	500	64	J5J43
	240	500	64	J5J33
	240	650	83	J5J69
	120	750	97	J5J44
5¾"	240	750	97	J5J45
	120	700	86	J5N6
5⅜"	240	700	86	J5N8
	240	300	36	J5P10
6"	120	250	29	J6A114
	240	250	29	J6A171
	240	300	35	J6A66
	240	350	41	J6A119
	120	500	59	J6A115
	240	500	59	J6A94
	120	750	88	J6A99
	240	750	88	J6A90
	240	1000	117	J6A53
	240	1000	117	J6A36
6½"	240	500	54	J6J45
	240	1000	108	J6J27
7"	120	250	25	J7A79
	120	500	50	J7A80
	240	500	50	J7A57
	120	600	60	J7A50
	240	600	60	J7A95
	240	1000	99	J7A81
7½"	240	500	46	J7J25
	240	1000	92	J7J26
8"	120	300	26	J8A71
	240	300	26	J8A111
	120	500	43	J8A64
	240	500	43	J8A66
	120	1000	86	J8A84
	240	1000	86	J8A60
240	1500	129	J8A100	





Cartridge Heaters

Premium quality Cartridge Heaters - Incolloy® sheath provides optimum heat transfer.

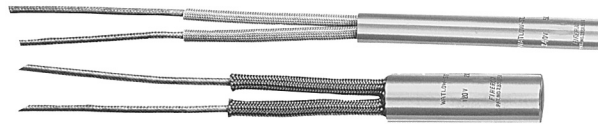

12" standard glass covered leads

Delivery: Standard leads from stock. Alternative lead terminations shipped within 72 hours.

PREMIUM CARTRIDGE HEATERS

Length	Volts	Watts	Watts /Sq. In.	Part Number
½" diameter (cont.) actual 0.496" ± 0.002"				
8"	240	2000	172	J8A101
8½"	240	300	24	J8J39
	240	500	40	J8J30
	240	1000	80	J8J28
9"	240	500	38	J9A35
	240	1000	76	J9A58
9½"	240	500	36	J9J14
	240	1000	72	J9J12
10"	120	500	34	J10A61
	240	500	34	J10A62
	120	1000	68	J10A63
	240	1000	68	J10A42
	240	1500	102	J10A33
11"	240	1000	61	J11A60
	120	500	28	J12A63
12"	240	500	28	J12A76
	120	1000	56	J12A40
	240	1000	56	J12A49
	240	1500	84	J12A37
	240	2000	112	J12A89
14"	240	1000	48	J14A41
	240	2300	110	J14A39
15"	240	1500	66	J15A19
16"	240	1000	41	J16A12
	240	1500	55	J18A19
18"	240	1700	62	J18A23
	⅝" diameter (nominal) actual 0.621" ± 0.002"			
1¼"	120	50	34	L1E26
	120	200	137	L1E24
	120	250	171	L1E27
1½"	120	250	128	L1J23
	240	250	128	L1J24
2"	120	100	34	L2A48
	120	200	68	L2A49
	240	500	170	L2A54
2¼"	120	100	29	L2E49
	120	250	73	L2E50
	240	250	73	L2E12
	120	350	103	L2E40
	240	350	103	L2E51
2⅝"	120	280	77	L2G18
	240	280	77	L2G19
3"	120	150	31	L3A81

Length	Volts	Watts	Watts /Sq. In.	Part Number
⅝" diameter (cont.) actual 0.621" ± 0.002"				
3"	120	250	51	L3A82
	240	250	51	L3A9
	120	400	81	L3A94
	120	500	102	L3A113
	240	500	102	L3A33
	240	750	154	L3A71
3¾"	120	525	82	L3N12
	240	525	82	L3N1
4"	120	250	37	L4A99
	240	250	37	L4A104
	240	400	58	L4A47
	240	500	73	L4A53
	240	600	88	L4A44
	240	750	110	L4A100
5"	120	1000	146	L4A71
	120	250	28	L5A76
	240	250	28	L5A107
	240	500	57	L5A24
	240	750	86	L5A31
5⅝"	240	1000	114	L5A77
	120	800	84	L5G3
6"	240	800	84	L5G1
	120	300	28	L6A28
6"	240	300	28	L6A64
	240	500	47	L6A73
	240	750	70	L6A70
	240	1000	93	L6A71
	120	1500	139	L6A163
6½"	240	1500	139	L6A94
	120	500	43	L6J43
7"	240	500	43	L6J55
	120	500	39	L7A42
	240	500	39	L7A15
8"	240	1000	79	L7A37
	240	1500	118	L7A12
	120	500	34	L8A96
	240	500	34	L8A46
	240	850	58	L8A115
8"	240	1000	68	L8A10
	240	1500	102	L8A37
	240	2000	137	L8A80
10"	120	500	27	L10A51
	240	500	27	L10A40
	240	750	40	L10A69

PREMIUM CARTRIDGE HEATERS

It is recommended that Watlube Heater Release and Heat Transfer Agent be used to improve thermal conductivity, reduce hot spots and increase heater life (see below)

Length	Volts	Watts	Watts /sq.in.	Part Number
5/8" diameter (cont) actual 0.621" ± 0.002"				
10"	240	1000	54	L10A52
	240	1500	81	L10A8
	240	2000	108	L10A50
12"	120	500	22	L12A81
	240	500	22	L12A80
	240	900	40	L12A102
	120	1000	45	L12A82
	240	1000	45	L12A34
	120	1500	66	L12A147
	240	1500	67	L12A39
	240	2000	89	L12A63
14"	240	3700	140	L14A21
15"	240	750	27	L15A35
	240	2400	84	L15A20
	240	4000	141	L15A41
16"	240	2500	82	L16A33
	240	4500	148	L16A40
18"	240	1500	44	L18A32
	240	3000	87	L18A34
	240	4700	137	L18A36
20"	240	1500	40	L20A19
	240	3500	92	L20A13
	240	4700	123	L20A14
24"	240	2000	44	L24A19
	240	4700	102	L24A14
36"	240	3000	43	L36A8
3/4" diameter (nominal) actual 0.746" ± 0.002"				
2"	120	200	49	N2E8
3"	120	250	43	N3A11
	240	500	85	N3A12
4"	120	250	31	N4A16
	240	500	61	N4A17
5"	240	1000	122	N4A15
	120	300	28	N5A19
	240	500	47	N5A12
6"	240	1000	95	N5A20
	120	500	39	N6A19
	240	500	39	N6A20
	240	1000	78	N6A21
7"	240	1500	116	N6A82
	240	2000	155	N6A22
	120	500	33	N7A15
	240	500	33	N7A1
8"	240	1000	66	N7A16
	120	500	28	N8A19
	240	500	28	N8A20
	240	1000	57	N8A21
10"	240	2000	114	N8A22
	240	1000	45	N10A15
	240	2000	90	N10A14

Length	Volts	Watts	Watts /sq.in.	Part Number
3/4" diameter (cont) actual 0.621" ± 0.002"				
12"	240	1000	37	N12A15
	240	2000	74	N12A24
	240	4000	148	N12A25
13"	240	1000	34	N13A26
14"	240	1250	40	N14A22
	240	2500	79	N14A20
	240	4500	142	N14A21
15"	240	1500	44	N15A26
16"	240	1800	49	N16A26
	240	4700	129	N16A18
18"	240	2000	49	N18A13
	240	5000	122	N18A15
20"	240	1150	25	N20A21
	240	2250	49	N20A22
	240	5250	115	N20A10
24"	240	1375	25	N24A24
	240	2750	50	N24A23
	240	5500	100	N24A13
36"	240	2500	30	N36A4

Watlube

Cartridge Heater Release and Heat Transfer Agent

A protective lubricant for use when installing any cartridge heater. It provides a tighter fit, thus improving thermal conductance, permitting higher watt densities and extending heater life.

As a barrier to high temperature oxidation, it assures easy removal of the heater after extended service.

Simple to apply. Avoid contact with leads or end plug.



Size	Part Number
4 oz.	WATLUBE



Cartridge Heaters

Lead Options

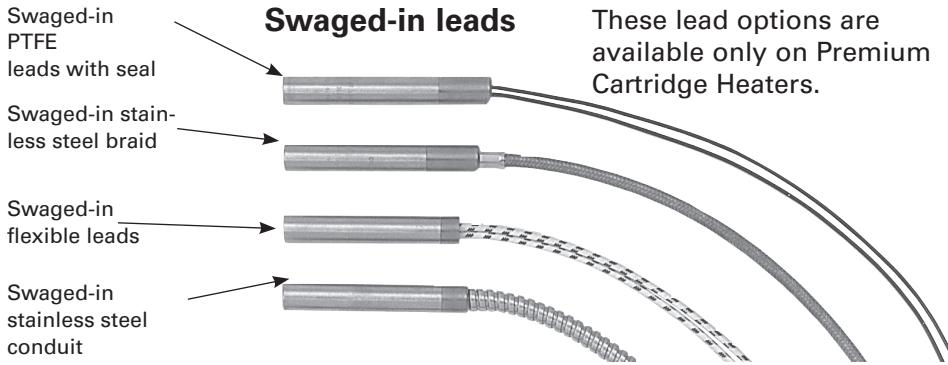

For customers having special requirements, DME offers the lead options shown on these pages. These swaged-in, flexible leads offer a wide choice in terms of capacity, cost, size, durability and ease of installation. Available from stock in any diameter with any lead length.

These lead adaptations are of improved construction and will stand up to extra heavy usage. Unheated sections are reduced up to one-half the area, resulting in lower watt densities and consequent longer life. Leads are flexible over their full length.

Modification Type	Length Dia.	Length Added to Heater	Std. Unheated Portion	Std. Lead Length
Swaged-in flex leads	all	3/16"	7/16"	10"
Swaged-in stainless steel braid	1/4"	3/4"	1"	14"
	3/8"			
	1/2"			
	5/8"			
Swaged-in PTFE	all exc. 1/4" dia.	3/4"	1"	10"
	1/4"			
Swaged-in stainless steel conduit	3/8"	3/8"	5/8"	14"
	1/2"			
	5/8"			
	3/4"			

Right Angle Swaged-In Leads

For applications where space is limited or confining, swaged-in flexible leads are also offered in right angle configuration with lead wires exiting at side of sheath.

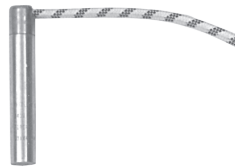

These lead options are available only on Premium Cartridge Heaters.

Modification Type	Dia.	Length added to heater	Unheated portion	Std. lead length
Rt. angle swaged-in flex leads	3/8"	3/8"	5/8"	10"
	others	7/16"	11/16"	
Rt. angle swaged-in stainless steel braid	3/8"	9/16"	13/16"	14"
	1/2"			
	5/8"			
Rt. angle swaged-in stainless steel conduit	3/8"	9/16"	13/16"	14"
	1/2"			
	5/8"			

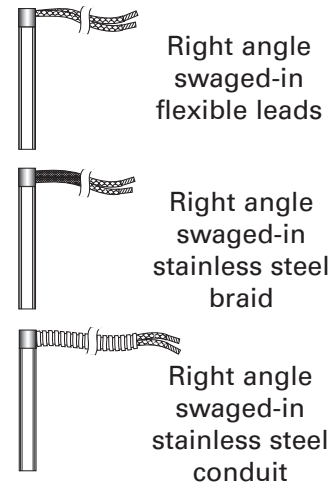

Cartridge Heaters



Thermocouple

- 36" standard, high-temperature leads
- 48" standard, J calibration thermocouple
- Pin leads with high-temperature sleeving



Diameter	Sheath Length	Volts	Watts	Part Number
1/4" .246" (± .002")	1 1/2"	240	200	CH41524-200T
	1 3/4"	240	200	CH417524-200T
	2"	240	200	CH42024-200T
	2 1/2"	240	200	CH42524-200T
	3"	240	200	CH43024-200T
	3 1/2"	240	250	CH43524-250T
	4"	240	250	CH44024-250T
3/8" .371" (± .002")	5"	240	250	CH45024-250T
	1 1/2"	240	200	CH61524-200T
	1 3/4"	240	200	CH617524-200T
	1 3/4"	240	250	CH617524-250T
	2"	240	200	CH62024-200T
	2"	240	250	CH62024-250T
	2 1/2"	240	250	CH62524-250T
	3"	240	260	CH63024-260T
	3"	240	300	CH63024-300T
	3 1/2"	240	320	CH63524-320T
	3 1/2"	240	350	CH63524-350T
	4"	240	370	CH64024-370T
	4 1/2"	240	420	CH64524-420T
	5"	240	300	CH65024-300T
	5"	240	470	CH65024-470T
	5 1/2"	240	525	CH65524-525T
	6"	240	575	CH66024-575T
	6 1/2"	240	625	CH66524-625T
	7"	240	675	CH67024-675T
	7 1/2"	240	724	CH67524-724T
8"	240	775	CH68024-775T	
8 1/2"	240	835	CH68524-835T	
9"	240	885	CH69024-885T	
9 1/2"	240	940	CH69524-940T	
10"	240	990	CH610024-990T	
1/2" .496" (± .002")	1 3/4"	240	230	CH817524-230T
	2 1/2"	240	280	CH82524-280T
	3"	240	500	CH83024-500T
	3 1/2"	240	420	CH83524-420T
	4"	240	490	CH84024-490T
	4 1/2"	240	550	CH84524-550T
	5"	240	625	CH85024-625T
	5 1/2"	240	700	CH85524-700T
	6"	240	775	CH86024-775T
6 1/2"	240	850	CH86524-850T	

CARTRIDGE HEATERS THERMO-COUPLE





Drum Heaters

Our Drum Heater is a portable, lightweight heat source designed for standard drum sizes but versatile enough for use on any similar-sized vessel where quick, adjustable heating is required.

The watt density does not exceed 8.5, so it is suitable for most materials and solutions requiring heat for handling, dipping, coating or mixing.

Features

- Heavy-duty cord & plug on all models
- Rust-resistant stainless steel
- Lightweight, one-piece construction
- Minimum - maximum heat control
- New heavy-duty construction

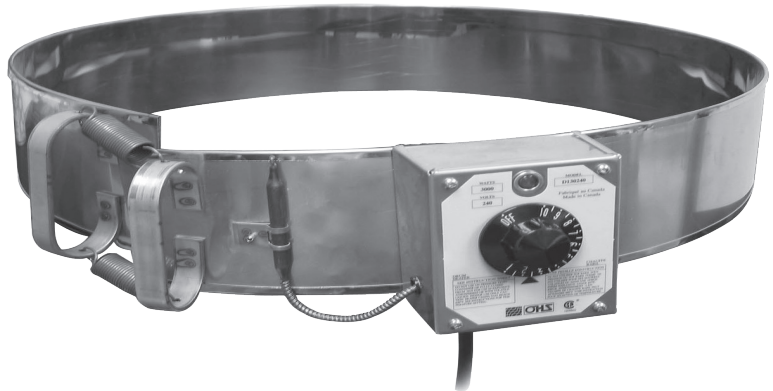

NEW! Secure Latch System Option Add

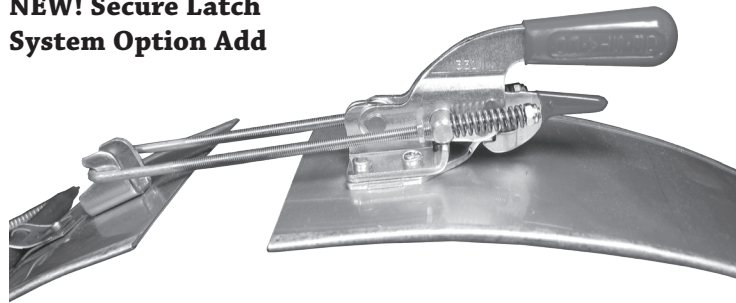

Drum Capacity	Heater Model Number	Volts	Watts	I.D.	Width
45 IMP. GAL. 55 U.S. GAL.	D130120 D130240	120 240	1900 3000	22½"	5"
25 IMP. GAL. 30 U.S. GAL.	D140120 D140240	120 240	1900 2500	18"	5"
5 IMP. GAL. 6 U.S. GAL.	D135120 D135240	120 240	1500 1500	11"	5"

Part Number	Capacity	Volts/Watts
D130120	45 Gal. Metal Drum	120V/1900W
D130240	45 Gal. Metal Drum	240V/3000W
D135120	5 Gal. Metal Drum	120V/1500W
D135240	5 Gal. Metal Drum	240V/1500W
D140120	25 Gal. Metal Drum	120V/1900W
D140240	25 Gal. Metal Drum	240V/2500W

DRUM HEATERS

Cast Heaters are used to heat plastics injection molding and extrusion machinery, packaging machinery, sealer bars, laboratory heaters, hydraulic platens and many applications where durability and extended heater life is important.

Cast Heaters consist of high-quality tubular heaters cast into specific grades of non-ferrous alloys all chosen for excellent thermal conductivity properties.

Cast Heaters can be designed as band heaters, band heaters with cooling tubes, finned band heaters and platen heaters. The Cast Heaters can be supplied with strap lockup or flange lockup, armoured cable leads, terminal posts or protective terminal boxes.

Air-Cooled Finned Heaters

Cast aluminum finned heaters are designed to provide rapid cooling response and temperature control on air-cooled machines and are incorporated as original equipment by many extruder manufacturers.

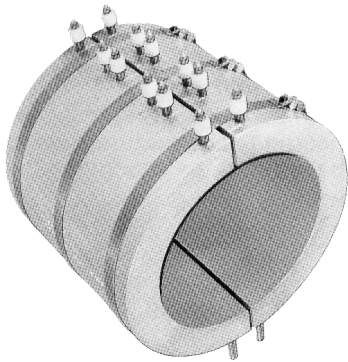

Cylindrical heat and cool heaters for extrusion machinery

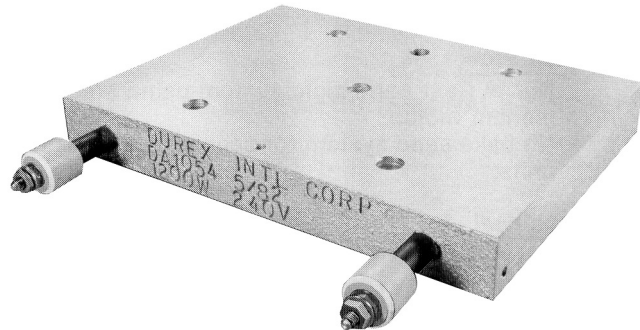

Platen heaters for packaging, food warming & die heating

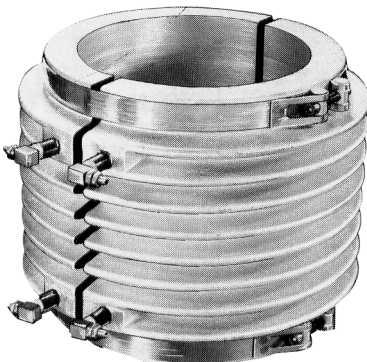

Cylindrical finned heaters for air-cool extrusion machinery

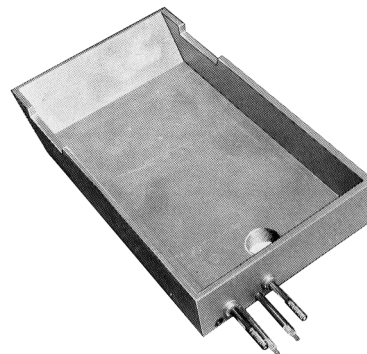

Glue pots and pan heaters for industrial and food warming applications





SCR Power Controls

Power Up/Power Down All Units-Fused and Ready to Mount!

Applications

- Nozzle band heaters
- Hot runners
- Band or cartridge

Features

- Compact and durable design
- Half the price of an electro-mechanical voltage controller
- Solid state reliability
- Low price, high quality

SCR POWER CONTROLS

Model 18TBP/TB Controls

Provide infinitely variable control of single-phase AC voltage to resistive heating elements. These controls are solid-state replacements for variable transformers, saturable core reactors, and electro mechanical contactors. Power Triacs replace contacts and brushes to control electric power without moving parts, and, when operated within their stated ratings for current, voltage, and temperature, have no known life expectancy rating.



18TBP Series, single hole mounting to panels and enclosure doors

Panel- or Chassis-Mount

Model 18TBP controls are compact, lightweight packages that employ single hole mounting to panels and enclosure doors. Model 18TB controls are designed for rear or rack mounting.

Performance Note

Triac power circuits may "slave" when multiple units are used on 240 VAC lines derived from three-phase mains. For optimum performance, use on single phase, 240 VAC derived from 3-wire, 120/240 VAC mains.

Part Number	Input Volts	Max AMPS	Output Voltage
18TBP1-15	120V	15 AMP	0-120
18TBP2-15	240V	15 AMP	0-240

Note: Use only factory-recommended fuses

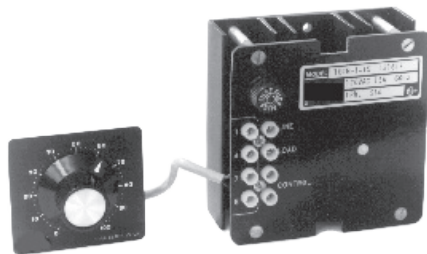

Note: Use only factory-recommended fuses

Part Number	Input Volts	Max AMPS	Output Voltage
18TB1-25	120V	25 AMP	0-120
18TB2-25	240V	25 AMP	0-240

18TB Series designed for rear or rack mounting

18TP Series Features

- 5 and 10 AMP load capacity at 120 or 240 VAC
- Lighted ON/OFF switch
- Built-in "2 millisecond" fuse protection
- 6' power cord with plug
- NEMA standard 120 or 240 VAC receptacle
- Small size - only 4.7" x 3.3" x 2.5"
- Low price, high quality



Part Number	Input Volts	Max AMPS	Output Voltage
18TP1-10	120V	10 AMP	0-120
18TP2-10	240V	10 AMP	0-240

Temp/Process Controller

Fuzzy Pro™

Choose 1/16, 1/8 or 1/4 DIN

These units feature a 10 AMP relay!

Features

- PID - FUZZY or On/Off control
- Heating/cooling + 2 alarms
- Field input selection TC, RTD, linear
- Outputs relay, pulsed DC, 4-20 mA
- Dual display- red/green + LED% output
- Self tuning with inhibited overshoot
- Low panel depth 3 1/8" (80mm)
- 16 ramp/dwell segments option

- Heater saver power limit function
- Multiple alarms on a single output
- Scalable linear input
- Rapid cycling controls faster systems
- Customized operator interface
- Setpoint range limit
- Plug in from front
- Operator lockout security setting



TEMP/PROCESS CONTROLLER

DIN Size	Part Number	Output Type	Alarm or Cooling Output
1/16	F16101	Relay, SPBT 3A/240 VAC	Relay 10A/240V SPST
1/16	F16201	SSR Pulse/20 VDC/20mA	Relay 10A/240V SPST
1/8	F18101	Relay, SPST 3A/240 VAC	Relay 10A/240V SPST
1/4	F14101	Relay, SPST 3A/240 VAC	Relay 10A/240V SPST



Gentran Transducer

Plastic Melt Pressure Transducer GT76

Precise Pressure Measurement

Gentran Models GT72 and GT76 have non-linearity specifications of $\pm 0.5\%$ and $\pm 1.0\%$ of full scale BFSL, respectively. Repeatability for both models is better than 0.1% of full scale.

Easily Installed

These transducers can be installed directly into the extruder, melt pump or other pressure tap. All mating cable assemblies are terminated with spade lugs for simple electrical connection.

Industry Compatible

All Gentran products are configured to industry standards for effortless replacement of parts. We offer compatible units complete with flexible armor stems so that you can replace a transducer without disturbing your existing wiring or indicator configuration.

Versatility

Gentran offers various body lengths, thread dimensions and options for thermocouples. Integral, flexible armored cable is also available. For special applications, we can custom design unique configurations to fit your needs.

Rugged and Durable

Our units last up to six times longer than other units because of our thicker 17-4 PH stainless steel diaphragms that operate from 0 to 750°F.



Ordering Info

Typical Part Number

GT72 /6 J C D6 Z1 -10K

Transducer

Melt Pressure Transducer Model	Barrel Length	Thermocouple Type	Diaphragm Material	Wiring Options	"Z" Options	Pressure Range
GT72 High Accuracy Unit $\pm 0.5\%$	6 6 inch "A" Length	J "J" Type K "K" Type T "T" Type	None 17-4 PH SST C Hard Chrome H Hastelloy C-276	None Standard 6-pin Cannon Connector	None Standard Unit Z1 18" Integral Flexible Armored Cable	5C 0-500* 1K 0-1,000* 1.5K 0-1,500 3K 0-3,000
GT76 Standard Accuracy Unit $\pm 1.0\%$	12 12 inch "A" Length	R "RTD" Type	I Inconel 718 N Titanium Nitride-TIN NN Double Coated TIN	D6 Bendix 6-pin Connector D8 Bendix 8-pin Connector	Z2 24" Integral Flexible Armored Cable Z3 30" Integral Flexible Armored Cable	5K 0-5,000 7.5K 0-7,500 10K 0-10,000 15K 0-15,000 20K 0-20,000* 350BAR 0-350 BAR 700BAR 0-700 BAR 1400BAR 0-1400 BAR 500KG 0-500 kg/cm ² 700KG 0-700 kg/cm ²

Typical Part Number

Cable Assembly

72 04 02 -10

Cable Type	Transducer Type	Connector Type	Cable Length*
72 Standard	04 No Thermocouple	02 Gentran	10 10 Feet
75 Armored	64 "J" Type 74 "K" Type 94 "T" Type 84 "RTD" Type	11 Bendix 8-pin (D8) 13 Bendix 6-pin (D6)	20 20 Feet 40 40 Feet

*Other ranges available upon request.
*Special range.

Plastic Melt Pressure Transducer GT76

Specifications: GT72 & GT76

Performance Characteristics	Electrical Characteristics	Temperature Characteristics	Mechanical Characteristics
<p>Standard Pressure Ranges: 0-1,500 psig, 0-3,000 psig, 0-5,000 psig, 0-10,000 psig, 0-15,000 psig, 0-350 BAR, 0-700 BAR, 0-1,400 BAR, 0-500 kg/cm² 0-700 kg/cm²</p> <p>Special Ranges: 0-500 psig, 0-1,000 psig, 0-20,000 psig Other ranges available upon request</p> <p>Accuracy: GT2: ±0.5% of full scale maximum (BFSL) GT76: ±1.0% of full scale maximum (BFSL)</p> <p>Repeatability: Within ± 0.1% of full scale maximum</p> <p>Resolution: Infinite</p> <p>Overload Pressure: 150% of rated range, no damage</p>	<p>Sensor Type: Bonded strain gauge, 4 Leg Wheatstone Bridge</p> <p>Bridge Resistance: 350 ohms, ±5.0%</p> <p>Sensitivity: 3.0 mV/V nominal (open circuit)</p> <p>Zero Balance: ±10.0%</p> <p>Excitation: 5-12 VDC or AC (RMS), maximum 15 Volts</p> <p>External Shunt Calibration Resistor Standard feature, options available.</p> <p>Insulation Resistance: >1,000 Mohms @ 50 VDC</p> <p>Thermocouple: Types J, K, and RTD available as an Internal option</p>	<p>Diaphragm: 0 to 750°F (-18 to 400°C)</p> <p>Electrical Connector: 0 to 250°F (-18 to 121°C)</p> <p>Zero Drift: ± 0.01% of full scale/°F ± .002% of full scale/°C</p> <p>Sensitivity Drift: ± 0.01% of full scale/°F ± 0.02% of full scale/°C</p>	<p>Diaphragm Material: Standard 17-4 PH Stainless steel, options include Hastelloy, hard chrome plate, Inconel 718 & titanium nitride</p> <p>Pressure Fitting: ½ inch-20 UNF-2A Metric m 18 x 1.5 optional custom options available</p>

Dimensions

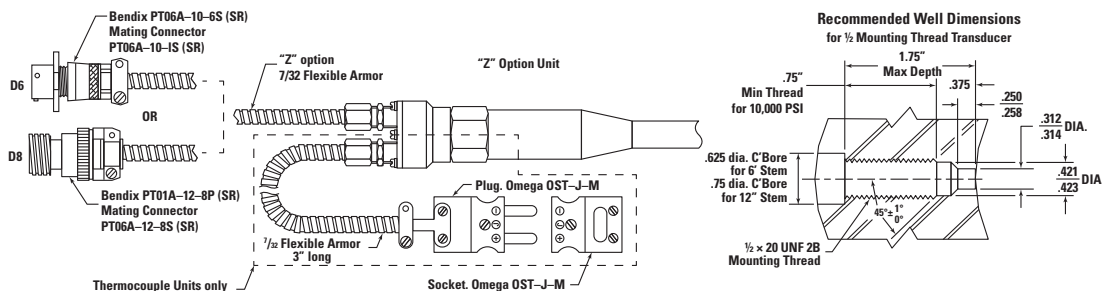
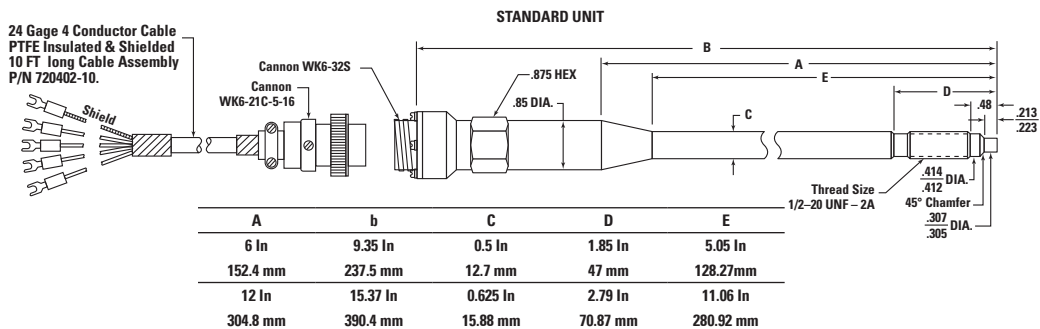



Melt Pressure Gauges

Rigid Stem

Melt Pressure Gauge - Model ERTG

Melt Pressure Gauge Model ERTG is a totally mechanical device, requiring no power. This rugged, totally self-contained Melt Pressure Gauge is available in either 0–5,000 psi or 0–10,000 PSI ranges. This gauge allows the user to benefit from the improved efficiency and quality that goes along with melt pressure monitoring at an affordable price.

Melt Pressure Gauge Model ERTG comes standard with a 6" rigid stem, 1/2–20 UNF mounting thread.

Features & Benefits

- Requires no electrical power and is totally maintenance free
- All stainless steel construction
- Large 4" gauge head with safety glass can be rotated 300° for pressure reading convenience
- Accuracy +/- 2%
- Optional type J or type K thermocouple output

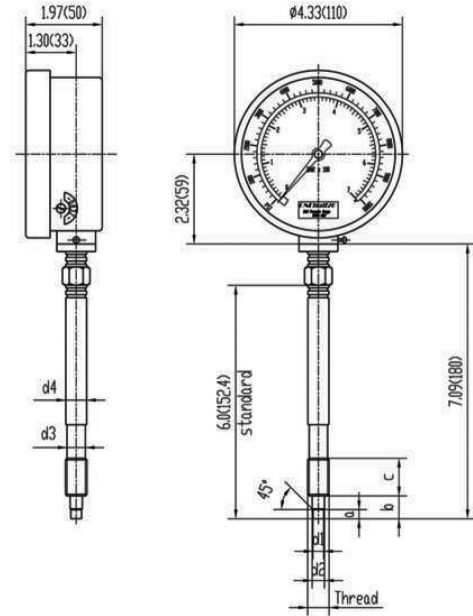

MELT PRESSURE GAUGE RIGID STEM

Thread	d1	d2	a	b	c	d3	d4
1/2" – 20	ø0.307 (7.8)	ø0.413 (10.5)	0.217 (5.5)	0.441 (11.2)	0.629 (16.0)	ø0.41 (10.5)	ø0.5 (12.7)
	ø0.303 (7.7)	ø0.407 (10.35)	0.211 (5.35)	0.233 (11.0)			
M18	ø0.394 (10.0)	ø0.610 (15.5)	0.236 (6.0)	0.551 (14.0)	0.787 (20.0)	ø0.63 (16.0)	ø0.709 (18.0)
	ø0.386 (9.8)	ø0.602 (15.3)	0.230 (5.85)	0.543 (13.8)			

Part Number	Description	Pressure Range	Thermocouple
ERTG6-5M	6" Rigid Stem Only	0–5,000 psi	None
ERTG6-5MTCJ	6" Rigid Stem Only	0–5,000 psi	Type J
ERTG6-5MTCK	6" Rigid Stem Only	0–5,000 psi	Type K
ERTG6-10M	6" Rigid Stem Only	0–10,000 psi	None
ERTG6-10MTCJ	6" Rigid Stem Only	0–10,000 psi	Type J
ERTG6-10MTCK	6" Rigid Stem Only	0–10,000 psi	Type K
ERTG12-5M	12" Rigid Stem Only	0–5,000 psi	None
ERTG12-5MTCJ	12" Rigid Stem Only	0–5,000 psi	Type J
ERTG12-5MTCK	12" Rigid Stem Only	0–5,000 psi	Type K
ERTG12-10M	12" Rigid Stem Only	0–10,000 psi	None
ERTG12-10MTCJ	12" Rigid Stem Only	0–10,000 psi	Type J
ERTG12-10MTCK	12" Rigid Stem Only	0–10,000 psi	Type K

Melt Pressure Gauges



Flexible Stem

MELT PRESSURE GAUGE FLEXIBLE STEM

Melt Pressure Gauge - Model ECTG

Melt Pressure Gauge Model ECTG is a totally mechanical device, requiring no power. This rugged, totally self-contained Melt Pressure Gauge is available in either 0–5,000 psi or 0–10,000 psi ranges. This gauge allows the user to benefit from the improved efficiency and quality that goes along with melt pressure monitoring at an affordable price.

Melt Pressure Gauge Model ECTG comes standard with a 6" rigid stem and 30" of flexible capillary, and 1/2–20 UNF thread.

Features & Benefits

- Requires no electrical power and is totally maintenance free
- All stainless steel construction
- Large 4" gauge head with safety glass can be rotated 300° for pressure reading convenience
- Accuracy +/- 2%
- Optional type J or type K thermocouple output

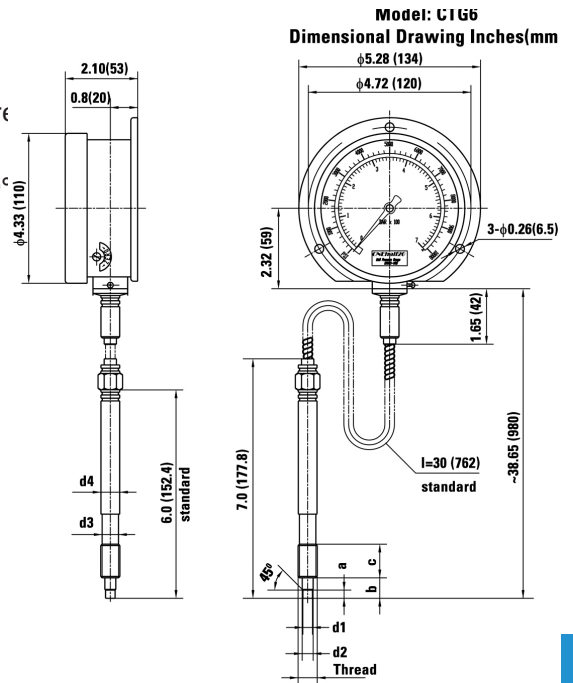
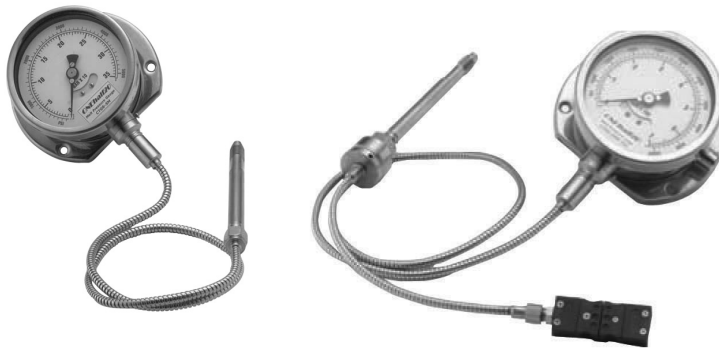

Thread	d1	d2	a	b	c	d3	d4
1/2" - 20	ø0.307 (7.8)	ø0.413 (10.5)	0.217 (5.5)	0.441 (11.2)	0.629 (16.0)	ø0.41 (10.5)	ø0.5 (12.7)
	ø0.303 (7.7)	ø0.407 (10.35)	0.211 (5.35)	0.233 (11.0)			
M18	ø0.394 (10.0)	ø0.610 (15.5)	0.236 (6.0)	0.551 (14.0)	0.787 (20.0)	ø0.63 (16.0)	ø0.709 (18.0)
	ø0.386 (9.8)	ø0.602 (15.3)	0.230 (5.85)	0.543 (13.8)			

Part Number	Description	Pressure Range	Thermocouple
ECTG6-5M	6" Rigid Stem w/30" Capillary	0–5,000 psi	None
ECTG6-5MTCJ	6" Rigid Stem w/30" Capillary	0–5,000 psi	Type J
ECTG6-5MTCK	6" Rigid Stem w/30" Capillary	0–5,000 psi	Type K
ECTG6-10M	6" Rigid Stem w/30" Capillary	0–10,000 psi	None
ECTG6-10MTCJ	6" Rigid Stem w/30" Capillary	0–10,000 psi	Type J
ECTG6-10MTCK	6" Rigid Stem w/30" Capillary	0–10,000 psi	Type K
ECTG12-5M	12" Rigid Stem w/30" Capillary	0–5,000 psi	None
ECTG12-5MTCJ	12" Rigid Stem w/30" Capillary	0–5,000 psi	Type J
ECTG12-5MTCK	12" Rigid Stem w/30" Capillary	0–5,000 psi	Type K
ECTG12-10M	12" Rigid Stem w/30" Capillary	0–10,000 psi	None
ECTG12-10M2TCK	12" Rigid Stem w/30" Capillary	0–10,000 psi	Type K
ECTG12-10MTCJ	12" Rigid Stem w/30" Capillary	0–10,000 psi	Type J



Temperature Controllers

UATC20 Temperature Controllers

The UATC20 Temperature Control Module is a fully microprocessor based unit which has been intelligently designed for Hot Runner Mold Temperature Control Applications where advanced operational and diagnostic features are needed.

The well developed circuitry of the UATC20 produces a module which is simple to operate, rugged and dependable. The advanced diagnostic functions (which are operator programmable to the specific heating zone) provide a snapshot of the operation of that specific heating zone.

Some of the exceptional Analytical functions found on the UATC20 are:

- A diagnostic snapshot of the heater operating characteristics are revealed when the current sensing feature is employed.
- Detects and alerts to the potential dangerous conditions of current leaking to ground.
- If power to the heater exceeds a selected value, the module will alarm and disable power to the heater preventing damage.
- Advanced circuitry detects, alarms and disables power to the heater in the event the triac fails in a shorted condition.
- Heater diagnostics can be performed by checking the average amperage draw of the heater.
- In the event of a thermocouple, open or shorted condition, the module will automatically go into "APO" (Average Power Output) mode, allowing operations to continue by providing the same average power to the heater as applied prior to the failure.
- Real time diagnostics fault detection & error display.
- Audible alarm warns in the case of an error condition.
- A diagnostic snapshot of the heaters operating characteristics are revealed when the current sensing feature is employed.

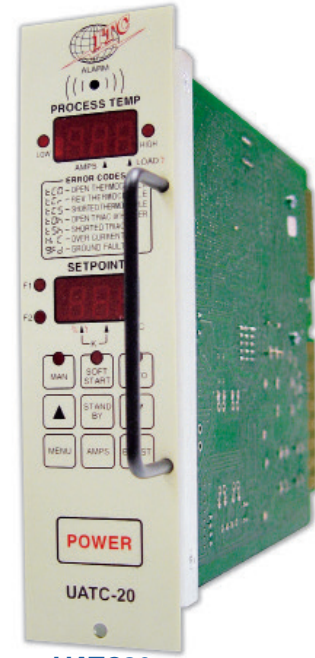

UATC20

The UATC20 Temperature Control Module is a fully microprocessor based instrument, which has been intelligently designed for Hot Runner Mold temperature control applications where advanced operational and diagnostic features are needed. The well developed circuitry of UATC20 produces a full featured module which is simple to operate and will stand up to rigors of harsh environments.

An interesting feature of the UATC20 is its capacity to provide a snapshot of operation of the heating zone by displaying amperage draw. The UATC20 also has the ability to adjust maximum amperage draw to a point just above maximum wattage of the heater. When the controller detects a current which is greater than that value, it will sound an alarm so the offending components can be replaced. This improvement allows for greater operating and maintenance efficiency by detecting leakage in mold wires, cables, heaters, etc. at an early stage.

The Circuitry of the UATC20 provides improved protection to the mold in the event that the triac becomes shorted. This circuitry enables the controller to turn off the power to the heater if it detects continued power draw when the temperature is well above the set point.

ITC has addressed one of the most serious and costly problems of Hot Runner Temperature Controllers by incorporating of our Anti-Arching Feature. This enhancement can greatly reduce the probability of damage to either the main frame or module if a module is accidentally changed while the main frame is under power. This feature alone can save molders lot of money for repair or replacement.

FEATURES

- All features and parameters are fully selectable from the menu feature on the keypad.
- Amperage measuring & display.

- APO (average power output) in thermocouple failure condition.
- Automatic test of "LED" segments.
- Operating voltage 240vac, 50/60 Hz, or 120vac
- Cold junction compensation.
- Zero crossing triac.
- This module operates of ITC's 15 amp main frames.
- Ground Fault Detection – detects if there is a short to ground in the heating circuit. This is selectable range.
- High Amperage Alarm – detects if the amperage draw to the heater exceeds a selectable value which can be
- Entered from the menu.
- Thermocouple – Open, Shorted & Reversed. This is indicated by both an error message and audible alarm.
- Triac – Open and Shorted condition. This is indicated by both an error message and audible alarm.
- High & Low Temperature Condition – Activates when the process temperature varies more than 30° F from set point. This is indicated by both an error message and audible alarm.
- Blown Fuse – This is indicated when the blown fuse "LED" comes on

SAFETY FEATURES:

- High Voltage Thermocouple Protection – Fused
- Module High Current Protection – Fused
- Power Disabled to Heater when:
- Triac is Shorted
- Heater is Open
- High Amperage Condition
- Triac is Open
- Over Temperature Condition
- Audible Alarm

Voltage: 208 to 240vac, single phase

Current: 15 amps

Frequency: 50/60 Hz

Wattage: 3600

On/Off Key: Auto Latching (stays on last setting if power is lost)

Physical Configuration: Plugs in for easy interchangeability

Compatibility: Compatible with "G" Series housings

Size: 2" Wide, 7" High, 7-1/2" Deep

Weight: 1-1/2 #

DC Power Supply: Internally generated regulated and compensated

Module Power Usage: Less than 5 watts, excluding load

Set point Range: 0o to 999o F (537o C)

Control Accuracy: +/- 1o F (0.5o C) dependent on total thermal system

Calibration Accuracy: Better than 0.2% of full range

Operating Temperature Range: 32 to 120 degrees F (0 to 48° C)

Thermocouple: Type J, or Type K grounded or ungrounded

External Thermocouple Resistance: High impedance potentiometer input allows long distance T/C wiring

Output Drive: Internal solid state triac, zero crossing AC pulses

Ground Fault Sensitivity: 60 to 180 mA, default 120 mv.

High/Low Temperature Alarm: Factory set @ +/- 30 degrees F (16° C)

Overload Protection: Fuses on both sides of AC line

Transient Protection: dv/dt and transient pulse suppression

Shorted Triac Heater Protection: Highly sensitive, fast acting relays cut power to load



Temperature Controllers

UATC20 Temperature Controllers

Power Line Isolation: Optically and transformer isolated from AC lines. Isolation voltage greater than 2500 volts

Display: Dual LED displays, 3-digit, 7-segment

Manual Mode: Maintains constant output power to within 1% of manual set power. Adjustable from 0 to 100%

Soft Start: Variable stepped voltage, phase fired

Soft Start Duration: 5 Minutes (Adjustable – 0 to 20) up to 212° F (100° C)

Soft Start Override: Temperature 212° F (100° C)

Operational Modes:

- Soft Start precedes Auto Mode
- Thermocouple break overrides Soft Start and Auto Mode
- Reversed or shorted thermocouple overrides Soft Start and Auto Mode
- Manual Mode overrides thermocouple break, reversed, shorted thermocouple and Auto Mode.
- Output is disabled during all fault conditions.

Cold Junction Compensation: Automatic, better than 0.02°F/F° (0.01°C/C)

Open Thermocouple Protection: Automatically disables power to heater or Average Power Output (APO). Selectable

Reversed Thermocouple Protection: Automatically disables power to heater

Shorted Thermocouple Protection: Automatically disables power to heater or Average Power Output (APO). Selectable

Selectable

Warranty: 2-Years

MFH1

The MFH1 Single Zone Temperature Control System delivers precise temperature control with enhanced diagnostic and control functions. This 10 amp, microprocessor based temperature control system is compact in size, enclosed within a rugged extruded frame and manufactured to standup to the rigors of industrial environments.

Employing the latest in microprocessor technology, the MFH1 offers the user many improved and unique operating features, which provide ease of use, menu selectable flexibility with advanced PID control algorithm for precise control.

Unlike others the MFH1 does not use a wimpy lightweight sheet metal enclosure, but instead the MFH1 uses a robust heavy wall extruded frame which will withstand industrial use.

SUPERIOR FEATURES:

- Compact
- Durable
- Full Featured
- Easy to use
- Enhanced Diagnostic Features

Large, Dual Digital Displays (Temperature, Setpoint, Error Codes)

Audible Alarm

Rear Mounted Fuses

Soft Start "LED" Indicator

Heater Load "LED" Indicator

Bumpless Transfer—APO (average power output)

SELECTABLE FEATURES:

Auto or Manual Operation – LED mode indicator

Type J or K Thermocouple – LED mode indicator

F° or C° Temperature Range – LED mode indicator

Amperage Monitoring & Display – LED indicates

AMP mode

- Audible Alarm – Selectable on /off
- Front Panel Lockout – Selectable on/off



MFH1

MFH1 Temperature Controllers

ENHANCED DIAGNOSTICS:

- High/Low Temperature LED – Selectable Range
- tCr Error Display – Thermocouple Reverse
- tCO Error Display – Thermocouple Open
- tCS Error Display – Thermocouple Shorted
- tOh Error Display – Triac/Heater Open
- tSh Error Display – Triac Shorted
- HiC Error Display – High Amperage Alarm – Selectable Range

SAFETY FEATURES:

- High Voltage Thermocouple Protection (fused)
- Module High Current Protection (fused)
- Electrically Isolated Front Panel
- Power Disabled to Heater:
- Triac Shorted
- Triac Open
- Heater Open
- Over Temperature
- High Amperage

Product Specifications – * Specifications may change without notice

- 208 to 240VAC, single phase
- 50/60 Hz
- 10 Amp Capable
- 2400 Watts
- Size: 6 1/2" Wide, 2" High, 10" Deep
- Control System Power Usage, Less than 5 watts
- Set Point Range – 0° to 999° F
- Control Accuracy – +/- 1° F (0.5° C)
- Calibration Accuracy – Better than 0.2% full range
- Cold Junction Compensation
- Operating Temperature Range -32° to 120° F
- Output Drive – Internal solid state triac, zero crossing AC pulse

OPTIONS:

MPTC10 OR MPTC20 - Single Zone Mold Power / Thermocouple Cable

CKPTM1 - Single Zone Cable End Kit—For Frame End:

NOTE: CKPTM1& MFH1-IPP are provided.

SPECIFICATIONS:

Maximum Amperage: 10 Amps 2400 Watts

Input Power: 240 VAC, Single Phase, 3 wire (2 AC & 1 Ground), 50/60 Hz.

Power to Heater: 240 VAC Single Phase, 50/60 Hz. 10 Amps Max.

Thermocouple: Type "J" or "K"

Mold Interface: Accomplished with an optional combination power and thermocouple cable with ground, Five (5) wire.

(Part No. MPTC10 OR MPTC20).

Dimensions & Weight: 2" (H) x 7" (W) x 11.5" (D) Approx. 7 lbs. (without cables & connectors)

Construction: Totally self contained system with heavy duty extruded aluminum frame: Combination Power & Thermocouple connector (CKPTOC1), 5 pin, female is mounted on rear of cabinet. Input Power Plug (MFH1-IPP) is mounted on rear of cabinet. (Combination Power/Thermocouple connector & Input Power Plug are supplied standard with this system)



Temperature Controllers

MFH1 Temperature Controllers

Accessories – Supplied: CKPTM1 -Cable End Connector (Combination Power/Thermocouple) which plugs into cabinet. MFH1-IPP -Cord End Connector for Input Power Cord (Must use SJO 143 Style & Type of power cord).

- Accessories – Not Supplied: Main Frame Connector (CKPTOC1) Mold Connector (CKPTIC1) Combination Power/Thermocouple Cable (MPTC10 OR MPTC20) Input Power Cord (MFH1-IPC).
- Input Power Cord: CAUTION -If customer is going to make their own input power cord, Use only SJO 14-3 type and style of power cord. Only this type and style of cord will fit the supplied connector.
- Power Usage: Less than 5 watts
- Setpoint Range: 0° to 999° F
- Control Accuracy: +/- 1° F (0.5° C)
- Calibration Accuracy: Better than 0.2% full range
- Operating Temperature Range: -32° F to 120° F
- Output Drive: Internal Solid State Triac, zero crossing, AC pulse
- Transient Protection: dv/dt and transient pulse suppression
- Shorted Triac Heater Protection: Highly sensitive, fast acting relays cut power to load
- Power Line Isolation: Optically and transformer isolated from AC lines. Isolation voltage greater than 2500 volts
- Display: Dual LED displays, 3-digit, 7-segment
- Manual Mode: Maintains constant output power to within 1% of manual set power. Adjustable from 0 to 100%
- Soft Start: Variable stepped voltage, phase fired
- Soft Start Duration: 5 Minutes (Adjustable – 0 to 20) up to 212° F (100° C)
- Soft Start Override: Temperature 212° F (100° C)
- Operational Modes:
 - Soft Start precedes Auto Mode
 - Thermocouple break overrides Soft Start and Auto Mode
 - Reversed or shorted thermocouple overrides Soft Start and Auto Mode
 - Manual Mode overrides thermocouple break, reversed, shorted thermocouple and Auto Mode.
 - Output is disabled during all fault conditions.
- Cold Junction Compensation: Automatic, better than 0.02°F/F° (0.01°C/C)
- Open Thermocouple Protection: Automatically disables power to heater or Average Power Output (APO). Selectable
- Reversed Thermocouple Protection: Automatically disables power to heater
- Shorted Thermocouple Protection: Automatically disables power to heater or Average Power Output (APO). Selectable
- Warranty: 2-Years

Temperature Controllers



NOTE: ITC brand mainframes for USA and Mexico use only. Outside of US please buy the DME standard MFP Main Frame Package.

NOTE: Control cards not included with mainframes.



MF12150

- Input Voltage: 240vac, 3 Phase, 50/60Hz
- Heater Voltage: 240vac, Single Phase
- Max. Amps per Zone: 15 Amps

ACCESSORIES:

- Mold Cable: MPC12C10G, MPC12C20G or MPC12C30G
- Mold TC Cable: TC12C10G, TC12C20G or TC12C30G
- Mold T/C Connector: MTC12G
- Mold Power Connector: PIC12G
- Floor Stand: MFS512G
- Module: UATC20



MF5150

- Input Voltage: 240vac, 3 Phase, 50/60Hz
- Heater Voltage: 240vac, Single Phase
- Max. Amps per Zone: 15 Amps

ACCESSORIES:

- Mold Cable: MPC5C10G, MPC5C20G or MPC5C30G
- Mold TC Cable: TC5C10G, TC5C20G or TC5C30G
- Mold T/C Connector: MTC5G
- Mold Power Connector: PIC5G
- Floor Stand: MFS512G
- Module: UATC20

MF8150

- Input Voltage: 240vac, 3 Phase, 50/60Hz
- Heater Voltage: 240vac, Single Phase
- Max. Amps per Zone: 15 Amps

ACCESSORIES:

- Mold Power Cable: MPC8C10G, MPC8C20G or MPC8C30G
- Mold T/C Cable: TC8C10G, TC8C20G or TC8C30G
- Mold Power Connector: PIC8G
- Mold T/C Connector: MTC8G
- Floor Stand: MFS512G
- Module: UATC20



MF2

- Input Voltage: 240vac, 1 Phase, 50/60Hz
- Heater Voltage: 240vac, Single Phase
- Max. Amps per Zone: 10 Amps
- Total System Watts: 2,400 Watts

ACCESSORIES:

- Mold Cable: MPTC10 or MPTC20 (2 required)
- Mold Connector: CKPTIC1 (2 required)
- Module UATC20

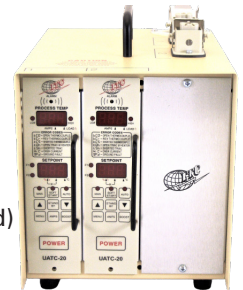

MF1

- Input Voltage: 240vac, 1 Phase, 50/60Hz
- Heater Voltage: 240vac, Single Phase
- Max. Amps per Zone: 10 Amps
- Total System Watts: 2,400 Watts

ACCESSORIES:

- Mold Cable: MPTC10 or MPTC20
- Mold Connector: CKPTIC1
- Module: UATC20

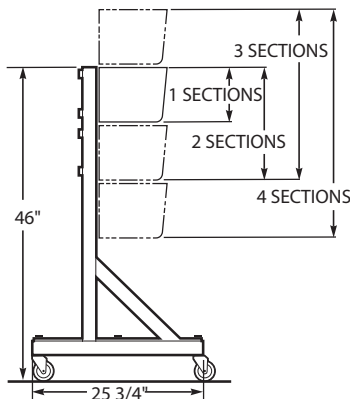

Universal Floor Stand

The Universal Floor Stand will accommodate all 15 or 30 amp

Mainframes from one to four sections high. Stand is made from heavy gauge steel and includes locking casters (400 lb. rating).

All assembly and Mainframe mounting hardware is included. Heavy duty floor stand available for larger systems (1000 lb. rating).

ITEM NUMBER	RATING
MFS512G	400 LBS

Floor stand comes with plates for 5-zone frame mounting on 8-zone "x" pattern

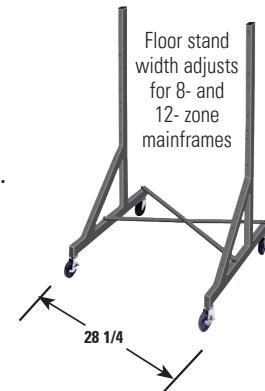



Temperature Controllers

Standard Mainframe Configurations

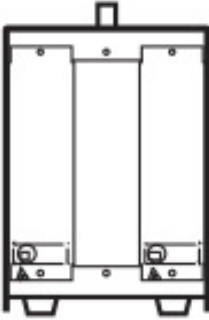

MF1

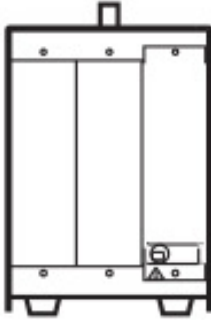

MF2

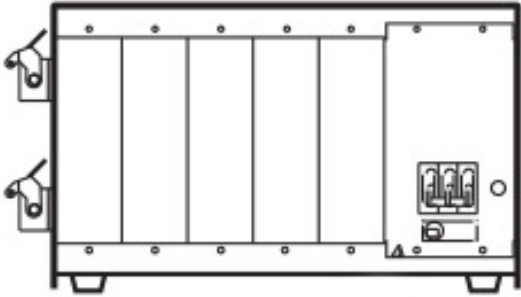

MF5150

50 AMP

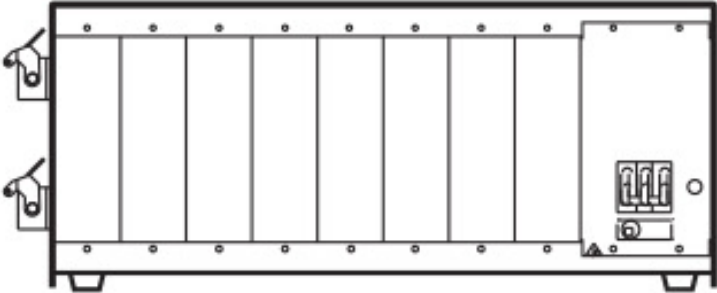

MF8150

50 AMP

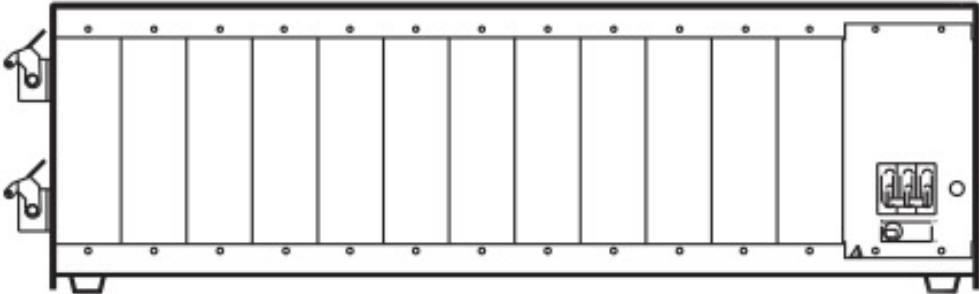

MF12150

50 AMP

Temperature Controllers

Control System Components



MAINFRAMES, CABLES & CONNECTORS ALL SOLD SEPERATELY

	PART NUMBER	DESCRIPTION
	UATC20	Module, Single Zone Temperature Controller, Dual Display
1 ZONE	MF1	1-Zone Mainframe; Standard 1-phase 3 Wire, 208-240 VAC, 10 Amps
	MPTC10	1-Zone Mold Power Cable; 10' O.A.L.
	MPTC20	1-Zone Mold Power Cable; 20' O.A.L.
	CKPTIC1	1-Zone Mold Power Input Connector
2 ZONE	MF2	2 -Zone Mainframe; Standard 1-phase 3 Wire, 208-240 VAC, 10 Amps
	MPTC10	1-Zone Mold Power Cable; 10' O.A.L. (2 required)
	MPTC20	1-Zone Mold Power Cable; 20' O.A.L. (2 required)
	CKPTIC1	1-Zone Mold Power Input Connector (2 required)
5 ZONE	MF5150	5-Zone Mainframe; Standard 3-phase 4 Wire, 208-240 VAC, 15 Amps
	MPC5C10G	5-Zone Mold Power Cable; 10' O.A.L.
	MPC5C20G	5-Zone Mold Power Cable; 20' O.A.L.
	MPC5C30G	5-Zone Mold Power Cable; 30' O.A.L.
	TC5C10G	5-Zone Thermocouple Cable; 10' O.A.L.
	TC5C20G	5-Zone Thermocouple Cable; 20' O.A.L.
	TC5C30G	5-Zone Thermocouple Cable; 30' O.A.L.
	PIC5G	5-Zone Mold Power Input Connector
MTC5G	5-Zone Mold Thermocouple Connector	
8 ZONE	MF8150	8-Zone Mainframe; Standard 3-Phase 4 Wire, 208-240 VAC, 15 Amps
	MPC8C10G	8-Zone Mold Power Cable; 10' O.A.L.
	MPC8C20G	8-Zone Mold Power Cable; 20' O.A.L.
	MPC8C30G	8-Zone Mold Power Cable; 30' O.A.L.
	TC8C10G	8-Zone Thermocouple Cable; 10' O.A.L.
	TC8C20G	8-Zone Thermocouple Cable; 20' O.A.L.
	TC8C30G	8-Zone Thermocouple Cable; 30' O.A.L.
	PIC8G	8-Zone Mold Power Input Connector
MTC8G	8-Zone Mold Thermocouple Connector	
12 ZONE	MF12150	12-Zone Mainframe; Standard 3-Phase 4 Wire, 208-240 VAC, 15 Amps
	MPC12C10G	12-Zone Mold Power Cable; 10' O.A.L.
	MPC12C20G	12-Zone Mold Power Cable; 20' O.A.L.
	MPC12C30G	12-Zone Mold Power Cable; 30' O.A.L.
	TC12C10G	12-Zone Thermocouple Cable; 10' O.A.L.
	TC12C20G	12-Zone Thermocouple Cable; 20' O.A.L.
	TC12C30G	12-Zone Thermocouple Cable; 30' O.A.L.
	PIC12G	12-Zone Mold Power Input Connector
MTC12G	12-Zone Mold Thermocouple Connector	





Temperature Controllers

Accessories



Universal Mainframe Floorstand.

Stand accommodates from one to four mainframes. Kit includes the uprights, casters and hardware.

Part# MFS512G & MFS512GHD



Mainframe Blank Panels

Blank panels cover unused mainframe zones to protect operators from dangerous high voltage.

Part# MFBP30G & MFBP10G

Module Replacement Fuses		
Part Number	AMPS	Qty.
ABC1	1	5
ABC10	10	5
ABC15	15	5
13X10	10	5
13X15	15	5

FUSES

Temperature Controllers

Cables

Part Number		Part Number		Part Number	
Zones	(10' Length)	Zones	(15' Length)	Zones	(20' Length)
Mold Power Cable					
5	MPC5C10G	5	GMPC5-15	5	MPC5C20G
8	MPC8C10G	8	GMPC8-15	8	MPC8C20G
12	MPC12C10G	12	GMPC12-15	12	MPC12C20G
Thermocouple Cable					
5	TC5C10G	5	GTC5-15	5	TC5C20G
8	TC8C10G	8	GTC8-15	8	TC8C20G
12	TC12C10G	12	GTC12-15	12	TC12C20G



Temperature Controllers

Connectors

Zones	Part Number
Mold Power Input Connectors	
5	PIC5G
8	PIC8G
12	PIC12G
Mold Thermocouple Connectors	
5	MTC5G
8	MTC8G
12	MTC12G



Temperature Controllers



Mold Connectors, Terminal Boxes and Connector Kits

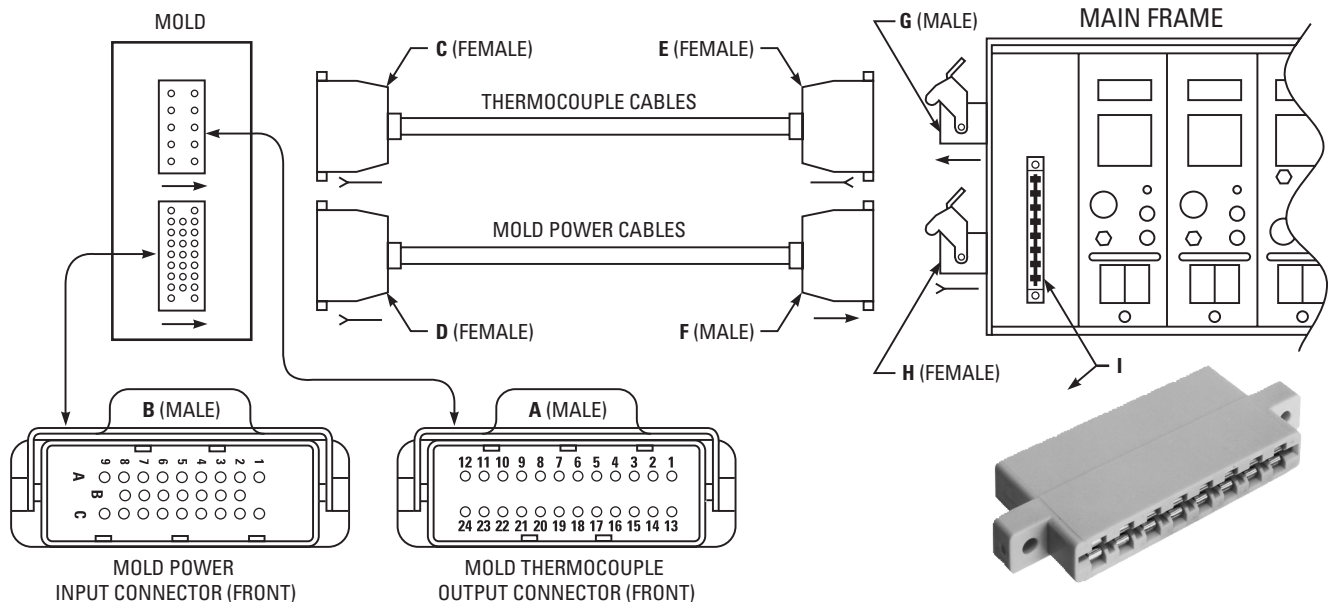

Connectors/Connector Kits (5 – 48 Zone, 15 AMP; 2 – 5 Zone, 30 AMP)

Reference Letter	Description	Part Number
A	Mold Thermocouple Output Connectors	MTC5G MTC8G MTC12G
B	Mold Power Input Connectors	PIC5G PIC8G PIC12G
C	Mold End Kit for 5-Zone Thermocouple Cable (10, 15 or 30 AMP)	CKTF15G
	Mold End Kit for 8-Zone Thermocouple Cable (10 or 15 AMP)	CKTF18G
	Mold End Kit for 12-Zone Thermocouple Cable (10 or 15 AMP)	CKTF112G
D	Mold End Kit for all 10 or 15 AMP Power Cables	CKPF112BG
	Mold End Kit for 2- or 3-Zone 30 AMP Power Cables	CKPF13CG
	Mold End Kit for 5-Zone 30 AMP Power Cables	CKPF15CG
E	Frame End Kit for all Thermocouple Cables (10, 15 or 30 AMP)	CKTF112AG
F	Frame End Kit for all 10 or 15 AMP Power Cables	CKPM112BG
	Frame End Kit for 2- or 3-Zone, 30 AMP Power Cables	CKPM13CG
	Frame End Kit for 5-Zone, 30 AMP Power Cables	CKPM15CG
G	Thermocouple Input Kit for all Mainframes (10, 15 or 30 AMP)	CKTM212AG
H	Power Output Kit for all 10 or 15 AMP Mainframes	CKPF212BG
	Power Output Kit for 2- or 3-Zone, 30 AMP Mainframes	CKPF23CG
	Power Output Kit for 5-Zone, 30 AMP Mainframes	CKPF25CG
I	Edge Card Connector Kit for all Mainframe PC Boards (10, 15 or 30 AMP)	CKF312G



Temperature Controllers

Terminal Box Detail and Mold Connectors

Terminal Mounting Boxes

Terminal Mounting Boxes provide the easiest and most economical method of mounting power and thermocouple connectors on the mold. Constructed of plated, heavy-gauge steel, each box is pre-cut and drilled for quick mounting of the connector to the box, and box to the mold. Connector mounting hardware is supplied. Connectors are ordered separately.

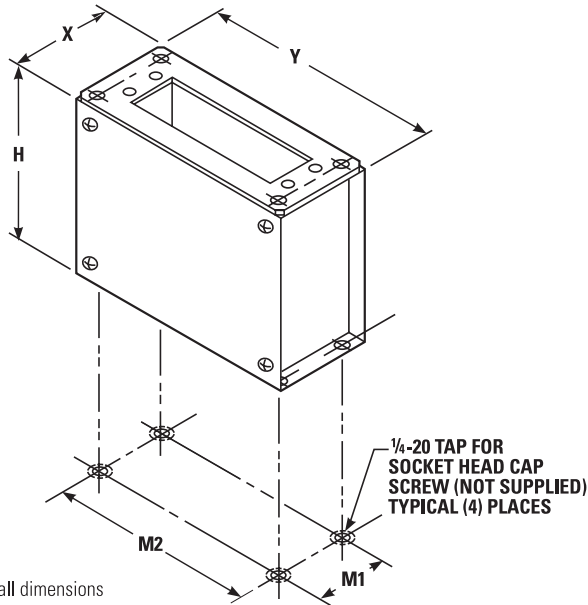

NOTE: Overall dimensions shown include allowances for hardware (assembly screws) but not connectors.

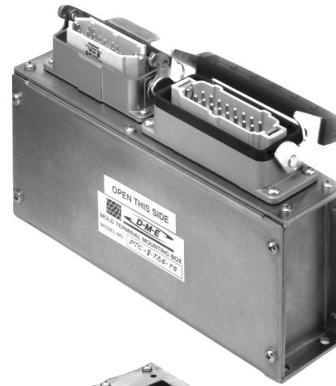

PTC8TBG
(Connectors ordered separately)

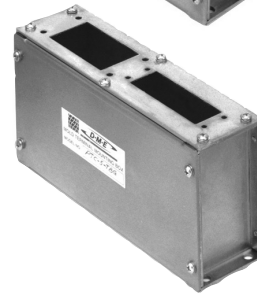

PTC5TBG



PTC0012



PTC210



PIC512TBG

Terminal Mounting Boxes for Mold Power Input Connectors **TERMINAL**

Part Number	X	Y	H	M1	M2	Accepts
PIC512TBG	2.75	4.875	4.25	1.500	4.250	PIC5, 8 or 12G
PICH23TBG	2.75	5.614	4.25	1.500	4.990	PICH23G
PICH5TBG	4.46	6.676	4.25	3.250	6.052	PICH5G

Terminal Mounting Boxes for Thermocouple Connectors **TERMINAL**

Part Number	X	Y	H	M1	M2	Accepts
MTC5TBG	2.75	4.875	4.25	1.500	4.250	MTC5G
MTC8TBG	2.75	5.614	4.25	1.500	4.990	MTC8G
MTC12TBG	2.75	6.676	4.25	1.500	6.052	MTC12G

Combination Terminal Mounting Boxes

COMBINATION

Part Number	X	Y	H	M1	M2	Accepts
PTC210	2.75	4.88	4.25	1.500	4.250	(2) CKPTIC1
PTC5TBG	2.75	8.66	4.25	1.500	8.031	PIC5G, MTC5G
PTC8TBG	2.75	9.47	4.25	1.500	8.843	PIC8G, MTC8G
PTC12TBG	2.75	10.53	4.25	1.500	9.906	PIC12G, MTC12G
PTCH1TBG**	4.46	4.88	4.25	3.250	4.250	AC1240MI, TCS1
PTCH23TBG	2.75	10.53	4.25	1.500	9.906	PICH23G, MTC5G
PTCH5TBG	4.46	11.06	4.25	3.250	10.431	PICH5G, MTC5G
PTC0012	4.46	7.66	4.25	3.250	7.160	TPC0001

* Used with 2-zone, 15 AMP mainframe MFFPR2G ** Used with 1-zone, 30 AMP mainframe MFHP1G

Temperature Controllers



Standalone Integral Controller

Single and Two-Zone 10 AMP Mainframes

The DME Portable 10 AMP Mainframes are designed for use with 10 or 15 AMP* Smart Series or G-Series Temperature Control Modules. Mainframe is supplied with power input and power-thermocouple output connectors. Circuit breaker provides safety for operation. Control modules and cables are to be ordered separately.

Note: Maximum safe operating amperage is 10 AMPS per zone when using 15 AMP modules. If application will draw more than 10 AMPS per zone, use 15 AMP Mainframe (MFFPR2G).

* User must install ABC10 (10 AMP) fuses in the 15 AMP control modules to protect the mainframe.

Single and Two-Zone 10 AMP Mainframes (50–60 Hz, Single Phase)

Zones	Part Numbers**	Volts	Watts Per Zone	Connectors Supplied
1	MFP1G1	120	1200	(1) AC1512F (Power In) (1) CKPTM1 (Power-TC Out)
1	MFP1G	240	2400	(1) AC2024F (Power In) (1) CKPTM1 (Power-TC Out)
2	MFPR2G	240	2400	(1) AC2024F (Power In) (2) CKPTM1 (Power-TC Out)

** Includes frame and connectors listed. Modules and cables ordered separately.

Note: Replacement power connectors in frame are also available on special order.

Recommended Mold Pocket Layout

(For Mold Power-Thermocouple Input Connector CKPTIC1)

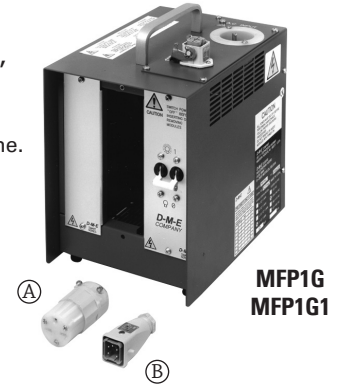
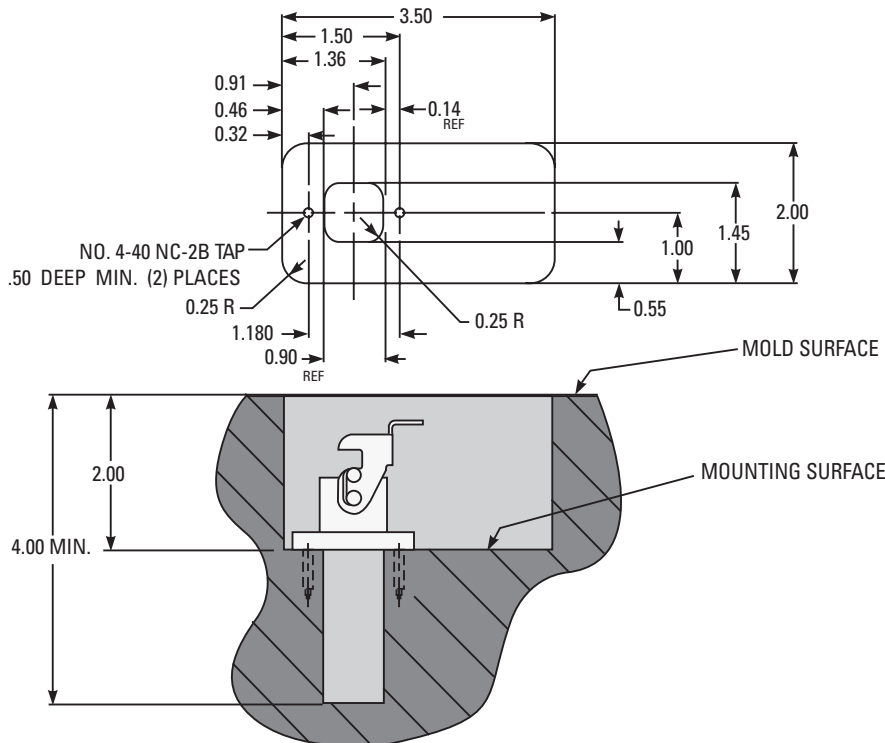

A: AC2024F (power to mainframe); AC1512F supplied with MFP1G1
B: CKPTM1 (connector to heater)

This single-zone controller is ideal for use with Straight-Shot hot sprue bushings.



A: AC2024F (power to mainframe);
B: CKPTM1 (connector to heater)

Single zone, horizontal 10 AMP controllers (SSH1022/21) also available following page.

Dimensions
Frame 7"W x 9"H x 10"D
(9"H dimension does not include connectors or handle)



Temperature Controllers

RoHS/WEEE Compliant Smart Series® Single Zone Temperature Controller

SSH1022/21 (10 AMP)

- Compact
- Easy-to-use
- Includes new, improved and unique features
- Provides microprocessor-based PID control
- More accurate than analog or variac controllers
- Built-in thermocouple diagnostics
- Ideal for use with a hot sprue bushing or a machine nozzle

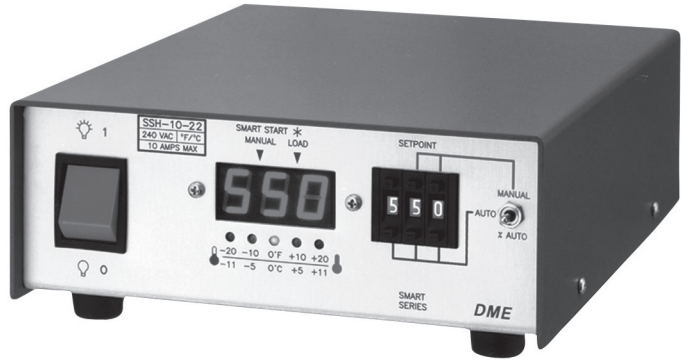

Key Features

- Large digital display
 - For easier readability of temperature, % power and faults
- Setpoint pushwheel
 - For setting desired setpoint temperature
 - Allows adjustment of setpoint before turning power on
- AUTO % power display
 - Shows % power output while in AUTO mode
 - Indicates average % power requirement on thermocouple failure
 - A diagnostic tool for solving problems

Switchable Options

- Shorted thermocouple sensitivity adjustment
 - Operation can be tailored to fast or slow reaction times
 - Sensitivity can be adjusted with internal switches
 - Very useful for zones with long startup times
- Switchable °C/°F operation
 - Scale indicated at startup
- K type thermocouple support
- Cut feature
 - Gain cut feature for small nozzles and heaters with ungrounded internal thermocouples

Operational Refinements

- Improved SmartStart®
 - A more gradual temperature rise leads to a more effective heater dry out period, thereby extending heater life
 - SmartStart® now available as an option in manual mode
- SelectiveCycle®
 - A very high-speed power output approach
 - Enables accurate temperature control and longer heater life
- Bumpless transfer
 - When a thermocouple failure occurs, operation is automatically continued with a learned % power
 - Unique software accurately assigns percent power setting
- Third fuse
 - Allows for display of low temperature alarm when the load fuses are blown

Front Panel Digital LED Indicators

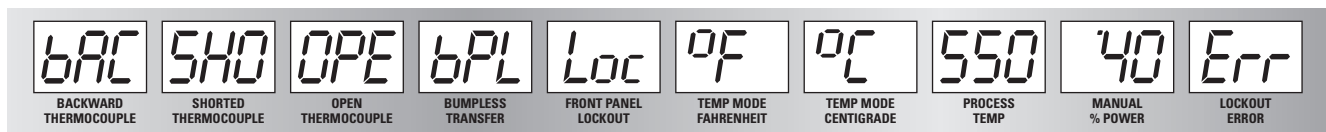

Temperature Controllers



RoHS/WEEE Compliant Smart Series® Single Zone Temperature Controller

SSH1022/21 (10 AMP)

Controller includes 19-foot power cord, mating mold power and thermocouple connector (CKPTM1) and two spare fuses (ABC10). Additional cables and/or connectors must be ordered separately. See following page for detailed information on cables and connectors. Warranty: Three year (excluding triac and fuses).

Controller Part Number	Volts (VAC)
SSH1022	240
SSH1021	120

Cable* Part Number	Length (Feet)
MPTC10	10
MPTC20	20

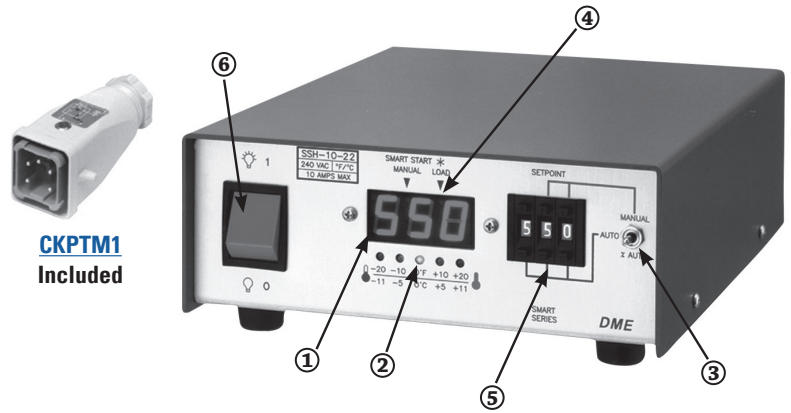

Front Panel Controls and Indicators

- Process Temperature Display:**
Shows process temperature, thermocouple faults and other operational modes. Displays % power when switch (3) is pressed down.
- Temperature Deviation Lights:**
Indicates deviation from setpoint. Outer lights blink at more than $\pm 40^{\circ}\text{F}$ (22°C) from setpoint.
- Auto/Manual/% Auto Power Switch:**
Selects AUTO or MANUAL control mode. Shows % power when pressed into "% AUTO" position.
- LED Mode Indicators:**
Left LED illuminates during manual mode. Right LED illuminates when power is supplied to heater. Right LED blinks during SmartStart®.
- Setpoint Pushwheel:**
Three-digit switch programs setpoint in AUTO mode. Right two digits program % power in MANUAL mode.
- Power On/Off Switch:**
Controls AC power to module.



Mold Power and Thermocouple Connector* Part Number
CKPTIC1

F

Rear Panel

- Mold Power and Thermocouple Output Connector:**
CKPTIC1 connects to the heater and thermocouple. Mating connector CKPTM1 is supplied with controller.
- Power Input Cord:**
Nineteen-foot cord supplies power to controller. Plug supplied with SSH1021 (120 VAC) units. No plug supplied with SSH1022.
- Load Fuse Receptacles:**
Provides safe and easy replacement of load fuses.

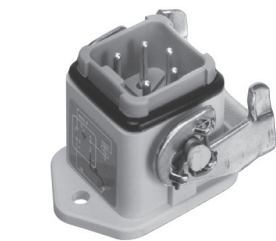

* Items ordered separately

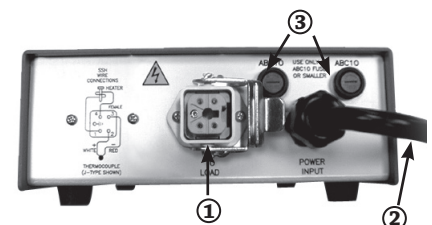



Temperature Controllers

RoHS/WEEE Compliant: Smart Series® Single and 2-Zone Mainframe Accessories (10 AMP)

For Use With MFP1G, MFP1G1, MFPR2G, SSH1022 and SSH1021

Mold Power-Thermocouple Input Connector

A Single-Zone Power-Thermocouple Input Connector is available for mounting in or on the mold to accept the power-thermocouple cable from the mainframe. Water resistant, the connector has an integral retaining latch for a secure cable connection and numbered screw-type terminals for power and thermocouple lead wires.

*Can be mounted on top of mold for use with DME Straight Shot hot sprue bushings.



Part Number
MPTC10
MPTC20

Armored Mold Power-Thermocouple Cables

Single-Zone Mold Power-Thermocouple Cables are constructed of special lead wire for use in high temperature environments, and are available to connect the mainframe to the connector on the mold. Available in lengths of 10 or 20 feet. Integral retaining latches on the mainframe and mold connections provide secure cable connections. Connector configurations ensure proper insertion of cable.

Replacement Connector Kits (for Controller & Cables)

Male Power-TC Connectors

- CKPTM1 is on MPTC10/20 Cables; mates with Frame or CKPTF1L only
- CKPTM1L mates with CKPTF1 only

Female Power-TC Connectors

- CKPTF1 is on MPTC10/20 Cables; mates with Mold or CKPTM1L only
- CKPTF1L mates with CKPTM1 only

AC1512F



CKPTM1



CKPTF1



PTC210



AC2024F



CKPTM1L

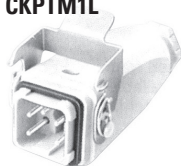

CKPTF1L



Power Input Connectors for Mainframe

Part Number	Volts
AC1512F	120
AC2024F	240

Part Number
CKPTM1
CKPTM1L
CKPTM1MH (metal hood)
CKPTM1LMH (metal hood)

Part Number
CKPTF1
CKPTF1L
CKPTF1MH (metal hood)
CKPTF1LMH (metal hood)

Part Number
PTC210

Wiring Diagrams

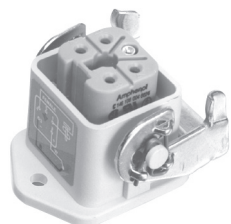

Part Number
[CKPTOC1](#)

Power-Thermocouple Output Connector
(for Mainframe Bulkhead)

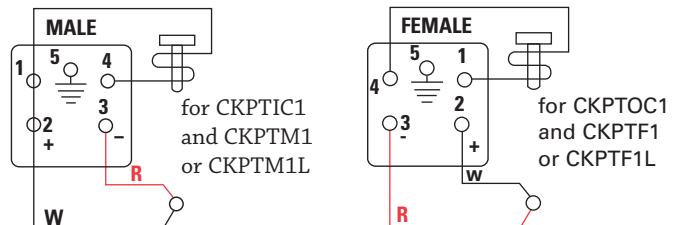

Temperature Controllers



RoHS/WEEE Compliant: Smart Series® Single and 2-Zone Mainframe Accessories (10 AMP)

Two-Zone 15 AMP Mainframes

Provides 15 AMP (3600 watts) per zone. For use with Smart Series or G-Series modules. Supplied with built-in cooling fan, power input, power output and thermocouple input connectors. Control modules and cables are ordered separately.



Two-Zone 15 AMP Mainframe (240 VAC, 50–60 Hz, Single Phase)

Part Number	Watts Per Zone	Connectors Supplied
MFFPR2G	3600	(1) AC1240F (Power In) (2) AC1524M (Power Out) (3) M2MJ (TC In)

Includes frame and connectors listed. Modules and cables ordered separately.

Part Number	Description
AC1240F*	Female 240 VAC twist-lock power input connector (mates with male frame power input)
AC1524M*	Male 240 VAC power output connector (mates with female frame power outputs)
M2MJ.*	Thermocouple mini-plug mates with frame as jack strip connector
PTC2TBGTS	2 zone, pre-wired terminal mounting box with terminal strip (mounts to mold; mates with PTC0110 or PTC0120 cables)

* Included with MFFPR2G

Frame Dimensions

7"W × 9"H × 10"D
(9"H dimension does not include connectors or handle)

Armored Mold Power – Thermocouple Cables (15 AMP)

Single-Zone Mold Power-Thermocouple Cable is constructed of special lead wire for use in high temperature environments. This cable connects the mainframe to the connector on the mold. Available in lengths of 10 or 20 feet. Retaining latches on the mold connector provide secure cable connections.



Part Number
PTC0110
PTC0120

For use with MFFPR2G only

Terminal Mounting Boxes – Prewired (15 AMP)

Terminal Mounting Boxes provide the easiest and most economical method of mounting power and thermocouple connectors on the mold. Constructed of plated, heavy-gauge steel, each box is pre-cut and drilled for quick mounting of the box to the mold (2-zone, prewired terminal mounting box with terminal strip shown with cover plate removed).

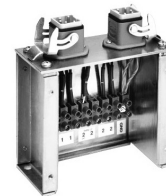

Part Number
PTC2TBGTS

For use with MFFPR2G only



Part	Part Number
6 Contacts, HBE Series	
Male Plug	10.1900
Receptacle	10.1910
Single Latch	
Panel Base	RPM0060
Surface Base	10.0050
Top Hood	RPM0060
Side Hood	10.0120
6 Contacts, H-BS Series	
Male Plug	10.1700
Receptacle	10.1710
Single Latch	
Panel Base	RPM0060
Surface Base	10.0749
Top Hood	RPM0069
Side Hood	10.0829
Double Latch	
Panel Base	10.0720
Surface Base	10.0740
Top Hood	10.0800
Side Hood	10.0820
10 Contacts, HBE Series	
Male Plug	RPM0062
Receptacle	RPM0065
Single Latch	
Panel Base	RPM0059
Surface Base	10.0349
Top Hood	RPM0068
Side Hood	10.0429
Double Latch	
Panel Base	10.0320
Surface Base	10.0340
Top Hood	10.0400
Side Hood	10.0420
10 Contacts, HA Series	
Male Plug	10.4400
Receptacle	10.4410
Single Latch	
Panel Base	10.4420
Surface Base	10.4481
Top Hood	10.4460
Side Hood	10.4450

Part	Part Number
12 Contacts, H-BS Series	
Male Plug	10.1820
Receptacle	10.1830
Double Latch	
Panel Base	10.1320
Surface Base	10.1370
Top Hood	10.1330
Side Hood	10.1350
16 Contacts, H-BE Series	
Male Plug	RPM0063
Receptacle	RPM0066
Single Latch	
Panel Base	RPM0060
Surface Base	10.0749
Top Hood	RPM0069
Side Hood	10.0829
Double Latch	
Panel Base	10.0720
Surface Base	10.0740
Top Hood	10.0800
Side Hood	10.0820
24 Contacts, H-BE Series	
Male Plug	RPM0064
Receptacle	RPM0067
Single Latch	
Panel Base	RPM0061
Surface Base	10.1049
Top Hood	RPM0070
Side Hood	10.1139
Double Latch	
Panel Base	10.1020
Surface Base	10.1040
Top Hood	10.1210
Side Hood	10.1130
25 Contacts, H-D Series	
Male Plug	RPM0072
Receptacle	RPM0073
Single Latch	
Panel Base	RPM0074
Surface Base	10.5670
Top Hood	10.5650
Side Hood	10.5640

Male Plugs and Female Receptacles

- With screw terminals: 3 to 48 captive, backed-off screws for easy and convenient wire termination
- With crimped terminals 7 to 216 contacts
- Contacts are hard, silver-plated copper alloy. (Gold plating available in crimp versions.)
- Ground-safety feature “makes first, breaks last.”
- Insulators are interchangeable within either base or hood, and are key-molded to ensure proper assembly
- Terminals are number coded, front and back, for easy installation

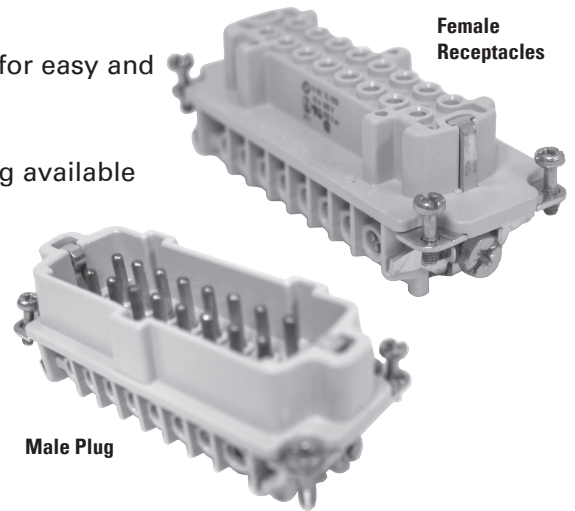

Female Receptacles

Male Plug

Hood

- Built to withstand severe environmental and industrial hazards
- Provides protection against dirt, grease, oil, water, vibration and impact
- Durable, rugged, single-piece aluminum die casting
- Designed for flexible cable; adaptable for seal-tight connections
- Available with front, angled or top entry
- Fully adaptable - a multi-cut Neoprene gasket provides for cables of different sizes

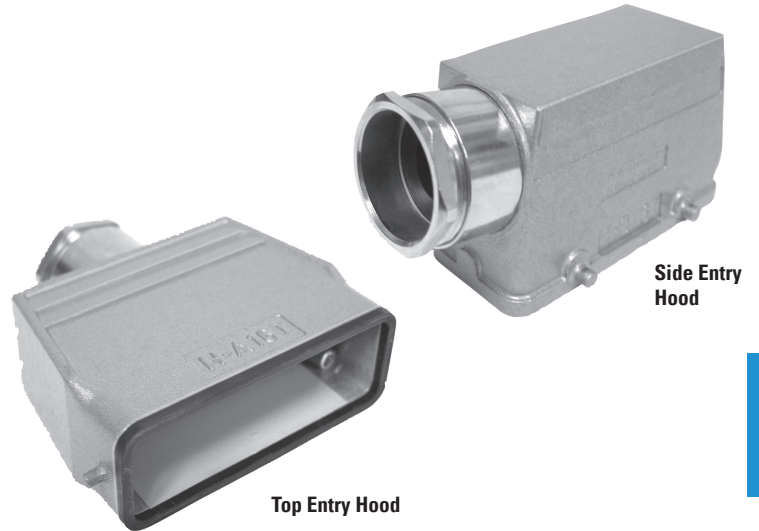

Side Entry Hood

Top Entry Hood

Base

- Positive, spring-loaded locking-latches for quick connect and disconnect
- Designed with a lip-mounted Neoprene gasket for long protection against harsh environments
- Available in panel-mount base and single or double-entry, surface-mount base versions
- Available with spring-loaded or string-attached dust covers

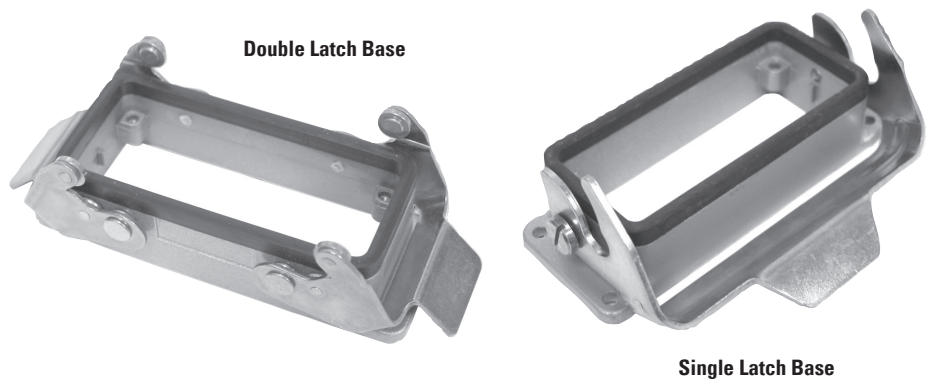

Double Latch Base

Single Latch Base





Digital Pocket Thermometer

Wide Range
40° to 450°F

Updates: At 10 second intervals
or instantly when button is pushed

Display: LCD, 1/4" high

Stem: Stainless steel

Range: -40° to 450°F

Resolution: 0.1°F

Accuracy: 0.4% of total range between -4° and
77°F; 0.8% maximum over entire range

Maximum Temperature: Intermittent use 400°-
450°F

Update Interval: 10 sec (or instant when update
button pressed)

Auto-Off: After 50 minutes of non-use

Battery: Eveready #392 or equivalent

Minimum Insertion: 1 inch

Part Number D-450

Analog Pocket Thermometer

Part Number	Temp. Range
K795	50 to 550°F



Dial Thermometers



Standard Ranges: Fahrenheit

Range	0-200°	*0-250°	*50-300°	*50-500°	150-750°	200-1000°
Divisions	2°	2°	2°	5°	10°	10°

*Stock Range

Standard Ranges: Celsius

Range	0-100°	*0-150°	0-300°	Range	50-300°F/ 10-150°C.	50-500°F/ 10-260°C.
Divisions	1°	1°	2°	Divisions	2°	5°

Dual Ranges

1/8", 1/4" or 1/2" NPT Stem
Diameter Industrial
Thermometers

- Type 304 stainless steel
- All welded construction
- Easy to read
- Rustproof
- Dustproof
- Leakproof
- Corrosion resistant
- Accuracy to ± 1% of range
- Dampened for minimum vibration
- Perfect for hopper dryers, barrels, fluid heaters, etc.

Model Number	LN250	212	00200
NPT Stem			
1/8" NPT and 2-3/8" Head Dia	LN200		
1/4" NPT and 2-3/8" Head Dia	LN250		
1/2" NPT and 3" Head Dia	GT300		
	Stem Length		
	2-1/2"	212	
	4"	400	
	6"	600	
	9"	900	
	12"	1200	
	15"	1500	
	18"	1800	
Temperature Range °F			
	0-200		00200
	0-250		00250
	50-300		50300
	50-500		50500
	150-750		150750
	200-1000		2001000



DIAL THERMOMETERS





Non-Contact Thermometers

Wide Range Mini IR Thermometer

Compact Thermometer with Wide Temperature Range

- Measures temperature from -58 to 1000°F with 0.1° resolution up to 199.9°
- Built-in laser pointer identifies target area
- 2000 count backlit display
- Over range indicator
- Automatic data hold when trigger is released
- Fixed 0.95 emissivity covers 90% of surface applications
- Auto power off saves battery life
- Complete with 9V battery



Part Number 42510

Specifications	
Display Counts	2000 count backlit LCD
Basic Accuracy	±2% of reading
Field of View	8:1
Dimensions	3.2 x 1.6 x 6.3" (82 x 42 x 160 mm)
Weight	6.4 oz (180g)

Non-Contact Thermometers

Wide Range IR Thermometer with Type K Input

Measures Both Non-Contact and Contact Temperature Plus Stores 20 Readings

- Wide temperature range IR temperature and type K thermocouple measurements
- Automatic emissivity adjustment (for temperatures 212°F or higher)
- Memory stores up to 20 readings
- Large LCD display with bright backlight for easy-to-read measurements and programming parameters
- Laser pointer provides better aim and accuracy
- Auto-hold activates when the measurement trigger is released
- Adjustable high/low alarm alerts user visually and audibly when temperature exceeds programmed limits
- MAX/MIN/AVG/DIF features display highest, lowest, average, and MAX minus MIN values
- Data hold, auto power off, and low battery indication
- Switches built into handle allow for °C/°F display selection, auto power off defeat, and alarm on/off control
- Complete with 9V battery, type K thermocouple sensor (-4 to 482°F/-20 to 250°C), and carrying case



Part Number 42515

Specifications	
Display Counts	4000 count backlit LCD
Range	IR: -58 to 1472°F (-50 to 800°C) Type K: -58 to 2498°F (-50 to 1370°C)
Basic Accuracy	IR: (±2% of reading or 4°F/2°C) whichever is greater < 932°F/500°C ± (2.5% rdg +5°) > 932°F/500°C Type K: (±1.5% Reading + 5° For 3°C)
Max Resolution	0.1°F/°C
Emissivity	Adjustable 0.10 to 1.00
Field of View	13:1 distance to target ratio
Dimensions	3.2 x 1.6 x 6.3" (82 x 42 x 160 mm)
Weight	6.4 oz (180g)

NOTE: The included type K temperature probe plugs into bottom of handle when in use.

Type K Thermometers with single or dual input direct or differential measurements to 0.1°

Features

- Rugged design for field use - includes rubber holster
- Dual input model provides differential readings
- Accurate to 0.3%, C°/F° switchable
- Front panel offset adjustment to optimize accuracy
- Displays maximum reading plus data hold on large LCD display
- Includes (6) AAA batteries, holster with stand, and temperature probe



EXTECH
INSTRUMENTS

Single Input – Part Number EA11

Dual Input – Part Number EA10

Specifications	Ranges	Accuracy
Temperature	-50 to 1300°C	(0.3% rdg + 1°C); >1000°C (0.5%)
	-58 to 2000°F	(0.3% rdg + 2°F)
Resolution	0.1° or 1°	
Dimensions	5.2 x 2 x 2.8 x 1.2" (135 x 72 x 31mm)/6 x 2.8 x 1.5" (152 x 72 x 37mm)	
Weight	8.3 oz. (235g)	

Principles of Thermocouples & Thermocouple selection

General Information

Thermocouples are the most widely used devices to measure temperature in the injection molding industry. They consist of a welded (hot) junction, between two lead wires of dissimilar metals (usually iron and constantan, Type J) and a reference junction at the other end of the lead wires. The hot junction creates an electrical current which can be measured at the reference junction. This measurement corresponds to a specific temperature, which provides output reading or control switching. Advantages of using thermocouples include the ability to measure a wide temperature range, durability at high temperature, fast response time, and low cost.

Junctions

Grounded – In grounded thermocouples, the conductors are contained in a stainless steel sheath. The hot junction is welded to the end of the sheath (see diagram 1). This provides high durability and environmental protection without sacrificing response time. The disadvantage of this construction is that there is no electrical protection from voltage surges coming into contact with the sheath. Grounded construction is the most common thermocouple type used in the plastics industry. Most DME thermocouples are grounded. Insulated thermocouples are available on request.

Ungrounded (Insulated): In ungrounded construction the hot junction is insulated from the sheath within mineral insulating compound (see diagram 2). This provides complete isolation from any stray voltage that may be present in the application. The drawback with this construction is increased response time due to increased time for heat to penetrate the insulation and reach the hot junction.

Exposed – The conductors extend beyond the sheath (see diagram 3), providing very rapid response time, but no protection from the environment or stray voltages. Exposed thermocouples are fragile.

Fig. 1

 **Grounded**
Hot junction welded to sheath tip. Earthed output provides fast response time.

Fig. 2

 **Insulated**
Hot junction insulated from sheath. Insulation resistance over 100 Megohms.

Fig. 3

 **Exposed**
Hot junction extends beyond sheath.

Calibration (Type)

Thermocouples are made of two dissimilar metals with specific electrical characteristics. The specific metals used determine the type of thermocouple. Most thermocouples used in the U.S. plastics industry are Type J (iron/constantan). Less commonly used is Type K (chromel/alumel). Check your machine or temperature control to determine which type you need. If you are unsure, determine the type from the wire color coding in the table

ISA Code	Conductor Characteristics		Temperature Range (°F)	Limits of Error		Application Notes
	Positive	Negative		Standard	Special	
J	Iron (magnetic)	Constantan (non-magnetic)	0 to 530	±4.0°F	±2.0°F	Reducing atmosphere recommended
			530 to 1400	±0.75%	±0.38%	
K	Chromel (non-magnetic)	Alumel (magnetic)	0 to 530	±4.0°F	±2.0°F	Oxidizing atmosphere recommended
			530 to 2300	±0.75%	±0.38%	
T	Copper	Constantan	-75 to 200	±1.8°F	±0.9°F	Can be used in oxidizing or reducing atmosphere; Corrosion resistant
			200 to 700	±0.75%	±0.38%	
E	Chromel	Constantan	0 to 600	±3.0°F	±1.8°F	Oxidizing atmosphere recommended; highest EMF output
			600 to 1600	±0.5%	±0.38%	

Thermocouple and Extension Wire Color Codes

U.S. ANSI/ASTM Code	U.S. ANSI/ASTM TC	U.S. ANSI/ASTM Extension	U.K. BS 1843	Germany DIN 43710	Japan JIS C1610-1981	Europe IEC 584-3
Type J Pos. Magnetic						
	Type K Neg. Magnetic					

Standard Thermocouples

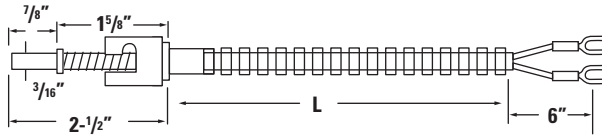

STANDARD



Straight model TCJ

Standard Thermocouples have a variable immersion depth of 1 1/4" to 1 3/4" with a probe mounting length of 2 1/2". Featuring heavy-duty armor covered leads with standard wire lug lead termination and a 3/16" probe diameter, they will accommodate most requirements in either a straight or 90° bend. Off-the-shelf delivery and a very low price make our standard thermocouples just what you need. Also available in K & RTD types.

Standard Thermocouple

Part Number	Lead Length	End
TCJ1048	48"	Straight
TCJ1060	60"	Straight
TCJ1072	72"	Straight
TCJ1120	120"	Straight

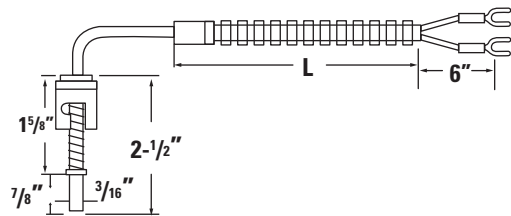

90-degree bend model TCJ9

Standard Thermocouple - 90°

Part Number	Lead Length	End
TCJ9-1048	48"	90°
TCJ9-1060	60"	90°
TCJ9-1072	72"	90°
TCJ9-1120	120"	90°

Shallow Nozzle Thermocouples

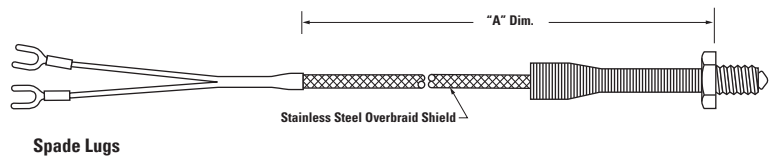

Shallow nozzle thermocouples are available in J or K type and 3 thread sizes. Our 1/2" swivel will seat in shorter holes but also provide accurate readings in deep holes.

Shallow Nozzle Type Thermocouples

Metrics Fit Nissei, Kawaguchi and Others

Part Number	TC Type	Thread Size	(A) Lead Length
NTJ-48	J	1/4-28 N.F.	48"
NTJ-72	J	1/4-28 N.F.	72"
NTJ-48M6	J	M6 x 1 Metric	48"
NTJ-72M6	J	M6 x 1 Metric	72"
NTJ-48M8	J	M8 x 1 Metric	48"
NTJ-72M8	J	M8 x 1 Metric	72"
NTK-48	K	1/4-28 N.F.	48"
NTK-72	K	1/4-28 N.F.	72"
NTK-48M6	K	M6 x 1 Metric	48"
NTK-72M6	K	M6 x 1 Metric	72"
NTK-48M8	K	M8 x 1 Metric	48"
NTK-72M8	K	M8 x 1 Metric	72"

SHALLOW NOZZLE



Hi-Temp. Thermocouples

Style "MMT" Miniature Molded Transition

Sensor accuracy and reliability are essential to the precise control of temperatures in multi-component industrial processing systems. Our mineral-insulated style "MMT" thermocouples feature a high-temperature, molded thermoset lead transition. The durable and cost-effective molded transition provides heat and moisture resistance for demanding applications. These high-quality thermocouples are manufactured to stringent specifications and have gained a reputation for unsurpassed performance and reliability. All alloys used in the cable and leads meet or exceed the ANSI specifications for thermocouple grade wire. A full range of lead insulation materials allows selection of leads based on application requirements.

The precision-welded element and lead connections are totally encapsulated in a high-temperature molded thermoset material. If very durable, small diameter thermocouple transitions are required the style "MSMT" thermocouples which are molded into a protective stainless steel cover should be considered. The molded transition provides the highest level of moisture resistance. The standard molded thermoset transition is rated at 800°F. These thermocouples can be readily installed into small diameter thermowells, drilled holes or grooves. When required, tabs, rings and other fastening devices can be induction brazed to the cable to simplify their attachment tool surfaces.

Style "MMT" Miniature Molded Transition Thermocouples

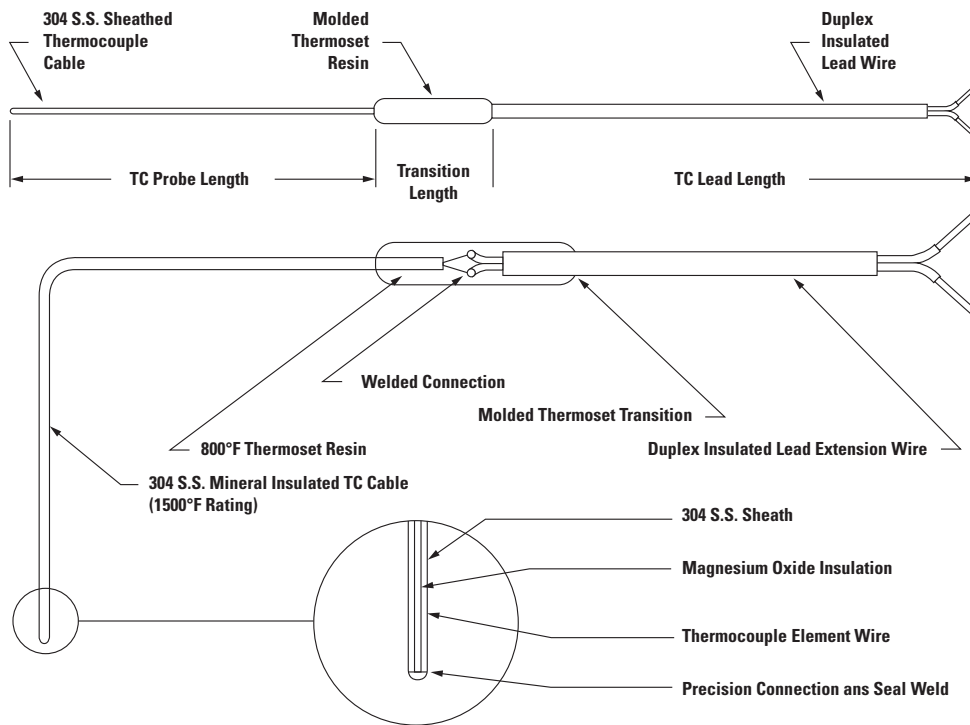

HIGH TEMP THERMOCOUPLES

Part Number	Type	Junction	Probe		Transition		Lead Length	Lead Type
			Dia.	Length	Dia.	Length		
MMT040JG06S48K	J	Grounded	.040"	6"	.188"	.750"	48"	Kapton
MMT040JG14S48K			.040"	14"	.188"	.750"		
MMT063JG06S48K			.063"	6"	.204"	.750"		
MMT063JG14S48K			.063"	14"	.204"	.750"		

Hi-Temp. Thermocouples



Miniature

For Hot Runner Molding Applications

- Type "J" calibration (others on request)
- Kapton leads
- Grounded junction
- OEM quality at substantial savings!
- Other probe & lead lengths on request

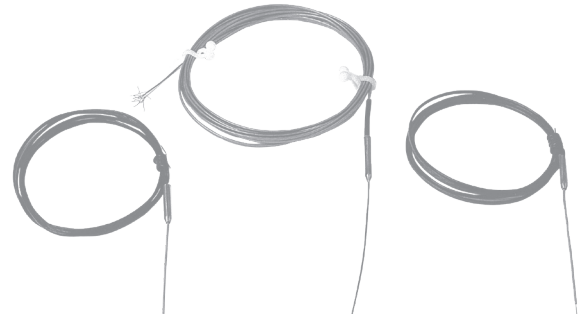

MINI HI-TEMP THERMOCOUPLES

Probe Dia.	Transition Dia.	Length	Lead Gauge	Probe Length	Lead Length	Part Number
.020"	.135"	.750"	#24	6"	48"	MHID020JG06S48T
.020"	.135"	.750"	#24	14"	48"	MHID020JG14S48T
.025"	.135"	.750"	#24	6"	48"	MHID025JG06S48T
.025"	.135"	.750"	#24	14"	48"	MHID025JG14S48T
.031"	.135"	.750"	#24	6"	48"	MHID031JG06S48T
.031"	.135"	.750"	#24	14"	48"	MHID031JG14S48T
.040"	.165"	.750"	#20	6"	48"	MHID040JG06S48T
.040"	.165"	.750"	#20	14"	48"	MHID040JG14S48T
.063"	.165"	.750"	#20	6"	48"	MHID062JG06S48T
.063"	.165"	.750"	#20	14"	48"	MHID062JG14S48T
.093"	.188"	.875"	#20	6"	48"	MHID093JG06S48T
.093"	.188"	.875"	#20	14"	48"	MHID093JG14S48T
.125"	.250"	.875"	#20	6"	48"	MHID125JG06S48T
.125"	.250"	.875"	#20	14"	48"	MHID125JG14S48T

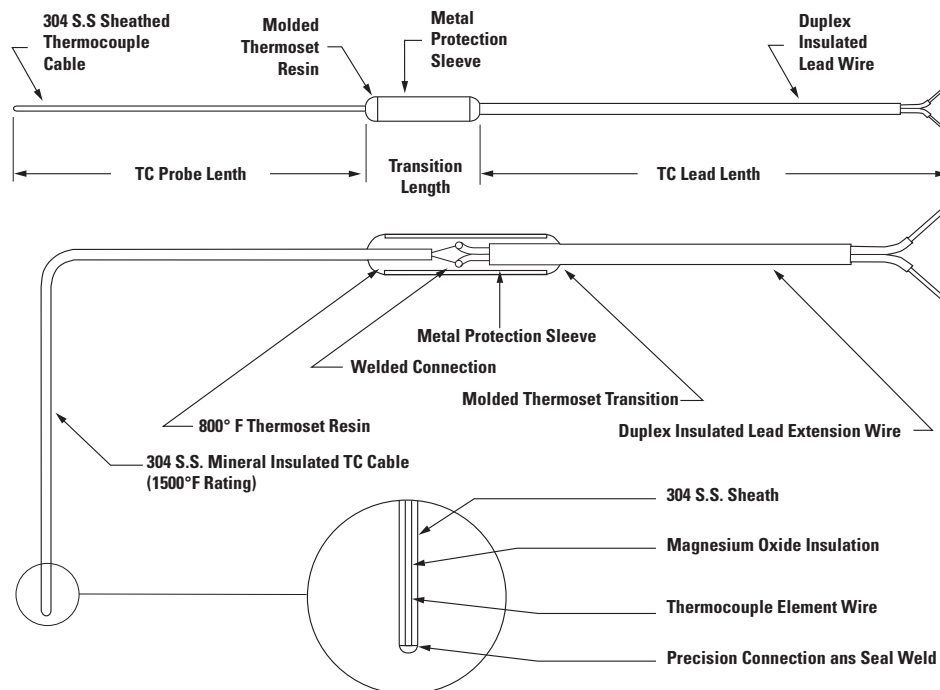



Hi-Temp. Thermocouples

Style "MSMT" Mini SLEEVE Molded Transition

Sensor accuracy and reliability are essential to the precise control of temperatures in multi-component industrial processing systems. Our mineral-insulated style "MSMT" thermocouples feature a metal-sleeved, high-temperature molded thermoset lead transition. The durable and cost-effective molded transition provides maximum strength, heat resistance and moisture resistance for demanding applications. These high-quality thermocouples are manufactured to stringent specifications and have gained a reputation for unsurpassed performance and reliability. All alloys used in the cable and leads meet or exceed the ANSI specifications for thermocouple grade wire. All lead types can be supplied with lead protection for additional abuse resistance. The precision-welded element and lead connections are totally encapsulated in a high-temperature thermoset material molded directly into a protective stainless steel cover.

The metal-sleeved, molded transition provides the highest level of moisture resistance and durability. The standard, metal-sleeved style molded thermoset transition is rated at 800°F. These thermocouples can be readily installed into small diameter thermowells, drilled holes or grooves. Tabs, rings and other fastening devices can be molded in to the transition or attached to the metal sleeve by brazed or welding.

Style "MSMT" Miniature Sleeve Molded Transition Thermocouples

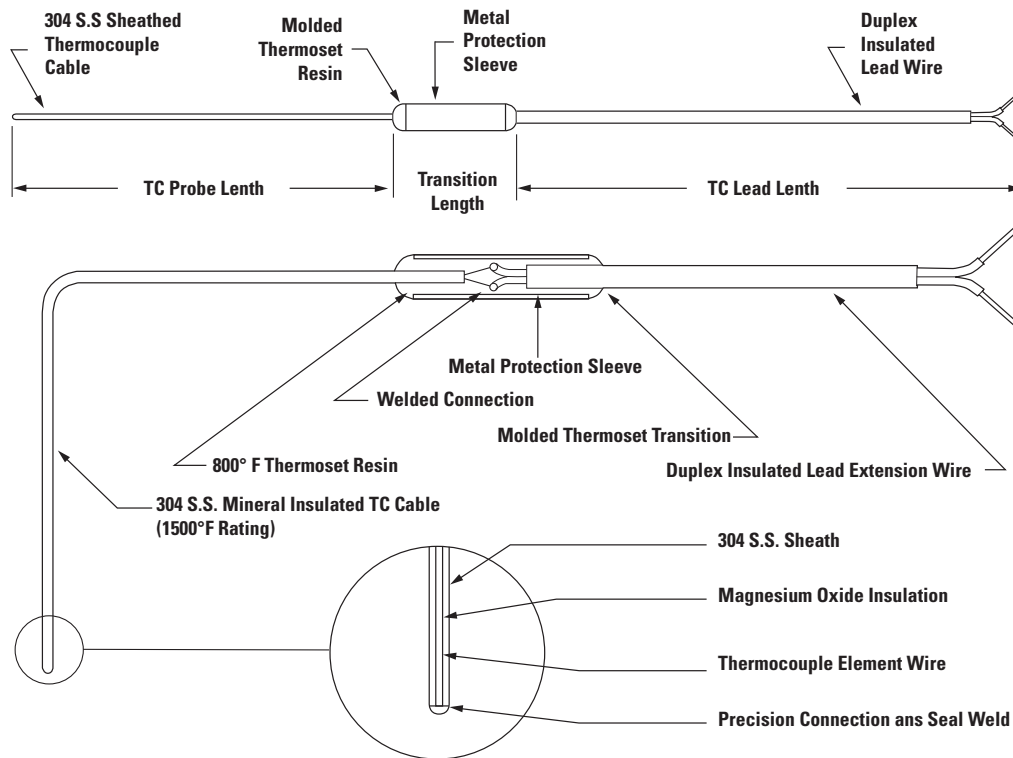

MINI SLEEVE

Part Number	Type	Junction	Probe		Transition		Lead Length	Lead Type
			Dia.	Length	Dia.	Length		
MSMT040JG06S48K	J	Grounded	.040"	6"	.165"	.750"	48"	Kapton
MSMT040JG14S48K			.040"	14"	.165"	.750"		
MSMT063JG06S48K			.063"	6"	.165"	.750"		
MSMT063JG14S48K			.063"	14"	.165"	.750"		

Thermocouples

Adjustable Depth

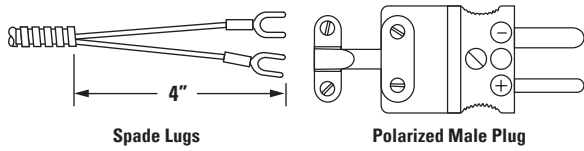

- Stainless steel leads
- Accurate to 1000°F
- Fits all standard adapters
- Fits hole depth from 1/2" to 10"
- Flexible probe bends to any angle
- Best selection, in-stock!

Type J–Stainless Overbraid - Adjustable Depth - Grounded

with Spade Lugs		with Polarized Male Plug	
Part Number	(A) Overall Length	Part Number	(A) Overall Length
ADT1024	24"	ADT1024P	24"
ADT1036	36"	ADT1036P	36"
ADT1048	48"	ADT1048P	48"
ADT1060	60"	ADT1060P	60"
ADT1072	72"	ADT1072P	72"
ADT1096	96"	ADT1096P	96"
ADT1120	120"	ADT1120P	120"
ADT1144	144"	ADT1144P	144"

Type J–Stainless Overbraid - Adjustable Depth - Ungrounded

with Spade Lugs	
Part Number	(A) Overall Length
ADT1030U	30"
ADT1036U	36"
ADT1048U	48"
ADT1072U	72"
ADT1096U	96"
ADT1120U	120"
ADT1144U	144"

ADJUSTABLE DEPTH-TYPE J

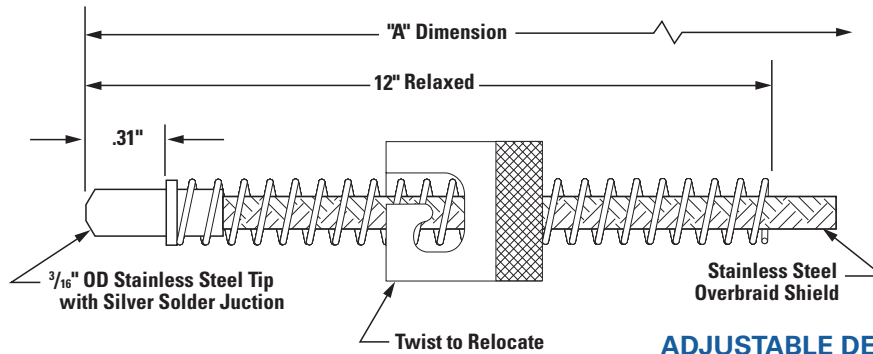

ADJUSTABLE DEPTH-TYPE K

Type K–Stainless Overbraid - Adjustable Depth - Grounded

with Spade Lugs		with Polarized Male Plug	
Part Number	(A) Overall Length	Part Number	(A) Overall Length
ADK1024	24"	ADK1024P	24"
ADK1036	36"	ADK1036P	36"
ADK1048	48"	ADK1048P	48"
ADK1072	72"	ADK1072P	72"
ADK1120	120"	ADK1120P	120"
ADK1144	144"	ADK1144P	144"



Thermocouples

Adjustable Depth - Armor Covered

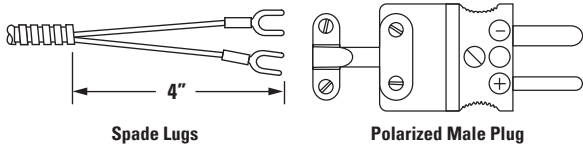

- Stainless steel armor leads
- Accurate to 1000°F
- Fits all standard adapters
- Fits hole depth from 1/2" to 10"
- Flexible probe bends to any angle
- Best selection, in-stock!

Type J—Armor Covered - Adjustable Depth - Grounded

ADJUSTABLE DEPTH-TYPE J

with Spade Lugs		with Polarized Male Plug	
Part Number	(A) Overall Length	Part Number	(A) Overall Length
AAT1024	24"	AAT1024P	24"
AAT1036	36"	AAT1036P	36"
AAT1048	48"	AAT1048P	48"
AAT1072	72"	AAT1072P	72"
AAT1096	96"	AAT1096P	96"
AAT1120	120"	AAT1120P	120"
AAT1144	144"	AAT1144P	144"

Type K—Armor Covered - Adjustable Depth - Grounded

AAK1024	24"	AAK1024P	24"
AAK1036	36"	AAK1036P	36"
AAK1048	48"	AAK1048P	48"
AAK1072	72"	AAK1072P	72"
AAK1120	120"	AAK1120P	120"
AAK1144	144"	AAK1144P	144"

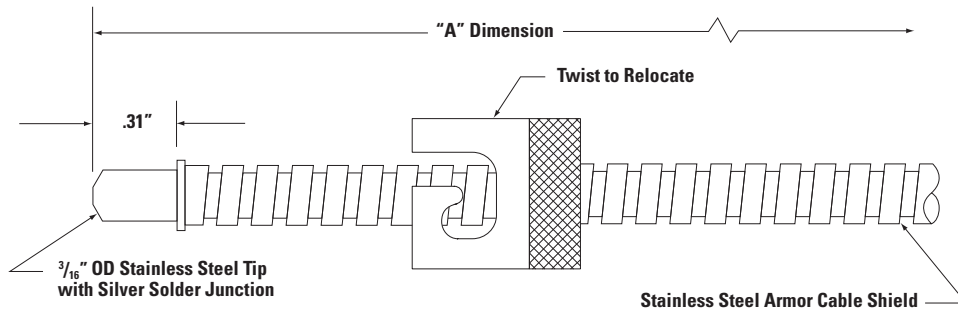

Adjustable Depth - Resistive Temp. Device (RTD)

DME adjustable depth RTDs can be used with thermocouple holes from 1/2" to 10" deep. Standardize on one model RTD for most requirements. Featuring threaded locking cap, which can be rotated or threaded up or down the spring to obtain the desired immersion length.

To install, place probe end in thermocouple hole allowing the tip to rest on the bottom of the hole. Screw bayonet cap down to bayonet adaptor, then back off 2 to 3 turns to provide tension. Push the cap down and twist-lock in place. The spring maintains positive pressure contact between probe tip and thermocouple hole bottom for accurate temperature readings.

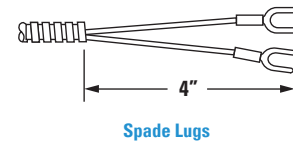
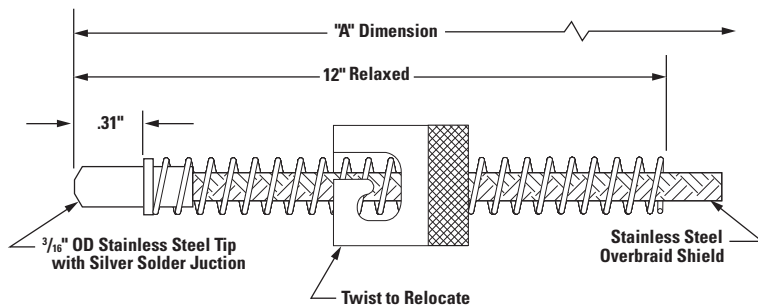

- 100 ohm platinum sensor
- 3/16" diameter probe
- 2-wire type
- Stainless overbraid
- In stock, low priced!

This is not a Thermocouple

Part Number	(A) Overall Length
RTD1024	24"
RTD1036	36"
RTD1048	48"
RTD1072	72"
RTD1120	120"

ADJUSTABLE DEPTH-RTD



F

Thermocouples

Spade Type

Spade thermocouples have the thermocouple sandwiched between two very thin stainless steel shims. They are usually installed between the heater band and the nozzle.

Type J		(A) Lead Length
Part Number		
STC48		48"
STC72		72"
Type K		(A) Lead Length
Part Number		
STK48		48"
STK72		72"

SPADE TYPE

More Sizes Available! Call for Pricing!





Thermocouples

Lug Mount



Our washer thermocouples are designed to be used for surface temperature readings of nozzles, barrels, molds, cylinders or die heads. These handy molding accessories can be mounted by a bolt, screw or threaded stud and nut.

Type J				
Part Number	(A) Lead Length	Washer I.D.	Screw or Bolt Size	Washer O.D.
WTC336	36"	3/16"	#6-8-10 Screw	3/8"
WTC348	48"	3/16"	#6-8-10 Screw	3/8"
WTC360	60"	3/16"	#6-8-10 Screw	3/8"
WTC372	72"	3/16"	#6-8-10 Screw	3/8"
WTC396	96"	3/16"	#6-8-10 Screw	3/8"
WTC3120	120"	3/16"	#6-8-10 Screw	3/8"
WTC536	36"	5/16"	1/4"-5/16" Bolt	21/32"
WTC548	48"	5/16"	1/4"-5/16" Bolt	21/32"
WTC560	60"	5/16"	1/4"-5/16" Bolt	21/32"
WTC572	72"	5/16"	1/4"-5/16" Bolt	21/32"
Type K				
Part Number	(A) Lead Length	Washer I.D.	Screw or Bolt Size	Washer O.D.
WTK536	36"	5/16"	1/4"-5/16" Bolt	21/32"
WTK548	48"	5/16"	1/4"-5/16" Bolt	21/32"
WTK560	60"	5/16"	1/4"-5/16" Bolt	21/32"
WTK572	72"	5/16"	1/4"-5/16" Bolt	21/32"

LUG MOUNT

Thermocouples

Pipe Clamp

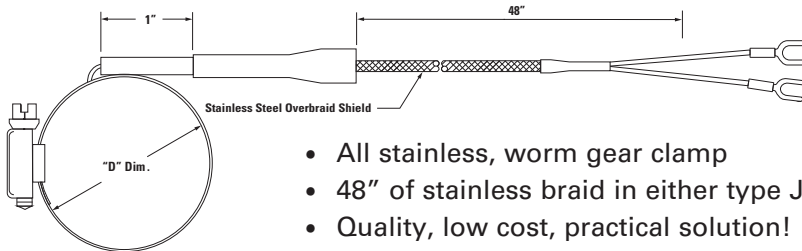

- All stainless, worm gear clamp
- 48" of stainless braid in either type J or K with spade lug terminations
- Quality, low cost, practical solution!

Pipe Clamp Thermocouple—Type J

Pipe Clamp Thermocouple—Type K

PIPE CLAMP

T/C Type	Clamping Range Inches	Part Number	TC Type	Clamping Range Inches	Part Number
			K	1/2 to 7/8	PCK006
J	7/8 to 1-1/2	PCJ016	K	7/8 to 1-1/2	PCK016
J	1-5/16 to 2-1/4	PCJ032	K	1-5/16 to 2-1/4	PCK032
J	2-1/4 to 3-5/16	PCJ048	K		
J	3-5/16 to 4-1/4	PCJ064	K		
J	4-1/4 to 5-1/4	PCJ096	K	4-1/4 to 5-1/4	PCK096

Pipe Clamp Adapters

Clamping Range Inches	Adapter O.A.L.	Part Number
1/2 to 7/8	1 3/4"	PCA100



Thermocouples



Bendable Probe

The Bendable Probe Thermocouple is designed for hard-to-reach places. The probe tube can be bent to any angle. This thermocouple can also be used in a variety of hole depths.

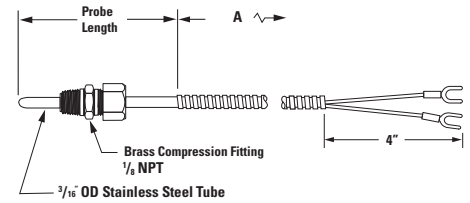

BENDABLE PROBE

Bendable Probe Thermocouples – Includes Compression Fitting

Part Number	(A) Overall Length	Probe Length	Diameter	TC Type
BPJ6048	48"	6"	3/16"	J
BPJ6072	72"	6"	3/16"	J
BPJ60120	120"	6"	3/16"	J
BPJ1248	48"	12"	3/16"	J
BPJ1272	72"	12"	3/16"	J
BPJ12120	120"	12"	3/16"	J
BPK6048	48"	6"	3/16"	K
BPK6072	72"	6"	3/16"	K
BPK60120	120"	6"	3/16"	K
BPK1248	48"	12"	3/16"	K
BPK1272	72"	12"	3/16"	K
BPK12120	120"	12"	3/16"	K

Extra Compression Fittings

Part Number
CF68-3-2

Thermocouples

Melt Bolt

Melt Bolt Thermocouples are used to measure the melt temperature as it moves down the extruder barrel, and is in direct contact with the melting plastic for the most accurate readings.

- 1/8" tip diameter
- 1/2 - 20 UNF thread
- 20,000 P.S.I. pressure rating
- 1000°F maximum temperature
- Grounded for faster response
- 304 stainless bolt & extensions

More Sizes Available!
Call for Pricing!

MELT BOLT

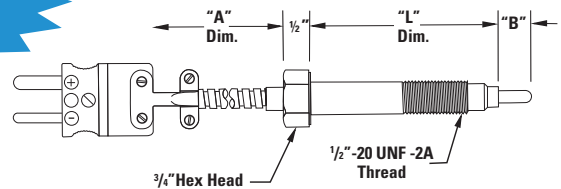

Flexible Extension - Type J

Flexible Extension - Type K

TC Type	(L) Bolt Length	Part Number	(B) Tip Length	"A" Length	TC Type	(L) Bolt Length	Part Number	(B) Tip Length	"A" Length
J	3"	MBJ0-3F	Flush	4"	K	3"	MBK0-3F	Flush	4"
J	3"	MBJ2-3F	1/8"	4"	K	3"	MBK2-3F	1/8"	4"
J	3"	MBJ4-3F	1/4"	4"	K	3"	MBK4-3F	1/4"	4"
J	6"	MBJ0-6F	Flush	4"	K	6"	MBK0-6F	1/8"	4"
J	6"	MBJ2-6F	1/8"	4"	K	6"	MBK2-6F	1/4"	4"
J	6"	MBJ4-6F	1/4"	4"	K	6"	MBK4-6F	Flush	4"



Thermocouples

Newbury (Type J)

Newbury OEM-type thermocouples are held in place by means of a set screw which is tapped into the nozzle hex. The thermocouple junction is side sensing and can be inserted from either side of the nozzle. The probe is 1/8" diameter by 1" long with a 90° bend, strain reliever and stainless braid leads.

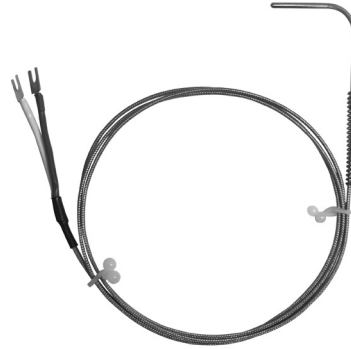

Part Number	Overall Length
NNT48	48"
NNT72	72"





NEWBURY

Thermocouples

Extensions

Part Number	Lead Length
-------------	-------------

EXTENSIONS

SEM48	48"	Male plug braid SEM part numbers 
SEM72	72"	
SEM120	120"	
SEF48	48"	Female plug braid SEF part numbers 
SEF72	72"	
SEF120	120"	
AEM48	48"	Male plug armor AEM part numbers 
AEM72	72"	
AEM120	120"	
AEF48	48"	Female plug armor AEF part numbers 
AEF72	72"	
AEF120	120"	

Thermocouple extensions stock - Type J; all other types on request.

Thermocouples



Ring Mount

Gasket thermocouples can be quickly and firmly secured to any flat surface with an appropriate sized bolt. Gasket thermocouples are often used in parallel with other types of sensors to create an average temperature measurement between surface and internal temperatures.

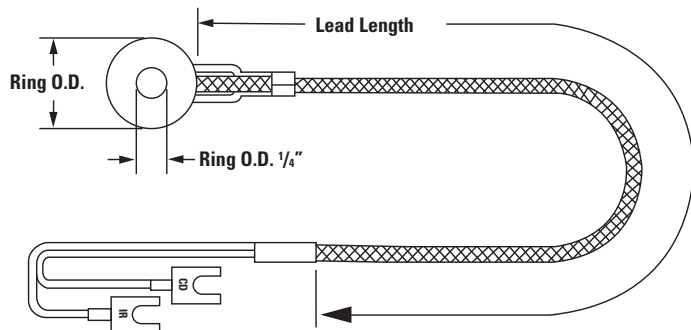

Part Number	Desc.
60J723	SS br. 72" str.
60J91201	SS br. 120" 90 deg. plug
60J9723	Kapton 72" 90 deg.
60J91443	Kapton 144" 90 deg.

RING MOUNT

Thermocouples

Rigid Probe Thermocouples

Rigid probe thermocouples are useful in a wide variety of solid, gas and liquid temperature applications.

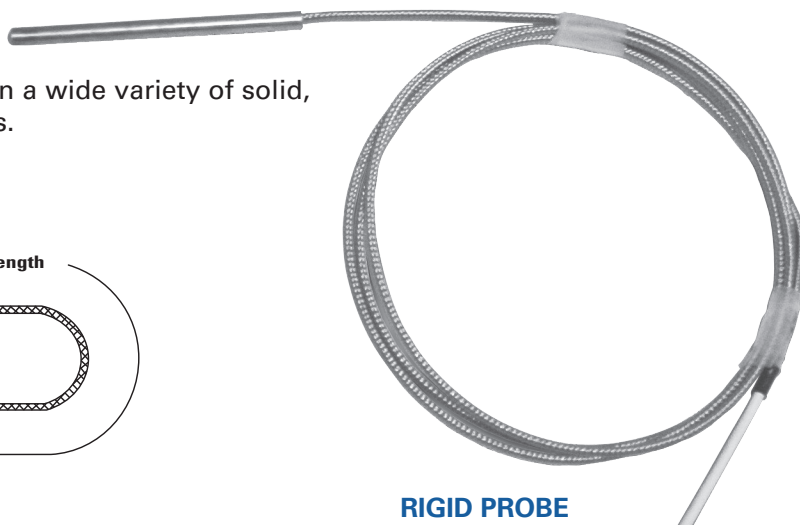
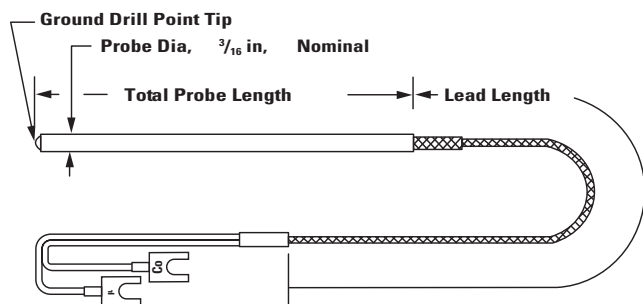

RIGID PROBE

All Thermocouples Listed Below are Type J

Part Number	Probe	Lead Description
RPTC11	1/8" dia. x 1" long	36" stainless steel braid
RPTC14	1/8" dia. x 2" long	72" stainless steel braid
RPTC01	3/16" dia. x 1/2" long	48" stainless steel braid
RPTC02	3/16" dia. x 3" long	48" stainless steel braid
RPTC03	3/16" dia x 3" long	72" stainless steel braid





Insulated Quick Disconnects

“Quick-Slide” male and female fully Insulated Quick Disconnects give reliable connection, and resist corrosion and arcing while improving conductivity. Funnel barrel for easy insertion of wire. Centered male blade allows reversible entry; female connector has corrugated barrel.

- Rated for 300VAC
- 221°F/105°C
- Tab size - .250" x .032"

50 Pieces Per Bag	Male/Female Wire Range	Male 22-18	Female 22-18	Male 16-14	Female 16-14
	Part Number	NQM-2216	NQF-2216	NQM-1614	NQF-1614



Non-Insulated Quick Disconnects

50 Pieces Per Bag	Male/Female Wire Range	Male 22-18	Female 22-18	Male 16-14	Female 16-14
	Part Number	QM-2216	QF-2216	QM-1614	QF-1614

Bayonet Adapters

1/8-27 N.P.T.		3/8-24 N.F.		BAYONET ADAPTERS
Part Number	Length	Part Number	Part Number	
BA-72	7/8"	BA-76		
BA-202	1 1/4"	BA-206		
BA-362	2 1/4"	BA-366		
BA-562	3"			



Metric-to-English Adapters

Metric Thread	English Thread	Length	Part Number
10 x 1.5	1/8-27	1"	MBA-10
12 x 1	1/8-27	1"	MBA-12
14 x 1.5	1/8-27	1"	MBA-14

Screw into metric threaded hole and then use standard 1/8-27 NPT Bayonet Adapter



METRIC TO ENGLISH ADAPTERS

Panel Jacks

Part Number	Size	Descpt.	PANEL JACKS
630RJ	1-1/8" dia.	Round - J	
630RK	1-1/8" dia.	Round - K	
630RJM	1-1/8" dia.	Mini - J	
631J1	2" square	1 Jack	
631J5	3-1/4" x 5"	5 Jack	
631J5M	2" x 4"	5 - Mini J	

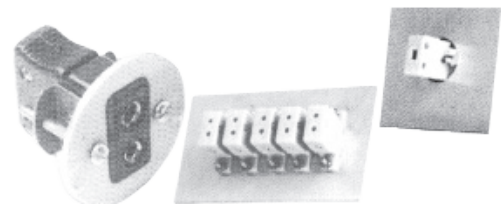

Standard Male Plugs



STANDARD MALE PLUGS

Part Number
MPJ
MPK

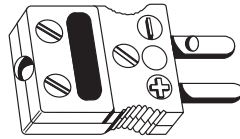

Glass-filled nylon -
rated to 400°;
type J is black,
type K yellow

Standard Female Jacks

Part Number
FJJ
FJK

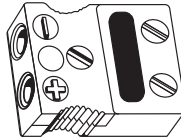

Glass-filled nylon -
rated to 400°;
type J is black,
type K yellow

STANDARD FEMALE JACKS

Miniature Male Plugs

Part Number
MMPJ
MMPK

MINI MALE PLUGS

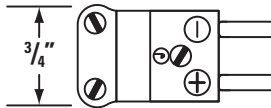

Glass-filled nylon -
rated to 400°;
type J is black,
type K yellow

Miniature Female Jacks

Part Number
MFJJ
MFJK

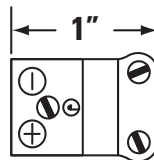

Glass-filled nylon -
rated to 400°;
type J is black,
type K yellow

MINI FEMALE JACKS

Cable Clamp

Part Number	Size
CC610	Std
CCM610	Mini

CABLE CLAMP





Thermocouple Wire

High Temperature

- High quality
- In stock for immediate shipment

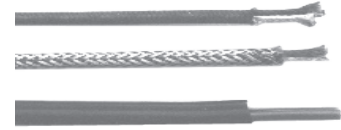

THERMOCOUPLE WIRE

Thermocouple Extension Wire

Part Number	Wire Size	Wire Type	Rated Description	°F	Wire	Overall
Type J						
TCEW1	20 Ga	Stranded	Fiberglass Jacket Over Insulated Duplex Parallel Conductors	900°	Glass	Glass
TCEW1S	20 Ga	Solid	Fiberglass Jacket Over Insulated Duplex Parallel Conductors	900°	Glass	Glass
TCEW2	20 Ga	Stranded	Stainless Braid Jacket Over Fiberglass Insulated Duplex Parallel Conductors	900°	Glass	Stainless
TCEW2S	20 Ga	Solid	Stainless Braid Jacket Over Fiberglass Insulated Duplex Parallel Conductors	900°	Glass	Stainless
TCEW3	20 Ga	Stranded	PVC Jacket Over Insulated Duplex Parallel Conductors	220°	PVC	PVC
TCEW3S	20 Ga	Solid	PVC Jacket Over Insulated Duplex Parallel Conductors	220°	PVC	PVC
TCEW6	20 Ga	Stranded	PTFE Jacket Over Insulated Duplex Parallel Conductors	500°	PTFE	PTFE
TCEW6S	20 Ga	Solid	PTFE Jacket Over Insulated Duplex Parallel Conductors	500°	PTFE	PTFE
Type K						
TCEW8	20 Ga	Stranded	Fiberglass Jacket Over Insulated Duplex Parallel Conductors	900°	Glass	Glass
TCEW9	20 Ga	Stranded	Stainless Braid Jacket Over Fiberglass Insulated Duplex Parallel Conductors	900°	Glass	Stainless
TCEW12S	20 Ga	Solid	Parallel Conductors	Red 220°	PVC	PVC

Stainless Steel Armor

STAINLESS STEEL ARMOR

Use for molding machines, granulators, chillers, general wiring, heater extensions, controller wiring and all types of plant applications. Stainless armor will withstand extremes in heat (1700°F) and abrasion without rusting or crushing.



- Use on heater bands, cartridge heaters, thermocouples, etc.
- Solid stainless steel construction
- Crush-resistant shielding, easy to install
- Rust, corrosion, and vibration resistant

Part Number	I.D. Inches	O.D. Inches	Bend Radius
SSA316	3/16 (.187)	9/32	1-7/8"
SSA140	1/4 (.250)	11/32	2"
SSA380	3/8 (.375)	1/2	2-1/4"
SSA120	1/2 (.500)	5/8	2-1/2"

Heater Wire



High Temperature - Type TGGT

HEATER WIRE

600 volt/250°C
 Conductor: flexible stranded, 10% nickel-plated copper
 Tape Wrap: PTFE tape
 Insulation: ceramic tape
 Jacket: PTFE-impregnated glass braid
 Physical Properties: The ceramic tape insulation combines high dielectric strength with excellent flexibility and ease of stripping to achieve a lead wire of superior resistance to high temperature, abrasion, chemicals and moisture.

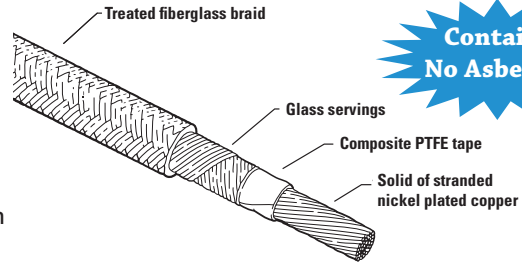

Contains No Asbestos

Listing: listed by UL (style 5251) and CSA (type C3)
 Nominal Thickness: TFE tape - all sizes .015" (.38mm); ceramic tape -24-8 AWG .010" (.25mm) 6-4/0 AWG .015" (.38mm); glass braid - 2408 AWG .005" (.13mm) 6-2 AWG .0075" (.19mm) 1-4/0 AWG .010" (.25mm)

Best utilized: for internal wiring of heating equipment, wiring and extensions for heating equipment used in plastics processing, heating equipment and industrial cooking equipment.

Hi-Temp Heater Extension Wire 482° Rated (750°F. Intermittent)

Part Number	Size AWG	Strand	Nom. O.D. (In./mm)	Bend Rad. (In./cm)	Ampacity*
TGGT18	18	19 x .010	.114/2.90	.66/1.68	23
TGGT16	16	26 x .010	.124/3.15	.72/1.83	40
TGGT14	14	41 x .010	.140/3.56	1.12/2.84	53
TGGT12	12	65 x .010	.162/4.11	1.28/3.25	70
TGGT10	10	105 x .010	.204/5.18	1.48/3.76	93
TGGT8	8	168 x .010	.248/6.30	2.30/5.87	115

*Ampacity is based on maximum conductor temperature of 250°C in free air at ambient temperature of 30°C

Heater Wire

HEATER WIRE

600 volt/450°C
 Conductor: flexible, stranded, 27% nickel-clad copper
 Insulation: glass reinforced mica tapes
 Jacket: glass braid impregnated with high-temperature finisher
 Physical Properties: superior resistance to high temperature and the effects of radiation; insulating materials retain their integrity after exposure to 1012

High Temperature - Type MG

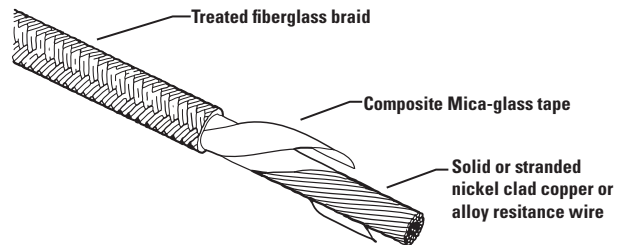

Listing: listed by UL (style 5107) CSA - applied for
 Nominal Thickness:
 Insulation Jacket
 22-12 AWG .025" (.64mm); 22-12 AWG .007" (.18mm)
 10-4 AWG .030" (.76mm); 10-4 AWG .015" (.38mm)
 2-4/0 AWG .035" (.89mm) 2-4/0 AWG .020" (.51mm)

Best utilized: for wiring high temperature heating equipment, wiring and extensions for heating equipment used in plastic processing machinery. Well suited for presses and extruders, hot gates etc.

Extreme Temp Heater Extension Wire 868° Rated (1350°F. Intermittent)

Part Number	Size AWG	Strand	Nom. O.D. (In./mm)	Bend Rad. (In./cm)	Ampacity*
MG20	20	7 x .0126	.110/2.79	.66/1.68	27
MG18	18	19 x .010	.120/3.05	.72/1.83	39
MG16	16	26 x .010	.131/3.33	.78/1.97	51
MG14	14	41 x .010	.142/3.61	1.12/2.84	64
MG12	12	65 x .010	.163/4.14	1.20/3.04	86
MG10	10	105 x .010	.226/5.74	1.76/4.49	115
MG8	8	168 x .010	.266/6.76	2.60/6.63	120

*Ampacity is based on maximum conductor temperature of 250°C in free air at ambient temperature of 30°C



Sheathed Cables

Multiconductor Silicone-Insulated & Sheathed Cables

- Cables are UL and CSA approved
- -60°C to +200°C continuous working temperatures
- Good resistance to thermal shock
- Excellent aging resistance
- 600V working voltage
- Outer sheath is brick red in color

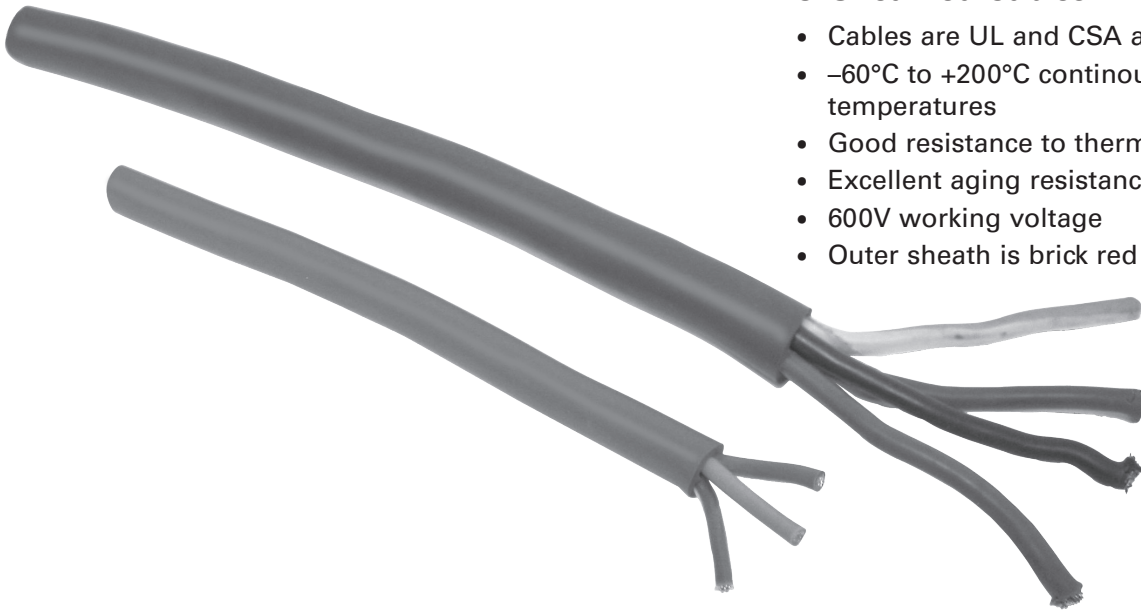

SHEATHED CABLES

Number of Conductors	AWG	Part Number
3 core	16 gauge	CORE3
4 core		CORE4

Silicone Sleeving

Custom-formulated silicone rubber extruded over electrical grade braided fiberglass

- Flexible
- Grade C
- -70°C to +200°C temperature range



SILICONE SLEEVING

Part Number	I.D.
SS12M	0.133
SS25M	0.263
SS31M	0.313
SS37M	0.375
SS50M	0.5

Spring Return Wire Strippers-KCT600

- Cuts and strips copper or aluminum 10–18 AWG solid and stranded wire
- Holes on the side of the jaws are intended for looping solid wire
- Use pliers to tighten or loosen small nuts
- Precision ground cutting and stripping jaws
- Spring return

•

KCT600





Fiberglass Sleeving

Special high-temperature "E" Type Fiberglass® developed to provide protection in elevated temperatures that are encountered with molding and extruding applications. E-Glass is non-fray sleeving which is heat treated to remove impurities in the yarn and to retard fraying and splaying. Passes VW-1 flammability requirements. Sleeving may be easily distended to cover terminals and solder connections.

Temperature Ranges:

Continuous service: 500°F (260°C)
Sustained service: 800°F (430°C)
Intermittent use: 1400°F (760°C)



FIBERGLASS SLEEVING

Part Number	Nominal Size	Sleeve I.D.	Fits Wire Sizes
FGS12	12	.091	1 - #12 Wire or Smaller 2 - #18 Wire
FGS7	7	.158	1 - #7 Wire or Smaller 2 - #14 Wires 3 - #16 Wires
FGS2	2	.278	2 - #8 Wires 3 - #12 Wires 6 - #18 Wires 10 - #22 Wires
FGS50	1/2"	.524	4 - #8 Wires 6 - #12 Wires 8 - #14 Wires 12 - #18 Wires 18 - #22 Wires

- Made in USA
- High quality, low price!
- Use for: wire, cable, hose, ducting, retaining and repair

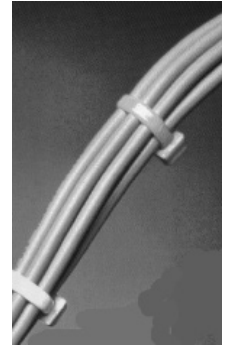
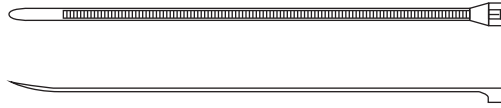

Ties feature a patented locking system that assures a firm grip. These natural-color cable ties have smooth edges and a taper tip for easy installation. UL approved.

Natural Color (off white) Ties

Part Number	Length O.A.	Max. Dia.	Tensile Looped	Pieces Per Bag
NCT4	4"	$1\frac{3}{16}$ "	18	100
NCT7	7"	$1\frac{3}{4}$ "	50	100
NCT11	11"	3"	50	100
NCT14	14"	4"	50	100
NCT14HD	$14\frac{1}{2}$ "	4"	175	100
NCT18HD	$18\frac{1}{2}$ "	$5\frac{1}{4}$ "	175	50
NCT24HD	$24\frac{1}{2}$ "	7"	175	50

NYLON CABLETIES

Black Color Ties

Part Number	Length O.A.	Max. Dia.	Tensile Looped	Pieces Per Bag
NCT4BLK	4"	$1\frac{3}{16}$ "	18	100
NCT7BLK	7"	$1\frac{3}{4}$ "	50	100
NCT11BLK	11"	3"	50	100
NCT14BLK	14"	4"	50	100
NCT14HDBLK	$14\frac{1}{2}$ "	4"	175	100
NCT18HDBLK	$18\frac{1}{2}$ "	$5\frac{1}{4}$ "	175	50
NCT24HDBLK	$24\frac{1}{2}$ "	7"	175	50



Cable Tie Bases

These Cable Tie Bases make mounting wire and cable a quick, easy and secure process. They are designed so they can be screw-mounted, and they also have an adhesive backing for extra easy application.

Black Nylon Cable Tie Base

CABLE TIE BASES

Part Number	Description
6295	0.75" x 0.75" Base
6297	1" x 1" Base

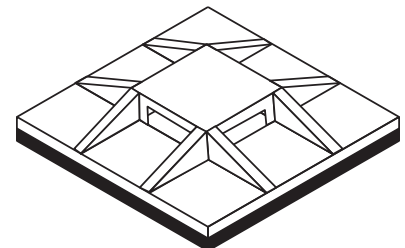



Butt Connectors

	Part Number	Max. Temp.	Wire Size
Non-Insulated	BCC18	600°F	22-18
	BCC14	600°F	16-14
	BCC10	600°F	12-10
	BCS18	900°F	22-18
	BCS14	900°F	16-14
	BCS10	900°F	12-10
Nylon Insulated	BCC18N	300°F	22-18
	BCC14N	300°F	16-14
	BCC10N	300°F	12-10



BUTT CONNECTORS

High Temperature Terminal Lugs

Features & Construction

- Wire ranges clearly marked on all terminals
- Load capacity greater than wire itself
- One-piece construction for greater strength & economy
- Full ¼" long shank provides extra length for fast, easy location when crimping, and wide crimping area for permanent vibration-free and moisture-proof connections
- Extra added feature - beveled O.D.

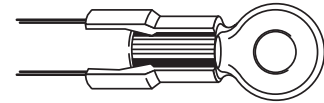

Extreme Temp. Terminal Lugs - 900°F

Part Number	Wire Size	Stud Size
HTTL18	22-18	1/8
HTTL14	16-14	3/16
HTTL10	12-10	3/16

TERMINAL LUGS

Tan/Red Super Wire Connectors



3M®

Features

- One connector replaces three
- Compact size and red miniskirt
- Quick bite spring design
- Comfortable wing design for a better grip
- UL listed, CSA certified & CE
- Temp rating 221°F/105°C
- 600 volts maximum

TRBOX

100 pieces per box

Tan/Red Super Wire Connectors



Ceramic Wire Connectors

- For very high temperature applications
- Usable up to 1740°F/950°C
- Ribbed design for easy use
- 600 volt max.

CERAMIC WIRE CONNECTORS

F

Part Number	Wire Sizes	
	Min.	Max
CWN20	2-#16	2-#16 & 1-#18
CWN16	3-#16	2-#16 & 2-#18
CWN10	2-#14	3-#16 & 1-#18





Ceramic Terminal Covers

Part Number	Thd Size
CTC1024	10-24
CTC1032	10-32

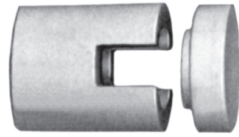

CERAMIC TERMINAL COVER

Economy Glass Tape

Economy Glass Cloth Therm-X Electrical Tapes are designed to offer efficiencies in application and versatility in selection.

730 Glass Cloth Electrical Tape

- Operates at 130° (266°F)
- 7 mil. thickness
- Roll length 180'

7300 Glass Cloth Electrical Tape

- Operates at 180° (356°F)
- 7.5 mil. thickness
- Roll length 108'



Part Number	Width	Rated Temp Range	Thickness	Length
730-500	1/2"	266°F/130°C	7 Mil	180'
730-750	3/4"	266°F/130°C	7 Mil	180'
730-1000	1"	266°F/130°C	7 Mil	180'
7300-500	1/2"	356°F/180°C	7.5 Mil	108'
7300-750	3/4"	356°F/180°C	7.5 Mil	108'
7300-1000	1"	356°F/180°C	7.5 Mil	108'

ECONOMY GLASS TAPE

PVC Electrical Tape

PVC Electrical Tape

Part Number ET750

- 7 mil., 3/4" wide, 60' long
- UL listed
- Individually cello wrapped
- All purpose – all weather
- Service temperature: 176°F/80°C



3M Vinyl Electrical Tape

- 7 mil., 3/4" wide, 66' long
- UL & SA listed
- Stickier, stretchier and highly conformable
- All purpose – all weather
- Operating range up to 20°F/105°C
- Flame-retardant
- Hot and cold weather-resistant
- Use Super 33 + as a primary insulation for wire cable splices up to 600V and for fixture and wire splices up to 1 kV

Meets requirements of ASTM d-3005 Type 1, UL 510, HHI-595C and CSA C22.2

PN # SUPER 33



Features

- 7 mil, 3/4" wide, 66' long
- 9 colors
- UL listed & CSA certified
- All purpose - all weather

35**
1 roll (3/4" x 66')

** To complete part number, add the color of the tape desired from the list to the right (e.g. Red tape would make the part number 35RED)

**Product on
this page is
no longer**

- Color coding, phase identification, marking, wire harnessing
- Temp rating 220°F/105°C



Colors Available

- RED
- GREEN
- BROWN
- WHITE
- YELLOW
- GRAY
- ORANGE
- VIOLET

3M Electrical Tape Multi-Pack

Features

- 5 colors in one pack: blue, green, red, white & yellow
- Color coding, phase identification, marking, wire harnessing

PN: 35 Multipack
5 rolls (1/2" x 20')

available

- 7 mil - 1/2" wide x 20' long
- UL listed & CSA certified
- All purpose - all weather
- Temp rating 220°F/105°C



3M Hi-Heat Electrical Tapes

3M Hi-Heat Electrical Tapes are ideal for use on heater bands and thermocouple lead extensions as well as all high-heat applications. We offer two temperature ratings and mill thicknesses. Both are thermosetting and pressure sensitive for a long service life.

27 Glass Cloth Electrical Tape

- Operates at 130°C (266°F)
- 7 mil thickness
- UL recognized component listing for 150°C (guide OANZ2, file E17385). CSA accepted component 130°C file LR93411. Meets MIL-I-15126F type GFT

Part Number	Width	Rated Temp Range	Thickness
27-500	1/2"	266°F/130°C	7 Mil
27-750	3/4"	266°F/130°C	7 Mil
69-500	1/2"	356°F/180°C	7.5 Mil
69-750	3/4"	356°F/180°C	7.5 Mil

69 Glass Cloth Electrical Tape

- Operates at 180°C (356°F)
- 7.5 mil thickness
- Meets requirements of MIL-I-19166C and has UL recognized component listing for 200°C (guide OANZ2, file E17385). CSA accepted component 180°C file LR93411





GPMS Solid State Relays

Applications for Solid State Relays are typically used to operate devices such as motors, heaters and lights from low-power signals such as those generated by computers, microprocessors and other logic systems. Here are some examples: heating controls, P.C. drilling machines, industrial process controls, electrostatic precipitators, electromagnets, assembly equipment, plastics thermoforming, welding controls, artificial vision systems, fire and alarm systems, production equipment, lubrication systems, industrial fans and blowers, utility control systems.



Long life reliability when properly used, the Solid State Relay (SSR) provides a high degree of reliability, long life and reduced Electro-Magnetic Interference(EMI), together with fast response and high vibration resistance. No moving parts; the absence of moving parts means that there is nothing to "wear out." Fast switching Solid State Relays can switch up to 80 times per second, much faster than any electro-mechanical relays low input power required SSR's allows the switching of high loads via ultra-sensitive input power. A low level logic signal (TTL) can activate a switch for as much as 100 AMPS. Resistant to shock and vibration, our solid state relays are filled with an epoxy compound. When cured, the epoxy hardens so that the finished relay is a solid block. This prevents damage to the unit by the shock or vibration present in many industrial usages. Quiet operation, completely quiet switching. Beneficial in many areas where quiet operations are desirable.

- Optically isolated
- Built-in snubber
- 4000 volt isolation
- Zero voltage turn-on
- Direct copper bonded SCR's
- High surge capability
- 100% tested at rated current
- UL recognized
- CSA certified
- CE compliance
- 600 volt peak blocking voltage (1200 volt peak blocking voltage)*
- LED status indicator*
- Clear safety cover included*

* Features available on the 660 volt AC output models only

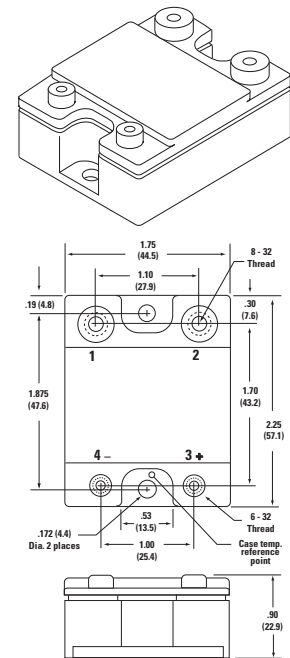
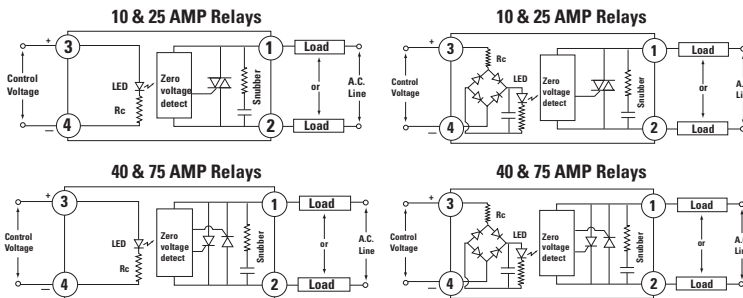

DC Control Models

Part Number	Maximum Current	Line Voltage	Min. Control Voltage	Max. Control Voltage
610DC	10A	24-330 VAC	3 VDC	32 VDC
625DC	25A	24-330 VAC	3 VDC	32 VDC
640DC	40A	24-330 VAC	4 VDC	28 VDC
675DC	75A	24-330 VAC	4 VDC	28 VDC
500DC	50A	48-660 VAC	4 VDC	28 VDC
750DC	75A	48-660 VAC	4 VDC	28 VDC
AC Control Models				
610AC	10A	24-330 VAC	100 VAC	280 VAC
625AC	25A	24-330 VAC	100 VAC	280 VAC
640AC	40A	24-330 VAC	100 VAC	280 VAC
675AC	75A	24-330 VAC	100 VAC	280 VAC
500AC	50A	48-660 VAC	100 VAC	280 VDC
750AC	75A	48-660 VAC	100 VAC	280 VDC

- Totally encapsulated
- Moisture resistant
- Stainless steel tube
- High speed
- Hermetically sealed
- Long lasting
- Cool and quiet
- High reliability
- 3 styles available:
 - Single pole
 - Double pole
 - Triple pole

• , & Listed

Specifications

Life: Five million operations minimum for resistive loads
 Dielectric withstand: min. 2500VRMS
 Temperature range: -35°C to 85°C
 Coil terminals:
 #6 binding head screws
 Load terminals:
 Pressure connectors,
 AWG #6-14 for 35A
 AWG #2-12 for 60A
 Operate time: .05 second
 Release time: .08 second
 Contact resistance:
 35 AMP: .003 Ohms
 60 AMP: .002 Ohms
 Pull-In Voltage: 65% of normal

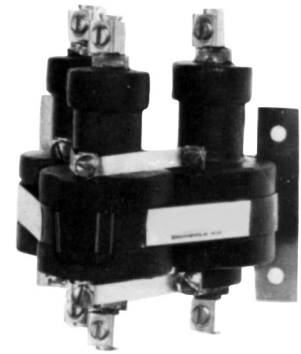

MERCURY CONTACTORS

1 Pole-Normally Open

Part Number	Contact Rating at 480VAC	Coil Information		
		Voltage	Watts	Volt AMP
MC35-1201	35 A.	120	3.5	6.4
MC35-2401	35 A.	208/240	3.2/4.0	5.4/7.0
MC60-1201	60 A.	120	2.9	5.8
MC60-2401	60 A.	208/240	3.0/4.0	5.2/7.0
MC100-1201	100 A.	120	7.1	16.4
MC100-2401	100 A.	208/240	7.5	16.1

2 Pole-Normally Open

Part Number	Contact Rating at 480VAC	Coil Information		
		Voltage	Watts	Volt AMP
MC35-1202	35 A.	120	7	12.8
MC35-2402	35 A.	208/240	6.4/8.0	10.8/14.0
MC60-1202	60 A.	120	5.8	11.6
MC60-2402	60 A.	208/240	6.0/8.0	10.4/14.0
MC100-1202	100 A.	120	14.2	32.8
MC100-2402	100 A.	208/240	15	32.2

3 Pole-Normally Open

Part Number	Contact Rating at 480VAC	Coil Information		
		Voltage	Watts	Volt AMP
MC35-1203	35 A.	120	10.5	19.2
MC35-2403	35 A.	208/240	9.6/8.0	16.2/21.0
MC60-1203	60 A.	120	8.7	17.4
MC60-2403	60 A.	208/240	9.0/12.0	15.6/21.0
MC100-1203	100 A.	120	21.3	49.2
MC100-2403	100 A.	208/240	22.5	48.3

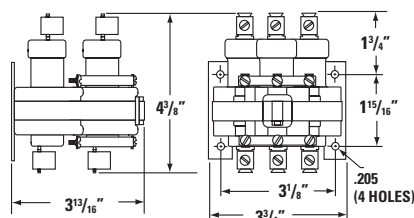
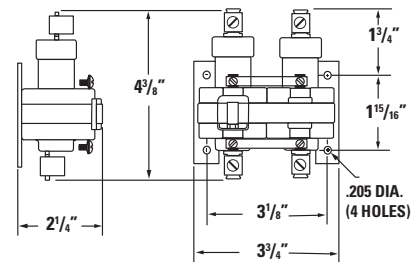
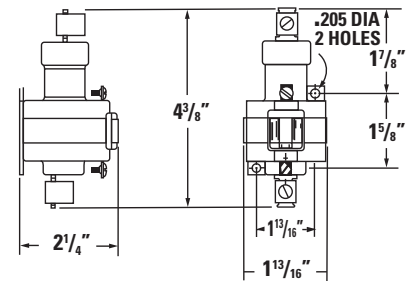



30 AMP Contactors

Quantum IM Mounts

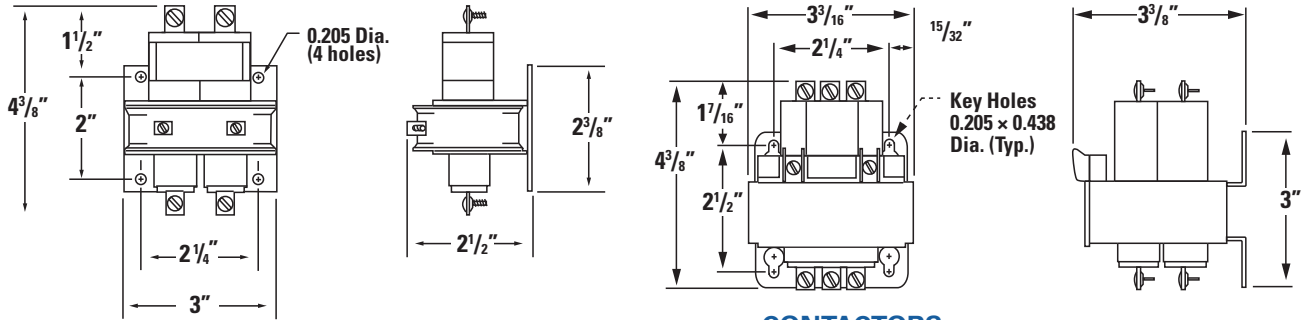

CONTACTORS

Double Pole

Part Number	Voltage	Wattage	Volt AMPS
CMC30-24DC2	24 VDC	6.3	6.3
CMC30-24AC2	24V-50/60Hz	4.9	13.9
CMC30-1202	120V-50/60Hz	4.9	13.8
CMC30-2402	220V-50/60Hz	4.4	11.7

Triple Pole

Part Number	Voltage	Wattage	Volt AMPS
CMC30-24DC3	24 VDC	5.2	5.2
CMC30-24AC3	24V-50/60Hz	5.0	19.6
CMC30-1203	120V-50/60Hz	4.2	16.8
CMC30-2403	220V-50/60Hz	3.9	14.5

- Contact resistance
- Dielectric withstand 2,500 VAC RMS min
- Operation time: 50 mille second
- Release time: 70 mille second
- 30 AMP @ 600 RES rating per pole
- PTFE plunger guides
- UL listing CSA certified
- Coil terminals - #6 screw
- Load terminals - #8 screw

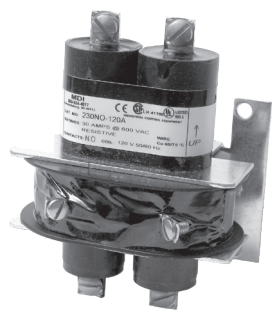

Voltage Sensor

With Both Visual and Audible Alarm!



- Detects 50–1000 volts AC
- CAT3 & CAT4 rated
- Detects defective grounds
- No switch required - always ready to go!
- Buzzer will only react to an AC field - NOT static electricity
- Safety instrument - locates defective grounds, breaks in wires, energized circuits, blown fuses, etc.
- Non-conductive surfaces
- Personal verification - lockout/tagout procedures

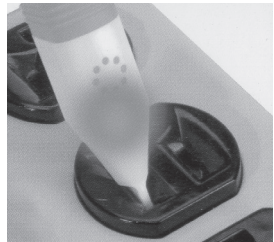

Part Number VP200

VOLTAGE SENSOR

Current Ring Indicators



Current Rings are totally self-contained devices for detecting current flow. These devices provide a safe, economical way of indicating the presence of an absence of electrical current flow. The indicator is attached directly to a current-carrying wire. When the current exceeds the turn-on point, the LED will illuminate to indicate the presence of current.

Applications

- Monitor status of heater element
- Observe remote loads
- Indicate phase loss
- Monitor motor operation

Features

- Self-powered
- Red or green indicator
- Easy to install
- Supplied with plastic tie
- Bright yellow case for easy I.D.
- Panel-mounting bracket available

Specifications

Min. turn-on point:
 2 AMPS for CR-45-R
 2.5 AMPS for CR-45-G
 Indicating Range:
 2 to 100 AMPS (for CR-45-R)
 2.5 to 100 AMPS (for CR-45-G)
 Max. Continuous Current:
 100 AMPS

LED Type: T1 3/4 diffused
 LED Color: Red or green
 Case Material: Thermoplastic
 Case Color: Bright safety yellow
 Weight: .5 oz.
 Frequency: 50 – 60 Hz
 Mounting Bracket Material:
 Non-magnetic aluminum

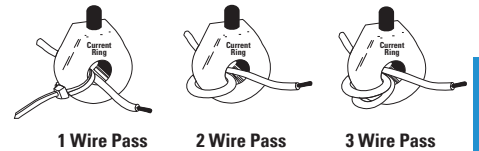
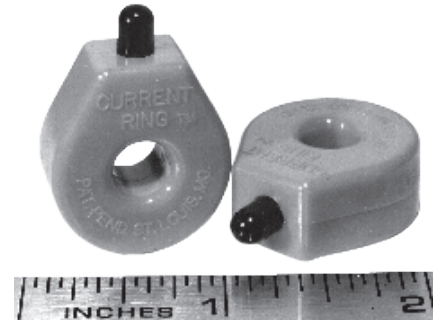
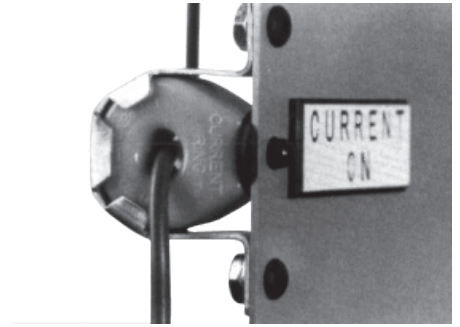

Wire Passes	Turn-On Point		Max. Wire Diameter
	Red	Green	
1	2	2.5	.29
2	1	1.25	.14
3	.66	.83	.13
4	.5	.62	.12
N	2, N	2.5, N	

CURRENT RING INDICATORS

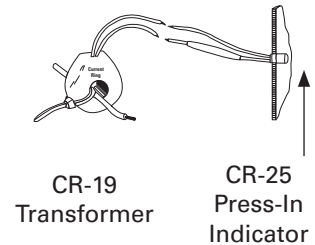

Part Number	Description
CR45R	Current Ring - Red
CR45G	Current Ring - Green
CR19	Current Transformer
CR25	Press-In Indicator
MB45	Mounting Bracket

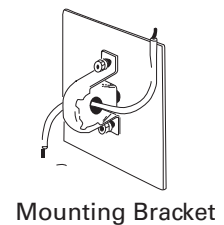



Sound Level Meters

Analog & Digital Sound Level Meters

Check Noise Levels Economically

Features

- Tripod mount ideal for field use
- Analog output for connection to chart recorders, data loggers, etc.
- Selectable weighting ('A' or 'C') and response time (Fast or Slow)
- MAX HOLD front-panel select switch locks highest reading on the display
- Complete with battery

Applications

- Identify noise ordinance violations, traffic noise measurements, community noise measurements, theater acoustic studies, stereo balancing.



Specifications

	407706 Analog SLM	407730 Digital SLM
Range:	54 to 126 dB	40 to 130 dB
Accuracy:	± 3dB @ 94 dB,1000Hz	± 2dB @ 94 dB,1000Hz
Weighting:	'A' and 'C' (Selectable)	'A' and 'C' (Selectable)
Response time:	FAST and SLOW (Selectable)	FAST and SLOW
(Selectable)		
Microphone:	0.5 Electret Condenser Type	0.5 Electret Condenser Type
Analog output:	AC: 0.707 Vrms	AC: 0.707 Vrms
Power supply:	Heavy duty, 9V Battery	(4) AAA batteries
Dimensions:	2.7 x 7.1 x 1.4 (68 x 180 x 36mm)	2.2 x 9 x 1.7 (57 x 230 x 44mm)
Weight:	5.1 oz. (145g)	5.6 oz. (160g)

Digital Sound Level Meter

- Analog bargraph with 50 dB range updates every 40ms
- ± 2dB accuracy with 0.1 dB resolution
- AC analog output
- Complete with microphone wind-screen and four AAA batteries

Digital Sound Level Meter

Part Number 407730

Economical True RMS Multimeter with 11 functions

Features

- Advanced measurements include capacitance, frequency, and duty cycle
- Relative function for establishing a base line reference
- Easy-to-read large 4000 count backlit display
- True RMS AC measurements
- Type K thermometer built-in for surface or air temperature measurements
- Input fuse protection and mis-connection warnings with audible and visible signals
- Auto power off saves battery life
- Data hold freezes current display reading
- Ergonomically designed to fit comfortably in hand
- Protective holster with test lead holder
- Complete with CAT III test leads, multi-position tilt stand, hanging strap, holster with built-in test lead storage, bead wire temperature probe, and 9V battery

Specifications	Range
Basic Accuracy	$\pm 0.3\%$ (VDC)
AC/DC Voltage	0.1mV to 600V (DC/AC)
AC/DC Current	0.1 μ A to 20A
Resistance (Ω)	0.1 Ω to 40M Ω
Capacitance	0.01nF to 100 μ F
Frequency	0.001Hz to 10MHz
Temperature	-4 to 1382°F (-20 to 750°C)
Diode/Continuity	0.1 to 99.9%
Dimensions/Weight	7.4 x 3.2 x 2" (187 x 81 x 50mm)/0.75 lbs (342g)



Part Number:EX430



1000A Clamp Meters

With IR Thermometer



Features

- Autoranging with manual range override
- Data hold, min./max, and auto power off
- Peak hold for inrush currents
- Dimensions: 10.6 x 4.3 x 2, weight 13.6 oz
- AC/DC voltage, resistance, capacitance and frequency
- Complete with test leads, 9V battery and belt holster

Specifications

Display Counts	4000 count backlit LCD
Basic Accuracy	±3% rdg (AC)
AC/DC Volt (max res)	600V (0.1mV)
Resistance (max res)	40MΩ (0.1Ω)
Capacitance (max res)	40mF (0.001nF)

Specifications

Frequency (max res)	4kHz (1Hz)
IR Temp	-58 to 518°F
	-50 to 270°C
Temp. Type K	-4 to 1832°F
(only on EX820)	-20 to 1000°C

Part Number EX810 (average responding)

Part Number EX820 (True RMS and Type K thermocouple temp. probe)